



Les Arts de Marius



SOMMAIRE

01 Verrerie 3 – 83



Chef & Sommelier	4 à 11
OGO	12 à 13
Zwiesel	14 à 17
Luigi Bormioli	18 à 23
RCR	24 à 27
Arcoroc	28 à 35
Bormioli Rocco	36 à 39
Pasabahce	40 à 47
Novastyl	48 à 51
Onis	52 à 53
Barware	54 à 60
Gobelets chopos	61 à 72
Bouteilles Carafe	73 à 78
Photothèque verrerie	79 à 81
Personnalisation sur verre	82 à 83

02 Vaisselle 84 – 173



Personnalisation vaisselle	84 à 85
OGO	88 à 103
ID Fine	104 à 111
Bonna	112 à 121
Novastyl	122 à 135
Porcelaine blanche	136 à 143
Pastas & Salades et Spécialités	144 à 146
Sarreguemines	147
Opal	148 à 151
Vaisselle verre et Saladiers	152 à 154
Plats individuels	155
Ramequins et bols	156 à 157
Coupes à dessert	158 à 159
Mise en bouche	160 à 161
Service à thé et café	162 à 167
Tasses blanches et colorés	168 à 169
Photothèque vaisselle	170 à 173

03 Cuisson 174 – 219



Acier Inoxydable	176 à 185
Aluminium	186 à 191
Fonte émaillée	194
Tajines et Couscous	195 à 196
Émail	197
Cuisson au four - Grès	198
Cuisson au four - Acier carbone	199 à 201
Bacs gastronomiques	202 à 203
Cuisson au four - Verre	204 à 208
Storage	209 à 215
Matériel électrique	216 à 219

04 Couverts 220 – 237



Couverts séries	222 à 233
Couteaux à steak	234 à 235
Cuillères	236
Fruits de mer	237

05 Accessoires et cuisine 238 – 267



Moulins à sel et poivre	239 à 241
Condiments et accessoires	242 à 243
Accessoires de cuisine	244 à 249
Plateaux et services	250 à 251
Accessoires du bar	252 à 257
Sets de table	258 à 259
Couteaux professionnels	260 à 261
Ustensiles de cuisine	262 à 263
Pâtisserie	264
Pesage	265
Ménage	266 à 267

06 Mobilier 268 – 279



Fauteuils de table extérieurs	270
Mobilier extérieur	271 à 273
Fauteuils de table extérieurs	274 à 276
Fauteuils Lounge	277 à 279

07 Index alphabétique 280 à 283 Index numérique 284 à 288





ARCOROC

bonna



COUZON



ID Fine

tehrin

LEIFHEIT

Le Parfait

LUBIANA



Luminarc



novastyl

Now'S HOME FRANCE



OGO LIVING



PYREX

opis



Sareguemines France 1784

SOEHNLE

Tefal



01

VERRERIE



• Chef & Sommelier	4 à 11
• OGO	12 à 13
• Zwiesel	14 à 17
• Luigi Bormioli	18 à 23
• RCR	24 à 27
• Arcoroc	28 à 35
• Bormioli Rocco	36 à 39
• Pasabahce	40 à 47
• Novastyl	48 à 51
• Onis	52 à 53
• Barware	54 à 60
• Gobelets Chopes	61 à 72
• Bouteilles Carafe	73 à 78
• Photothèque verrerie	79 à 81
• Personnalisation sur verre	82 à 83

Chef&Sommelier

MADE IN FRANCE



Le Cristallin extra-fin

Aujourd'hui, Chef&Sommelier™ ouvre un nouveau chapitre avec une évolution majeure de son matériau signature : le Krysta.

Ce cristallin, déjà reconnu pour sa résistance et sa brillance exceptionnelles, atteint désormais une finesse inégalée. Grâce à un procédé de fabrication de pointe, le Krysta EXTRA-FIN permet de créer des verres aux parois, bords et jambes d'une finesse et d'un raffinement incomparables. Cette prouesse technique n'a qu'un seul objectif : sublimer l'expérience de dégustation et amplifier chaque nuance du vin grâce à la sensation délicate du verre.



Bord fin 0,7 mm



Jambe fine 4,5 mm

Pied large 86 mm

Galea

Ce verre, aux courbes généreuses et à la finesse subtile, magnifie les cocktails créés par les mixologues. Avec sa silhouette, fluide et aérienne, plus qu'un simple contenant, c'est une œuvre d'art qui rend hommage à une époque où beauté et fonction étaient intimement liées. Éclat et raffinement.



A.



B.

Code	Ccl	Φ x Ht cm	Sur.	Prix HT
A . 75 11 365	65	10,5 x 25	12	6,89
B . 75 11 364	55	9,3 x 24,4	12	6,37



C.



D.

Code	Ccl	Φ x Ht cm	Sur.	Prix HT
C . 75 11 363	47	8,9 x 23,5	12	6,37
D . 75 11 362	38	8,5 x 21,9	12	6,05



Mylla

La gamme Mylla séduit par son design raffiné et ses courbes parfaitement équilibrées. Chaque verre capte la lumière, mettant en valeur la présentation et transformant chaque dégustation en une expérience visuelle et sensorielle unique : Chambre aromatique large. Angle doux très élégant.



C&S
Chef & Sommelier



A.



B.



C.



D.

Code	Ccl	Φ x Ht cm	Sur.	Prix HT
A . 75 11 356	65	10,5 x 25	12	6,89
B . 75 11 355	55	9,4 x 24,3	12	6,37

Code	Ccl	Φ x Ht cm	Sur.	Prix HT
C . 75 11 354	47	8,9 x 23	12	6,37
D . 75 11 353	38	7,5 x 21,6	12	6,05



MYLLA

Collection by C&S



Open up

Une ligne de verres au design contemporain et révolutionnaire, qui procure un plaisir olfactif sans commune mesure. Elle permet de déguster tous les types de vins jeunes (de 1 à 3 ans pour les blancs et de 1 à 5 pour les rouges). Les différents modèles de la ligne Open Up couvrent la majorité des cépages mondiaux.



A . Tannic



B . Universal



C . Soft



D . Round

Code	Ccl	Φ x Ht cm	Sur.	Prix HT
A . 75 10 941	55	10,7 x 23,3	24	6,64
B . 75 10 929	40	9,1 x 23,1	24	6,29

Code	Ccl	Φ x Ht cm	Sur.	Prix HT
C . 75 10 938	47	10,3 x 22,8	24	6,29
D . 75 10 920	37	9,6 x 21,1	24	6,29



E . Pro tasting



Code	Ccl	Φ x Ht cm	Sur.	Prix HT
E . 75 10 932	32	8,7 x 18	24	5,39



F . Flûte

Code	Ccl	Φ x Ht cm	Sur.	Prix HT
F . 75 10 926	20	7,4 x 23,4	24	6,29

Open Up

Design contemporain et révolutionnaire.



G . FH



H . Warm



I . FB

Code	Ccl	Φ x Ht cm	Sur.	Prix HT
G . 75 06 422	35	7,7 x 11,8	24	3,27
H . 75 06 423	29	9,9 x 8,6	24	5,97

Code	Ccl	Φ x Ht cm	Sur.	Prix HT
I . 75 06 420	38	9,3 x 9,4	24	3,27





Symétrie

Les lignes optiques sur les paraisons des verres offrent un spectacle visuel et les reliefs favorisent l'oxygénation pour un plaisir gustatif garanti.



A.



B.



C.

Code	Ccl	Φ x Ht cm	Sur.	Prix HT
A . 75 11 292	55	9,2 x 26	24	5,09
B . 75 11 291	45	8,7 x 25	24	4,66

Code	Ccl	Φ x Ht cm	Sur.	Prix HT
C . 75 11 290	35	7,8 x 23	24	4,66



D.



E.



F . Flûte



G . Flûte

Code	Ccl	Φ x Ht cm	Sur.	Prix HT
D . 75 11 293	58	10,6 x 20,9	24	5,09
E . 75 11 294	21	11,4 x 18	24	5,54

Code	Ccl	Φ x Ht cm	Sur.	Prix HT
F . 75 11 296	21	6,5 x 24	24	4,88
G . 75 11 295	16	6,5 x 19,8	24	4,23

Sublym

Un verre universel tous cépages. Légèreté dans le mouvement et la forme. Une paraison haute et rétrécie pour accentuer l'élégance du verre et pour une meilleure dégustation. Belle transition entre la paraison et la jambe.



H.



I.



J.



K . Flûte

Code	Ccl	Φ x Ht cm	Sur.	Prix HT
H. 75 10 910	55	9,2 x 26	12	4,62
I . 75 10 911	45	8,7 x 25	12	4,23
I . 75 10 912	35	8 x 23	24	4,23

Code	Ccl	Φ x Ht cm	Sur.	Prix HT
J . 75 10 913	25	7,2 x 20,7	24	4,00
K . 75 10 914	21	7 x 24	24	4,42



Exaltation

Forme consensuelle avec look premium. Jambe étirée et fond piqué.



A .



B .



C . Flûte



Code	Ccl	Φ x Ht cm	Sur.	Prix HT
A . 75 11 338	70	9,6 x 24	12	6,20
A . 75 11 337	55	9,6 x 24	12	4,59
B . 75 11 335	38	8,6 x 21,5	12	4,23

Code	Ccl	Φ x Ht cm	Sur.	Prix HT
B . 75 11 336	47	9,1 x 22,7	12	4,23
C . 75 10 825	30	7,8 x 21,1	24	4,23
C . 75 10 826	35	8,1 x 23,5	24	4,59



Distinction

Distinguée par ses lignes anguleuses, la collection de verres à pied Distinction scénarise avec brio le plaisir de la dégustation des vins jeunes.



D .



E .



F .



G .

Code	Ccl	Φ x Ht cm	Sur.	Prix HT
D . 75 11 282	47	9,6 x 23,3	24	4,23
E . 75 11 281	38	9,1 x 22	24	4,23

Code	Ccl	Φ x Ht cm	Sur.	Prix HT
F . 75 11 280	28	8,3 x 20,7	24	4,00
G . 75 11 283	23	7 x 23,3	24	4,01

Vigne

Coupé à froid, buvant fin.



H . FH



I . FH



J . FH



K . FH



L . FB



M . FB

Code	Ccl	Φ x Ht cm	Sur.	Prix HT
H . 75 06 150	45	7 x 16,5	24	2,82
I . 75 06 153	33	6,9 x 12,6	24	2,62

Code	Ccl	Φ x Ht cm	Sur.	Prix HT
J . 75 06 148	22	6,1 x 11,1	24	2,44
K . 75 06 146	6	4,2 x 9	48	1,31

Code	Ccl	Φ x Ht cm	Sur.	Prix HT
L . 75 06 152	31	8,4 x 8,3	24	2,60
M . 75 06 151	20	7,5 x 7,4	24	2,28

Séquence

La série Séquence est remarquable d'équilibre. Sa paraison de forme tulipe classique trouve sa modernité dans le design à la fois généreux, fin et élancé. Sa jambe bien proportionnée, tout en élégance et pas trop haute est pratique pour les restaurants, les bars à vin et le banqueting.

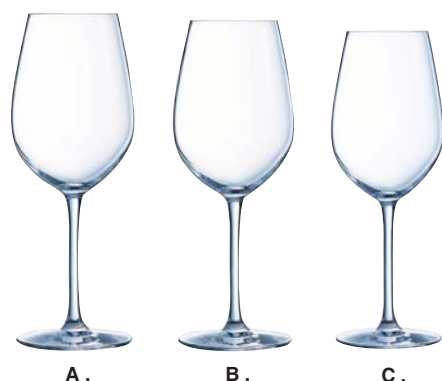

A .

B .

C .

Code	Ccl	Φ x Ht cm	Sur.	Prix HT
A . 75 10 868	53	9 x 23,5	12	4,62
B . 75 10 867	44	8,7 x 22,7	12	4,23
C . 75 10 866	35	7,9 x 21	24	4,23



D . Flûte impérial 24cl

E . Flûte

Code	Ccl	Φ x Ht cm	Sur.	Prix HT
D . 75 11 188	24	7 x 23,5	24	4,00
E . 75 10 865	17	5,6 x 20,8	24	4,00

Evidence

Design équilibré grâce à sa jambe courte pour une efficacité évidente.



F .

G .

H . Flûte

Code	Ccl	Φ x Ht cm	Sur.	Prix HT
F . 75 11 316	35	7,9 x 19	24	3,65
G . 75 11 315	27	7,4 x 18	24	3,44
H . 75 11 318	16	6,2 x 19	24	3,44



Primary

Silhouettes élégantes et galbées, elles distillent sur les tables une ambiance chaleureuse.



I . FH allongé

J . FH classique

Code	Ccl	Φ x Ht cm	Sur.	Prix HT
I . 75 07 390	40	7,6 x 12,7	24	2,62
J . 75 07 161	44	8,7 x 11	24	2,82
J . 75 07 162	36	8,1 x 10,2	24	2,62
J . 75 07 163	27	7,3 x 9,3	24	2,62

Primary color

Sprays mat opaque



K . White

L . Black

Code	Ccl	Φ x Ht cm	Sur.	Prix HT
K . 75 07 396	36	8,1 x 10,2	24	5,00
L . 75 07 395	36	8,1 x 10,2	24	5,00

Primary color

Sprays mat opaque



M . Emerald

N . Jade

Code	Ccl	Φ x Ht cm	Sur.	Prix HT
M . 75 07 397	36	8,1 x 10,2	24	5,00
N . 75 07 398	36	8,1 x 10,2	24	5,00



Vins jeunes

Moderne et efficace avec une grande surface d'oxygénation, cette collection convient aux vins jeunes, rouges et blancs.



A . Jauge naturelle à la cassure 16 cl



B . Jauge naturelle à la cassure 13 cl



C . Jauge naturelle à la cassure 10 cl

Code	Ccl	Φ x Ht cm	Sur.	Prix HT
A . 75 10 447	58	10 x 22	24	4,16
B . 75 10 446	47	9,7 x 21	24	3,82

Code	Ccl	Φ x Ht cm	Sur.	Prix HT
C . 75 10 445	35	9 x 20	24	3,82

Sensation exalt

Élégance et force pour un accord parfait.



D .



E .



F .



G. Flûte

Code	Ccl	Φ x Ht cm	Sur.	Prix HT
D . 75 10 672	41	8,6 x 20,5	24	3,82
E . 75 10 671	31	8 x 19,5	24	3,82
F . 75 10 670	25	7,4 x 18,5	24	3,62

Code	Ccl	Φ x Ht cm	Sur.	Prix HT
F . 75 10 669	20	7 x 18	24	3,62
G . 75 10 673	19	7 x 21	24	3,62



Lima

Gobelet polygonal et contemporain. Fond lourd.



H . Chope FB



I . Chope FH



J . Chope FH



K . Chope FH

Code	Ccl	Φ x Ht cm	Sur.	Prix HT
H . 75 06 238	35	9,4 x 8	24	2,60
I . 75 06 239	38	8,8 x 11	24	2,60

Code	Ccl	Φ x Ht cm	Sur.	Prix HT
J . 75 06 240	45	7,7 x 16	24	2,82
K . 75 06 242	40	7,7 x 13	24	2,60

Cabernet tulip

Cabernet Tulip met en valeur les vins très boisés et d'acidité modérée. Une forme harmonieuse pour tous types de vins. Large choix de capacités.



A.



B.



C.



Code	Ccl	Φ x Ht cm	Sur.	Prix HT
A . 75 10 440	75	10,1 x 25,5	12	4,55
A . 75 10 418	58	9,5 x 23	24	4,16
B . 75 10 417	47	9 x 22	24	3,82

Code	Ccl	Φ x Ht cm	Sur.	Prix HT
C . 75 10 416	35	8,1 x 20,2	24	3,82
C . 75 10 415	25	7,2 x 18	24	3,62
C . 75 10 420	19	6,6 x 16,5	24	3,62



Cabernet jaugé (grappe)

Esthétique et discrète, la jauge est élégante sans trop s'imposer. Cristallin



D . Vins jeunes

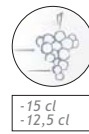

E . Cabernet Tulipe

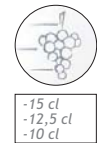

Code	Ccl	Φ x Ht cm	Sur.	Prix HT
D . 75 10 312	35	9 x 20	24	4,34

Code	Ccl	Φ x Ht cm	Sur.	Prix HT
E . 75 10 314	35	8,1 x 20,2	24	4,34

Cabernet ballon

La rondeur favorise la dégustation des vins rouges aromatiques.



F.



G.



H.



I.

Code	Ccl	Φ x Ht cm	Sur.	Prix HT
F . 75 10 424	70	11,5 x 22,1	24	4,55
G . 75 10 423	58	10,6 x 20,9	24	4,16

Code	Ccl	Φ x Ht cm	Sur.	Prix HT
H . 75 10 422	47	10 x 19,6	24	3,82
I . 75 10 421	35	9,1 x 18,2	24	3,82



OGO

Présentation

OGO Living propose une verrerie élégante et durable, pensée pour l'usage quotidien des professionnels.

Des collections épurées en cristallin de haute qualité qui allient design, résistance et fonctionnalité pour sublimer chaque moment à table.



VAP Zénith

ZENITH est un verre cristallin élégant conçu pour sublimer le vin : sa forme met en valeur les arômes, son bord fin offre une sensation délicate et sa jambe élancée lui donne une allure raffinée, idéale pour la dégustation et le service.



A . Grand vin

Code	Ccl	Φ x Ht cm	Sur.	Prix HT
Boîte de 6 verres				
A . 79 35 017	48	8 x 21,5	4	21,90
A . 79 35 016	35	7,2 x 20,5	4	20,75



B . Flûte

Code	Ccl	Φ x Ht cm	Sur.	Prix HT
Boîte de 6 verres				
B . 79 35 015	25	6,5 x 19,5	4	20,40
B . 79 35 018	19	6 x 21,7	4	19,50

OGO

Chopes Zénith

Brillance ultime et tenue parfaite. Modernes et légèrement coniques.



C . FH



D . FB

Code	Ccl	Φ x Ht cm	Sur.	Prix HT
Boîte de 6 verres				
C . 79 35 022	45	7,5 x 15	8	21,10
C . 79 35 021	45	8,5 x 11	8	21,10
D . 79 35 020	35	7,8 x 10,8	8	20,16



Neo

Sensation de la séduction du toucher des lèvres.



E .



F .



G .

Code	Ccl	Φ x Ht cm	Sur.	Prix HT
Boîte de 6 verres				
E . 79 35 047	50	8,8 x 23,6	4	15,95
E . 79 35 046	40	8 x 22,2	4	14,50

Code	Ccl	Φ x Ht cm	Sur.	Prix HT
Boîte de 6 verres				
F . 79 35 045	25	6,8 x 20,5	4	14,30
F . 79 35 048	20	6,5 x 22	4	14,30

OGO



Astral

La collection Astral a été développée pour répondre aux besoins quotidiens des professionnels. Jambe courte pour une meilleure stabilité et un usage intensif. Son aspect flûté procure une élégance et confirme son design raffiné.



A.



B.



C.

Code	Ccl	Φ x Ht cm	Sur.	Prix HT
------	-----	-----------	------	---------

Boîte de 6 verres

A . 79 35 052	50	8,8 x 23,1	8	16,70
B . 79 35 051	40	8 x 22	8	16,20

Code	Ccl	Φ x Ht cm	Sur.	Prix HT
------	-----	-----------	------	---------

Boîte de 6 verres

C . 79 35 050	38	9,2 x 9,8	8	15,15
---------------	----	-----------	---	-------



Oslo

Classique, équilibré et très apprécié pour les tables de tous les jours, verre cristallin stable et solide.



D.



E.



F.



G . Flûte

Code	Ccl	Φ x Ht cm	Sur.	Prix HT
------	-----	-----------	------	---------

Boîte de 6 verres

D . 79 35 027	45	6,6 x 20,8	8	13,95
E . 79 35 026	35	6,3 x 20,1	8	13,30

Code	Ccl	Φ x Ht cm	Sur.	Prix HT
------	-----	-----------	------	---------

Boîte de 6 verres

F . 79 35 025	25	5,5 x 18,8	8	12,75
G . 79 35 028	20	4,9 x 21,1	8	12,80



Mondial

Mondial, l'icône intemporelle : souvent imitée, jamais égalée. L'essentiel des brasseries, bouillons et bouchons.

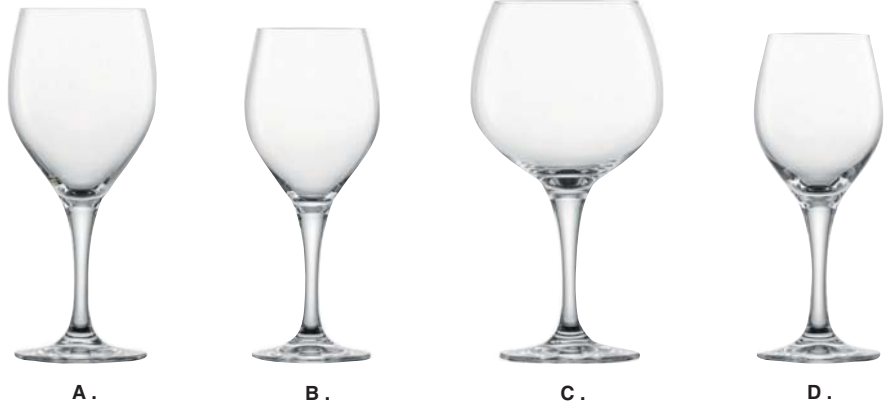

Code	n° - Ccl	Φ x Ht cm	Sur.	Prix HT
A . 75 43 350	1-44,5	8,8 x 20,5	6	4,06
B . 75 43 349	0-33,5	8,1 x 19,7	6	3,75

Code	n° - Ccl	Φ x Ht cm	Sur.	Prix HT
C . 75 43 352	140-61	10,7 x 19,5	6	4,17
D . 75 43 353	2-27	7,5 x 18,7	6	3,75



E . Cocktail

F . Flûte

Code	n° - Ccl	Φ x Ht cm	Sur.	Prix HT
E . 75 43 345	86-27,5	10,4 x 17	6	4,06
F . 75 43 357	7-21	7,2 x 21	6	3,99

Vina

Vina, le choix des sommeliers : durabilité exceptionnelle et expérience de dégustation incomparable.



G . Chope FH

H . Chope FH

I .

J . Flûte

Code	n° - Ccl	Φ x Ht cm	Sur.	Prix HT
G . 75 43 487	79-55,6	9 x 12,7	6	5,22
H . 75 43 481	42-39,7	8,1 x 11,4	6	5,17

Code	n° - Ccl	Φ x Ht cm	Sur.	Prix HT
I . 75 43 479	77-26,3	7 x 21,2	6	5,17
J . 75 43 477	7-22,7	7 x 22,5	6	5,17

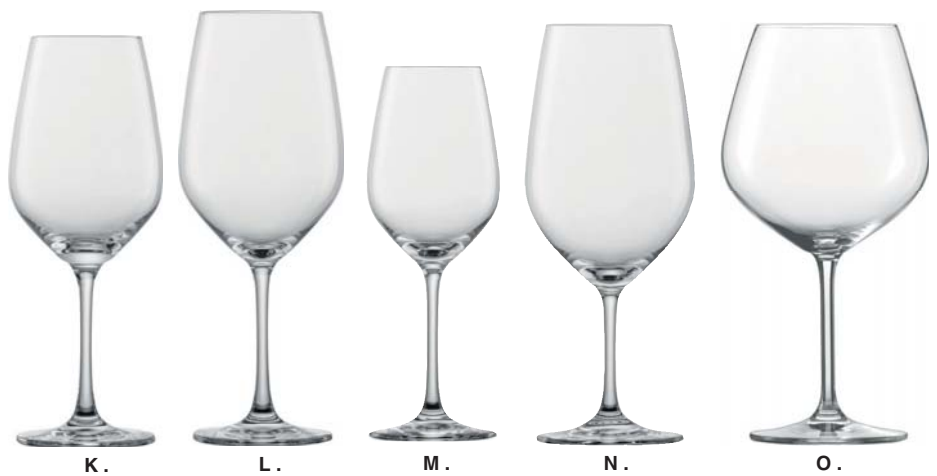

K .

L .

M .

N .

O .

Code	n° - Ccl	Φ x Ht cm	Sur.	Prix HT
K . 75 43 470	0-40,4	8,2 x 21,47	6	5,06
L . 75 43 471	1-51,4	8,8 x 22,7	6	5,18
M . 75 43 475	2-27,9	7,3 x 20,3	6	5,17

Code	n° - Ccl	Φ x Ht cm	Sur.	Prix HT
N . 75 43 472	130-62,6	9,3 x 22,5	6	5,17
O . 75 43 474	140-73,2	11,1 x 22,1	6	5,17

Ivento

Ivento, l'élégance accessible : grands volumes, jambes élancées et une allure raffinée à prix compétitif.

SCHOTT
ZWIESEL

Code	n° - Ccl	Φ x Ht cm	Sur.	Prix HT
A . 75 43 320	140-78	11,1 x 22,1	6	3,99
B . 75 43 321	130-63	9,2 x 23,5	6	3,99
C . 75 43 322	1-50	8,7 x 22,4	6	3,99

Code	n° - Ccl	Φ x Ht cm	Sur.	Prix HT
D . 75 43 323	0-35	7,7 x 20,8	6	3,99
E . 75 43 324	7-23	7 x 22,2	6	3,99

Belfesta / Pure

Belfesta, l'alliance de la polyvalence et du style : silhouette diamantée, jambes longues et une gamme complète pour des tables élégantes.

 ZWIESEL
GLAS

Code	n° - Ccl	Φ x Ht cm	Sur.	Prix HT
F . 75 43 403	130-68	9,4 x 26,7	6	6,23
F . 75 43 400	1-54	9,2 x 24,4	6	6,23
G . 75 43 401	0-41	8,4 x 23,2	6	6,23
G . 75 43 402	2-30	7,6 x 22	6	5,87

Code	n° - Ccl	Φ x Ht cm	Sur.	Prix HT
H . 75 43 404	140-69,2	11,4 x 23,4	6	6,23
H . 75 43 409	145-46,5	9,8 x 22,2	6	6,23
I . 75 43 410	7-20,9	7,2 x 25,2	6	5,87
I . 75 43 412	77-29,7	7,2 x 23,4	6	6,23

Code	n° - Ccl	Φ x Ht cm	Sur.	Prix HT
J . 75 43 429	42-35,7	7 x 14,4	6	5,21
K . 75 43 437	89-30,6	8,9 x 8,3	6	5,21
K . 75 43 433	60-38,9	9,6 x 9	6	5,21

 ZWIESEL
GLAS

La note de musique

TRITAN® GLASS
PROTECT

Tritan Crystal Glass

Résistance - Éclat - Éléance

Le processus de fabrication renforce les 3 zones sensibles : le buvant, le haut et la base du pied du verre.

Extrêmement résistant à la casse, aux rayures et à la brisure.

Favorit

Favorit, le verre incontournable des bistros : conçu pour la bistronomie et les bars.

SCHOTT
ZWIESEL

The One

design audacieux et stabilité hors pair grâce à son centre de gravité abaissé.



L . Favorit

Code	Ccl	Φ x Ht cm	Sur.	Prix HT
L . 75 43 626	27	7,2 x 18,1	6	2,70



M . The One

Code	Ccl	Φ x Ht cm	Sur.	Prix HT
M . 19 71 747	41,3	9 x 21,1	6	25,47
M . 19 71 748	32	8 x 19	6	21,93

Boîte de 6 verres

SENSA

Collection by ZWIESEL



Sensa gamme d'arômes typique

ZWIESEL
GLAS



Taste

La jambe est très bien étirée, la finesse du verre est unique. Pour les fins gourmets, une série intemporelle.



A.

B.

C.

D.

E.

Code	n°-Ccl	Φ x Ht cm	U.V	Prix HT
A . 75 43 491	140-79	11,1 x 22,7	1/6	4,75
B . 75 43 490	130-65,6	9,6 x 23,7	1/6	4,75
C . 75 43 492	1-49	8,7 x 22,5	1/6	4,85

Code	n°-Ccl	Φ x Ht cm	U.V	Prix HT
D . 75 43 493	0-35,6	7,9 x 21,1	1/6	4,85
E . 75 43 496	0-28,3	7 x 23,1	1/6	4,95

Ever / Classico

Le raffinement et la simplicité de ces verres solides conviennent à une multitude d'événements.



F.

G.

H.

Code	n°-Ccl	Φ x Ht cm	U.V	Prix HT
F . 75 43 076	0-40,8	8,2 x 22,5	1/6	5,45
F . 75 43 081	2-31,2	7,5 x 21	1/6	4,46
G . 75 43 077	1-54,5	9 x 24	1/6	5,35

Code	n°-Ccl	Φ x Ht cm	U.V	Prix HT
G . 75 43 078	130-64,5	7,5 x 21	1/6	5,35
H . 75 43 080	140-81,4	11,6 x 23	1/6	5,45

Sensus

Dégustation à l'aveugle.



I . Sensus noir

Code	Ccl	Φ x Ht cm	U.V	Prix HT
I . 75 43 549	29,9	7,5 x 18,2	1/6	6,45



J . Crachoir

Code	Φ x Ht cm	U.V	Prix HT
J . 75 43 551	15,8 x 27,2	1	60,40



Sensa

Chaque forme correspond à un arôme ou à un style de vin.



K.

L.

Code	Ccl	Φ x Ht cm	Sur.	Prix HT
K . 75 43 171	53	8,8 x 23,6	6	6,85
K . 75 43 172	36	7,6 x 22,2	6	6,85
L . 75 43 174	50	8,4 x 12	6	6,72



Propriété du verre Ultra Clair Sparkx®



Verre Ultra Clair résistant, sans métaux lourds, conforme à la norme ISO/PAS IWA 8 : 2009. Jambe tirée dans la même goutte de verre que la paraison (pas de joints ni coutures). Bord mince coupé laser. Jambe renforcée Titane. Grande résistance. Garantie à plus de 2.000 cycles de lavage industriel sans altération de la transparence et de la brillance. Eco-respectueux (sans plomb ni autres métaux lourds).

Traitement Titane

TITANIUM Reinforced Procédé de renforcement nanotechnologique à base de titane en application directe sur la jambe. Il durcit considérablement la surface du verre et augmente sa résistance à l'abrasion (évite les micro-rayures des jambes à terme). Résistance de la jambe à la rupture augmentée de 140 %. Parfaitement incolore et transparent.

Rubino

Le verre œnologique pratique pour la table et la dégustation.



A . Eau

Code	Ccl	Φ x Ht cm	Sur.	Prix HT
A . 75 36 127 37		8,1 x 18,1	24	4,07
A . 75 36 125 27		7,3 x 17,1	24	3,94



Michelangelo

Le verre à jambe tirée d'inspiration artistique en verre ultra clair. Soufflé mécanique, bord mince et résistant.



B . Eau



C . Vin



D . Flûte

Code	Ccl	Φ x Ht cm	Sur.	Prix HT
B . 75 36 009 34		8,2 x 18,8	24	4,29
B . 75 36 010 22,5		7,3 x 17,5	24	3,85

Code	Ccl	Φ x Ht cm	Sur.	Prix HT
C . 75 36 011 19		6,7 x 16,6	24	3,59
D . 75 36 014 16		6,4 x 18,5	24	3,94



D.O.C

Le verre de table "œnologue".



E . Dream



F . Coupe



H .

Code	Ccl	Φ x Ht cm	Sur.	Prix HT
E . 75 36 105 14		6 x 17	2	3,40
F . 75 36 015 22		9,5 x 14	24	4,20

Code	Ccl	Φ x Ht cm	Sur.	Prix HT
H . 75 36 041 21,5		6,5 x 15,5	24	3,52
H . 75 36 042 31		7,3 x 17,4	24	4,07

Mixology

Une ligne au design vintage et raffiné. La présentation et la rondeur ludique enivreront vos soirées bar.



A . Nick&Nora



B . Coupe



C . Martini

Code	Ccl	Φ x Ht cm	Sur.	Prix HT
A . 75 36 247	15	6,9 x 14,7	24	3,59
B . 75 36 249	22,5	9,5 x 14	24	4,39
C . 75 36 248	21,5	10,4 x 17,2	24	5,38



D . Gin tonic



E . Spritz



F . Cognac

Code	Ccl	Φ x Ht cm	Sur.	Prix HT
D . 75 36 251	80	11,9 x 20,5	12	6,52
E . 75 36 250	57	9,1 x 22,5	24	5,66
F . 75 36 255	46	9,7 X 12,7	12	5,72

Diamante

Pour une décoration ludique, vintage et raffinée et une joyeuse animation de votre bar !



G . Gin tonic



H . Eau et vin



I . Flûte



J . Chope FH

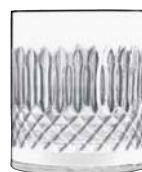

K . Chope FB

Code	Ccl	Φ x Ht cm	Sur.	Prix HT
G . 75 36 268	65	11 x 22,3	24	6,80
H . 75 36 267	52	9,4 x 23,5	24	6,34
H . 75 36 266	38	8,5 x 21,5	24	5,81

Code	Ccl	Φ x Ht cm	Sur.	Prix HT
I . 75 36 265	22	7 x 23,6	24	5,76
J . 75 36 269	48	7,2 x 15,7	24	6,32
K . 75 36 253	38	8,4 x 9,6	24	5,03



Bach

Design vintage et tendance, élégant et raffiné, allié à la jambe tirée renforcée titane et aux qualités du cristallin SON.hyx®

Lugli Bormioli
MADE IN ITALY

SON.hyx®



A . Cocktail



B . Fizz



C . Gin tonic



D . Vin



Code	Ccl	Φ x Ht cm	Sur.	Prix HT
------	-----	-----------	------	---------

A . 75 36 473	26	11,3 x 18,5	16	6,56
B . 75 36 477	26	9,7 x 15,7	16	5,42

Code	Ccl	Φ x Ht cm	Sur.	Prix HT
------	-----	-----------	------	---------

C . 75 36 476	60	10,7 x 20,1	16	6,25
D . 75 36 468	28	7 x 20,6	24	5,74



E . Eau



F . Flûte

Code	Ccl	Φ x Ht cm	Sur.	Prix HT
------	-----	-----------	------	---------

E . 75 36 467	40	7,7 x 22	24	6,14
F . 75 36 469	21	5,3 x 23,5	24	5,47



G . Chope FH
à facettes fond lourd :
design scandinave



H . Chopes FB
à facettes fond lourd :
design scandinave

Code	Ccl	Φ x Ht cm	Sur.	Prix HT
------	-----	-----------	------	---------

G . 75 36 472	36	6,4 x 15,5	24	4,42
H . 75 36 470	25,5	7,5 x 9	24	4,26
H . 75 36 471	33,5	8,25 x 9,7	24	4,77



SON.hyx®

TITANIUM Reinforced

ACCADEMIA Lugli Bormioli
MADE IN ITALY

Le cristallin SON.hyx®

Cristallin soufflé mécanique sans plomb haute technologie. Jambe tirée dans la même goutte de verre que la paraison (pas de joints ni coutures), bord mince coupé laser. Brillant, parfaitement incolore et transparent (totalement perméable à la lumière). Haute sonorité grande résistance. Garantie à plus de 4.000 cycles de lavages industriels.

Supremo

L'aboutissement de recherches en design et créativité. Supremo allie l'extrême raffinement aux plus grandes qualités de la dégustation. Transparence parfaite, brillance éclatante, sonorité et résistance du cristallin SON.hyx®

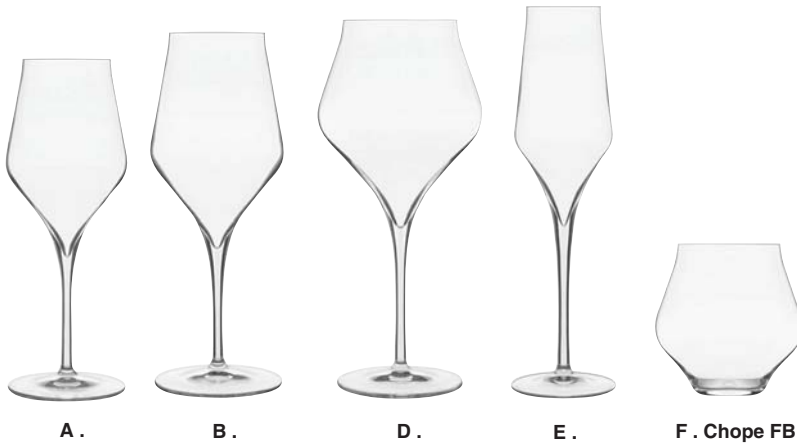

Code	Ccl	Φ x Ht cm	Sur.	Prix HT	Code	Ccl	Φ x Ht cm	Sur.	Prix HT
A . 75 36 460	35	8,1 x 22,1	24	5,50	D . 75 36 458	65	11 x 24,5	12	6,58
B . 75 36 459	45	8,8 x 23,3	24	5,76	E . 75 36 461	24	6,4 x 25	24	5,15
B . 75 36 462	55	9,5 x 24,3	12	6,14	F . 75 36 463	45	10 x 9,8	24	3,62

Roma 1960

Le charme et la volupté italienne des bars 60's : la bague en taille «panier» encercle le bas des paraissons.



Code	Ccl	Φ x Ht cm	Sur.	Prix HT	Code	Ccl	Φ x Ht cm	Sur.	Prix HT
G . 75 36 258	55	9 x 22,2	24	5,72	I . 75 36 262	30	8 x 8,4	24	4,64
H . 75 36 264	24	7 x 24,4	24	4,96	J . 75 36 263	40	7 x 14,2	24	5,03

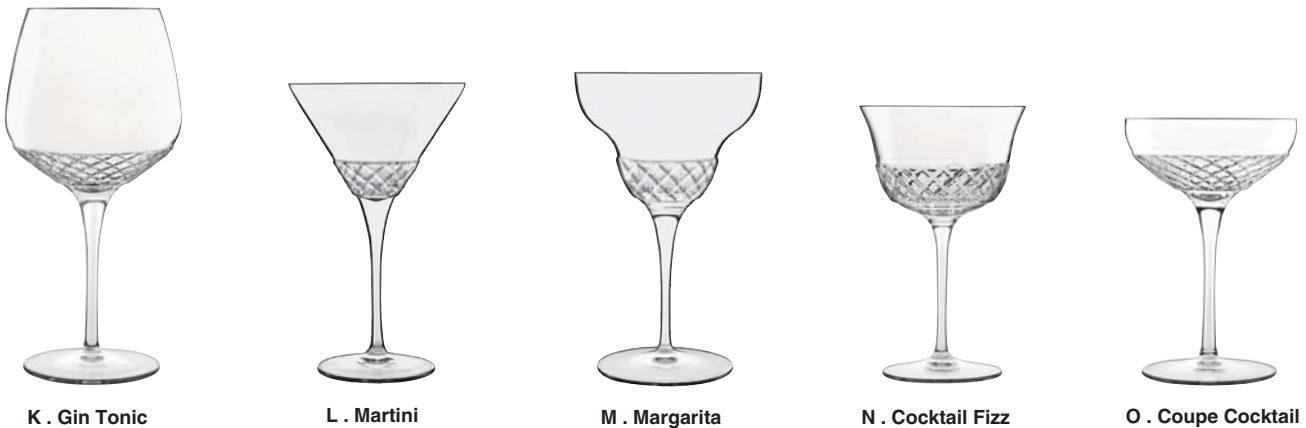

Code	Ccl	Φ x Ht cm	Sur.	Prix HT	Code	Ccl	Φ x Ht cm	Sur.	Prix HT	Code	Ccl	Φ x Ht cm	Sur.	Prix HT
K . 75 36 259	80	11,4 x 23,5	12	6,42	M . 75 36 261	39	11,4 x 18,4	12	6,23	N . 75 36 256	26	9,6 x 15,7	24	5,15
L . 75 36 260	22	10,4 x 17,2	24	5,62						O . 75 36 257	30	11,3 x 15	12	6,00

MIXOLOGY

Collection by Bormioli Luigi



L'art de sublimer les cocktails

Luigi Bormioli
MADE IN ITALY

Backdoor '20s

Des courbes généreuses pour un enivrement immédiat et une dégustation agréable de vos boissons.

Luigi Bormioli
MADE IN ITALY

SON
hygiene

VERRERIE



A . Barracuda



B . Great Gastby



C . Hemingway



D . Nick Nora



E . Gin Tonic



F . Tequila

Code	Ccl	Φ x Ht cm	Sur.	Prix HT
A . 75 36 290	32	8,1 x 20	12	5,13
B . 75 36 289	30	10,5 x 16,2	12	5,13

Code	Ccl	Φ x Ht cm	Sur.	Prix HT
C . 75 36 288	25	10,5 x 16	12	5,63
D . 75 36 287	17	8,6 x 14,6	12	4,63

Code	Ccl	Φ x Ht cm	Sur.	Prix HT
E . 75 36 291	80	8,6 x 23,5	12	6,84
F . 75 36 292	42	7,3 x 19,8	12	5,63

Speakeasy

Le jeu de lumière et de lignes sur une forme épurée pour compléter Meravigliosi.

Luigi Bormioli
MADE IN ITALY

SON
hygiene



G . Vin blanc / Eau pétillante



H . Coupe



J . FB

Code	Ccl	Φ x Ht cm	Sur.	Prix HT
G . 75 36 566	55	9,3 x 22,7	24	7,98
H . 75 36 564	30	10,7 x 14,8	24	7,98

Code	Ccl	Φ x Ht cm	Sur.	Prix HT
J . 75 36 559	40	9,5 x 10,2	24	7,53



Meravigliosi

Une nouvelle forme simple et parfaite.



K . Coupe



L . Sauterne



M . Chardonnay



N . Cabernet



O . Flûte

Code	Ccl	Φ x Ht cm	Sur.	Prix HT
K . 75 36 556	30	10,7 x 14,8	24	4,99
L . 75 36 551	35	8 x 20,3	24	3,91
M . 75 36 550	45	8,8 x 21,6	24	4,42

Code	Ccl	Φ x Ht cm	Sur.	Prix HT
N . 75 36 554	70	10,7 x 24,3	24	5,34
O . 75 36 555	40	7,8 x 24,5	24	4,35



Timeless

Une ligne intemporelle au style moderne et incomparable, inspirant les professionnels pour les cocktails et spiritueux.



A . FH



B . FB



C . FB

Code	Ccl	Φ x Ht cm	Sur.	Prix HT
Boîte de 6 verres				
A . 19 46 261	44	7,6 x 15	2	28,68
B . 19 46 260	36	8,6 x 9,2	2	24,48

Code	Ccl	Φ x Ht cm	Sur.	Prix HT
Boîte de 6 verres				
C . 19 46 259	31	8,3 x 8,6	2	23,61



D . Martini



E . Spritz



F . Cocktail

Code	Ccl	Φ x Ht cm	Sur.	Prix HT
Boîte de 6 verres				
D . 19 46 271	21	10,3 x 18	2	32,14
E . 19 46 270	36	9,6 x 22	2	30,51

Code	Ccl	Φ x Ht cm	Sur.	Prix HT
Boîte de 4 verres				
F . 19 46 273	50	10,3 x 20,8	2	25,91



G . Calice



H . Eau



I . Vin



J . Flûte

Code	Ccl	Φ x Ht cm	Sur.	Prix HT
Boîte de 6 verres				
G . 19 46 272	26	10 x 16,7	2	34,64

Code	Ccl	Φ x Ht cm	Sur.	Prix HT
Boîte de 6 verres				
H . 19 46 263	30	8,9 x 20,9	2	34,64
I . 19 46 262	23	8,1 x 20	2	30,51

Code	Ccl	Φ x Ht cm	Sur.	Prix HT
Boîte de 6 verres				
J . 19 46 264	21	7,1 x 23,8	2	34,64

RCR



Présentation

RCR puise son origine au fond de la Toscane (Italie), en 1967, fabrication 100% dans l'usine. Issue de la tradition verrière italienne (verres pressés et soufflés), RCR s'est créé autour de la tradition artisanale locale. Grâce à ses nouveautés, RCR consolide son image avec un accent de modernité et de créativité. La gamme RCR a un succès fort en Europe depuis plusieurs années avec des gammes intemporelles mais aussi fonctionnelles, pratiques et tendance.

Le verre RCR

La collection forme une alchimie entre Barware Mixology et verres de table : des verres solides qui trouvent leur place sur toutes les tables.



TRASPARENCE



BRILLANCE



RÉSISTANCE



LAVABLE AU LAVE-VAISSELLE



SONORITÉ



RECYCLABLE

Luxion® Crystal Glass :

Tous les produits sont fabriqués en Luxion®, le crystal glass breveté et recyclable à l'infini de RCR. L'utilisation d'oxydes nobles dans sa formule assure un haut niveau de qualité immédiatement visible à l'œil nu et perceptible dans la force, la transparence, la brillance et la sonorité des produits

Certifications:

ISO 9001 : 2015

ISO 14001 : 2015

Tattoo

Une ligne jeune, avec un style contemporain qui rappelle les lignes esthétiques du Body Art.



A . FH



B . FB



C . Mixing

Code	Ccl	Φ x Ht cm	Sur.	Prix HT
Boîte de 6 verres				
A . 19 46 372	37	7 x 15	2	28,68
B . 19 46 371	34	8,2 x 9,4	2	24,48

Code	Ccl	Φ x Ht cm	Sur.	Prix HT
C . 19 46 365	65	9,7 x 16	4	18,15



D . Calice



E . Coupette

Code	Ccl	Φ x Ht cm	Sur.	Prix HT
Boîte de 6 verres				
D . 19 46 373	29	8,8 x 19,4	2	34,64
E . 19 46 375	27	10 x 14	2	34,64



Stack

Empilables au design moderne.



F . FH



G . FB

Code	Ccl	Φ x Ht cm	Sur.	Prix HT
Boîte de 6 verres				
F . 19 46 028	39	8,3 x 14,1	2	29,37
G . 19 46 027	31	8,9 x 9,5	2	25,71

Alkemist

D'inspiration des sculptures de pierres précieuses pour une ligne unique et inimitable. Le style des années 30 pour magnifier l'apéritif et les cocktails.



A.

B.



C.

D.

Code	Ccl	Φ x Ht cm	Sur.	Prix HT
------	-----	-----------	------	---------

Boîte de 6 verres

A . 19 46 187	58	10,8 x 20,8	2	36,62
B . 19 46 188	53	10 X 22,5	2	39,16

Code	Ccl	Φ x Ht cm	Sur.	Prix HT
------	-----	-----------	------	---------

Boîte de 6 verres

C . 19 46 186	38	8,7 x 9,5	2	26,68
D . 19 46 185	35	8,7 x 10,3	2	29,18

Etna

Etna s'inspire de la puissance de l'éruption du volcan sicilien. La parfaite imperfection de la nature est gravée sur les décors qui caractérisent verres et gobelets : la lumière se reflète sur les gravures se multipliant sur plusieurs niveaux, accentuant la transparence exceptionnelle.



E . Chope FH



F . Chope FB

Code	Ccl	Φ x Ht cm	Sur.	Prix HT
------	-----	-----------	------	---------

Boîte de 6 verres

E . 19 46 214	34	7 x 15	2	29,37
---------------	----	--------	---	-------

Code	Ccl	Φ x Ht cm	Sur.	Prix HT
------	-----	-----------	------	---------

Boîte de 6 verres

F . 19 46 213	33	8 x 9,5	2	25,71
---------------	----	---------	---	-------



G .



H .



I . Flûte

Code	Ccl	Φ x Ht cm	Sur.	Prix HT
------	-----	-----------	------	---------

Boîte de 6 verres

G . 19 46 216	28	8,5 x 19	2	35,51
H . 19 46 215	20	8 x 18,5	2	30,91

Code	Ccl	Φ x Ht cm	Sur.	Prix HT
------	-----	-----------	------	---------

Boîte de 6 verres

I . 19 46 217	19	7 x 22,5	2	35,51
---------------	----	----------	---	-------





Tiki

Cocktail esprit anciens peuples italiens.
2 nouveautés en 2016



A . Pulcinella
(lot de 4)



B . Venezia
(lot de 4)



D . Sardinia
(lot de 4)



E . Etruria
(lot de 4)

Code	Ccl	Φ x Ht cm	Sur.	Prix HT
------	-----	-----------	------	---------

Boîte de 4 verres

A . 19 46 032	45	7,6 x 13,6	2	34,44
B . 19 46 033	45	7,6 x 13,6	2	34,44

Code	Ccl	Φ x Ht cm	Sur.	Prix HT
------	-----	-----------	------	---------

Boîte de 4 verres

D . 19 46 025	46	7,6 x 13,6	2	34,44
E . 19 46 026	45	7,6 x 13,6	2	34,44

Melodia

Une ligne éternelle, rassurante et polyvalente.
Le style mixologie donne de la structure à la table et à tous les styles de cocktail.



E . Chope FH



F . Chope FB



G . Eau

Code	Ccl	Φ x Ht cm	Sur.	Prix HT
------	-----	-----------	------	---------

Boîte de 6 verres

E . 19 46 246	36	7 x 15	2	28,68
F . 19 46 245	31	8,2 x 9,4	2	24,48

Code	Ccl	Φ x Ht cm	Sur.	Prix HT
------	-----	-----------	------	---------

Boîte de 6 verres

G . 19 46 249	27	8,7 x 20,2	2	34,64
---------------	----	------------	---	-------



H . Vin



I . Liqueur



J . Flûte

Code	Ccl	Φ x Ht cm	Sur.	Prix HT
------	-----	-----------	------	---------

Boîte de 6 verres

H . 19 46 248	21	8,2 x 19	2	30,51
I . 19 46 247	6	9 x 15	2	30,51

Code	Ccl	Φ x Ht cm	Sur.	Prix HT
------	-----	-----------	------	---------

Boîte de 6 verres

J . 19 46 250	16	7 x 22,2	2	34,64
---------------	----	----------	---	-------



VINA & V.JULIETTE

Collections by ARCOROC



une taille qui offre un grand confort de dégustation.

ARCOROC

ARCOROC

MADE IN FRANCE

CRYSTAL GLASS HIGH QUALITY

Cela fait partie du quotidien et de chaque service. Arcoroc créer des produits d'art de la table depuis 1958

En 2026, un nouveau chapitre s'ouvre pour Arcoroc avec le lancement du verre en Cristallin de haute qualité : raffinement et robustesse pour les lieux où le style se mêle à l'art du service.

CRYSTAL GLASS HIGH QUALITY

Arcoroc a développé une gamme de solutions d'art de la table innovantes et fonctionnelles, conçues pour un usage intensif en restauration.



- 1) Résistance supérieure
- 2) Transparence totale
- 3) Acoustique parfaite
- 4) Brillance durable



Disco

Design aux fines lignes lumineuses, inspirer des reflets festifs avec une élégance contemporaine, Disco magnifie les couleurs des boissons.

ARCOROC
CRYSTAL GLASS HIGH QUALITY



A . Gin Tonic

Code	Ccl	Φ x Ht cm	Sur.	Prix HT
A . 75 11 345	60	10 x 21,5	12	4,27
B . 75 11 346	18	7,5 x 17	12	3,77



B . Nick & Nora



C . Coupe

Code	Ccl	Φ x Ht cm	Sur.	Prix HT
C . 75 11 347	21	9 x 16	12	3,77



D . PH

Code	Ccl	Φ x Ht cm	Sur.	Prix HT
D . 75 06 512	45	8,5 x 13,5	12	2,36
E . 75 06 511	38	9,5 x 9	12	2,36



E . FB



F . FB

Code	Ccl	Φ x Ht cm	Sur.	Prix HT
F . 75 06 510	32	9 x 8,5	12	2,15

New products
Nouveautés



V. Juliette

La forme angulaire simple et légère sur un verre d'une très grande transparence à bord mince proche du cristallin.

ARCOROC

CRYSTAL GLASS HIGH QUALITY



A .



B .



C . Jaugé Grappe

Code	Ccl	Φ x Ht cm	Sur.	Prix HT
A . 75 10 355	50	9,2 x 21,7	24	3,58
A . 75 10 356	40	8,6 x 20,6	24	3,58

Code	Ccl	Φ x Ht cm	Sur.	Prix HT
B . 75 10 357	30	7,9 x 18,8	24	3,28
C . 75 10 313	30	7,9 x 18,8	24	3,82



D . Flûte



E . Gobelet FH léger



F . Gobelet FB léger

Code	Ccl	Φ x Ht cm	Sur.	Prix HT
D . 75 10 358	23	6,5 x 21,7	24	3,28

Code	Ccl	Φ x Ht cm	Sur.	Prix HT
E . 75 06 432	40	8,7 x 11	24	2,02
F . 75 06 430	35	9,4 x 8,3	24	2,02



Magnifique

Très proche du cristallin, une forme généreuse. Idéal pour le vin au verre. Bord mince et grande pureté. Deux tailles désormais.

ARCOROC

CRYSTAL GLASS HIGH QUALITY



G .



H .

Code	Ccl	Φ x Ht cm	Sur.	Prix HT
G . 75 10 962	47	9,7 x 22,7	12	3,57

Code	Ccl	Φ x Ht cm	Sur.	Prix HT
H . 75 10 961	35	9 x 21	24	3,28

Broadway et Broadway bleu

Collection remise au goût du jour ! Elle joue avec les lumières des bars et des pubs.
Verre non trempé.

ARCOROC
CRYSTAL
GLASS
HIGH QUALITY



K . VAP Table



L . Martini



M . Gin



N . Coupe

Code	Ccl	Φ x Ht cm	Sur.	Prix HT
K . 75 11 513	25	8,9 x 18,8	24	4,81
L . 75 11 510	21	11,8 x 15,5	24	5,05

Code	Ccl	Φ x Ht cm	Sur.	Prix HT
M . 75 11 512	58	10,7 x 19,5	24	5,47
N . 75 11 511	25	11,5 x 13,8	24	4,81



■ Teintée dans la masse



H . Chope FH



H . Chope FH



I . Chope FB



J . Bleu



J . Mauve

Code	Ccl	Φ x Ht cm	Sur.	Prix HT
H . 75 07 306	38	7,5 x 14,5	24	3,63
H . 75 07 303	28	6,75 x 13,4	24	3,11

Code	Ccl	Φ x Ht cm	Sur.	Prix HT
I . 75 07 304	30	8,45 x 9,1	24	3,09

Code	Ccl	Φ x Ht cm	Sur.	Prix HT
J . 75 07 329	30	8,45 x 9,1	24	3,39
J . 75 07 328	30	8,45 x 9,1	24	3,39

West Loop

Design iconique. Aspect cristal taillé Longchamp très serré : brillance sur table ou dans les bars.
Jambe travaillée, sculptée finement.
Collection conçue pour des cocktails surprenants.

ARCOROC
CRYSTAL
GLASS
HIGH QUALITY



K . Vap Eau



L . Flûte



M . Vodka



N . Gobelet FH



O . Gobelet FB

Code	Ccl	Φ x Ht cm	Sur.	Prix HT
K . 75 10 813	25	7,4 x 18,2	12	4,55
L . 75 10 814	14	5,3 x 20,5	12	4,55
M . 75 11 213	27	11,3 x 16,8	12	5,70

Code	Ccl	Φ x Ht cm	Sur.	Prix HT
N . 75 06 477	36	7,5 x 13,5	12	3,91
O . 75 06 476	32	8,4 x 9,5	12	3,51

Vina

La paraison tulipée. Un classique pour tous les vins.

ARCOROC



A.



B.



C. Gin



D. Splendid

Code	Ccl	Φ x Ht cm	Sur.	Prix HT
A . 75 10 028	58	9,3 x 23	24	3,66
A . 75 10 033	47	8,8 x 21,9	24	3,20
B . 75 10 032	36	8 x 20,2	24	3,20
B . 75 10 031	26	7,2 x 18	24	2,97

Code	Ccl	Φ x Ht cm	Sur.	Prix HT
C . 75 10 043	70	11,3 x 19,5	12	4,17
D . 75 10 806	58	10,6 x 20,9	24	3,66



E. Flûte



F. Chope FH



G. Chope FB

Viticole

ARCOROC

Verre non trempé.



H. Viticole



I. Viticole

Code	Ccl	Φ x Ht cm	Sur.	Prix HT
E . 75 10 034	19	5,5 x 22,5	24	2,97

Code	Ccl	Φ x Ht cm	Sur.	Prix HT
F . 75 06 033	36	7,6 x 12,1	24	1,82
G . 75 06 032	34	8,9 x 8,3	24	1,82

Code	Ccl	Φ x Ht cm	Sur.	Prix HT
H . 75 11 024	31	7,2 x 17,5	6	3,20
H . 75 11 029	21,5	6,5 x 15,5	24	2,53
I . 75 11 028	12	5,4 x 13,1	6	2,36

Equip Home

Luminarc

Verre non trempé.



J.



K.
Flûte

Code	Ccl	Φ x Ht cm	Sur.	Prix HT
J . 10 29 831	35	6,4 x 19,2	24	2,45
J . 75 10 829	24	7 x 16,9	24	2,05
J . 75 10 830	19	5,3 x 15,4	24	1,90
K . 75 10 831	17	6 x 17,5	24	2,05

Ballon

ARCOROC

Verre non trempé.



L.

Code	Ccl	Φ x Ht cm	Sur.	Prix HT
L . 75 10 012	25	8,4 x 13,8	24	2,22
L . 75 10 013	19	7,7 x 13	24	2,10

Roman

Luminarc

Verre non trempé.



M.



N.

Code	Ccl	Φ x Ht cm	Sur.	Prix HT
M . 75 10 380	21,5	8,0 x 11,7	24	2,45
N . 75 10 381	14	7,1 x 10,4	24	2,30



Silhouette

Capacités et épaisseur du verre. Taille réduite pour le restauration rapide.



A.



B.



C. Flûte

Code	Ccl	Φ x Ht cm	Sur.	Prix HT
A . 75 11 328	47	9,2 x 19,4	24	3,21
A . 75 11 327	31	8,2 x 17,1	24	3,21
A . 75 11 326	25	8,2 x 17,1	24	2,97

Code	Ccl	Φ x Ht cm	Sur.	Prix HT
B . 75 11 325	19	7 x 15,3	24	2,76
C . 75 11 329	18	6,4 x 18,1	24	2,98

Élégance

Verre non trempé.



D . Eau



E . Vin rouge



F . Vin blanc / Porto



G . Coupe



H . Flûte



I . Hurrigan

Code	Ccl	Φ x Ht cm	Sur.	Prix HT
D . 75 11 260	31	8,1 x 18	36	3,21
D . 75 11 258	24,5	7,4 x 16,6	48	2,97
E . 75 11 262	19	6,9 x 15,3	48	2,76
Emballages promotion cartons 48 verres				
D . 75 10 701	24,5	7,4 x 16,6	48	2,74
E . 75 10 702	19	6,9 x 15,3	48	2,42

Code	Ccl	Φ x Ht cm	Sur.	Prix HT
F . 75 11 263	14,5	6,4 x 14,2	48	2,50
F . 75 11 264	12	5,9 x 13,4	48	2,50
F . 75 10 065	6,5	4,8 x 11,3	48	2,35
G . 75 11 270	16	9,0 x 12,2	48	3,21

Code	Ccl	Φ x Ht cm	Sur.	Prix HT
H . 75 11 266	10	4,7 x 15,9	48	2,50
H . 75 11 267	13	4,7 x 17,9	48	2,76
H . 75 11 269	17	5,5 x 17,5	48	2,98
I . 75 10 059	44	7,9 x 20,7	24	6,59

Savoie

ARCOROC

Verre non trempé.

L .
Eau
/ VinM .
PortoN .
Flûte

Code	Ccl	Φ x Ht cm	Sur.	Prix HT
L . 75 10 035	24,5	7,4 x 15,2	48	2,24
L . 75 10 036	19	6,9 x 14	48	2,09
M . 75 10 037	14,5	6,4 x 13,4	48	1,91
N . 75 10 040	17	6,1 x 17	48	2,24





Elisa

Verre trempé Arcoroc.

ARCOROC

EXTRA RESISTANT FULLY TEMPERED GLASS



A.



B.



C.



D. Flûte

Code	Ccl	Φ x Ht cm	Sur.	Prix HT
A . 75 10 614	30	7,64 x 19,4	24	3,51
B . 75 10 615	23	7,2 x 17,6	48	3,28

Code	Ccl	Φ x Ht cm	Sur.	Prix HT
C . 75 07 147	23	7,1 x 8,2	24	1,61
D . 75 10 617	17	5,3 x 19,2	48	3,28



Amélia

Verre trempé empilable Arcoroc.

EXTRA RESISTANT FULLY TEMPERED GLASS

PERFECTLY STACKABLE



D.



E.



F.

Code	Ccl	Φ x Ht cm	Sur.	Prix HT
D . 75 10 537	25	7,9 x 11,7	48	3,9
E . 75 10 536	19	7,2 x 10,6	48	2,98

Code	Ccl	Φ x Ht cm	Sur.	Prix HT
F . 75 10 535	16	6,1 x 10,1	48	2,98



Normandie

Verre trempé Arcoroc.

EXTRA RESISTANT FULLY TEMPERED GLASS



G.



H.



I. Flûte

Code	Ccl	Φ x Ht cm	Sur.	Prix HT
G . 75 10 500	23	7,4 x 16,2	48	3,52
H . 75 10 501	16,5	6,7 x 14,5	48	3,33
I . 75 10 504	15	5,4 x 17,3	48	3,33

Emballages cartons 12/48

Code	Ccl	Φ x Ht cm	Sur.	Prix HT
G . 75 10 800	23	7,4 x 16,2	48	3,43
H . 75 10 801	16,5	6,7 x 14,5	48	3,12
I . 75 10 804	15	5,4 x 17,3	48	3,12

Emballages cartons 48 verres



Domaine

Adaptée pour le banqueting, Domaine est une collection ergonomique, solide, un excellent rapport qualité prix. Verre trempé.

ARCOROC

EXTRA
RESISTANT
FULLY TEMPERED GLASS



A .

Code	Ccl	Φ x Ht cm	Sur.	Prix HT
A . 75 10 948	47	9 x 22,4	12	3,73



B .

Code	Ccl	Φ x Ht cm	Sur.	Prix HT
B . 75 10 947	37	8,3 x 20,2	24	3,50
B . 75 10 946	27	7,6 x 18,2	24	3,28

Princesa

Verre trempé Arcoroc.



C .



D .



E . Flûte

Code	Ccl	Φ x Ht cm	Sur.	Prix HT
C . 75 10 605	31	7,4 x 19,7	24	3,48
D . 75 10 606	23	6,7 x 17,4	6	3,28

Code	Ccl	Φ x Ht cm	Sur.	Prix HT
D . 75 10 607	19	6,9 x 16,5	6	3,01
E . 75 10 610	15	5 x 19,6	24	3,01

EXTRA
RESISTANT
FULLY TEMPERED GLASS



Linéal

Jambe haute chic, forme anguleuse et verre trempé : Linéal est la ligne contemporaine des restaurateurs pointilleux. Elle marie l'élégance de leur finesse à leur résistance supérieure.

EXTRA
RESISTANT
FULLY TEMPERED GLASS



F .

Code	Ccl	Φ x Ht cm	Sur.	Prix HT
F . 75 10 750	31	8,2 x 19,7	24	3,51



G .

Code	Ccl	Φ x Ht cm	Sur.	Prix HT
G . 75 10 751	25	7,7 x 17,4	24	3,28
G . 75 10 752	19	7 x 16,5	24	3,01

Tre sensi

TRE SENSI est la deuxième étape du projet In Alto. Développée en étroite collaboration avec l'Association italienne des Sommeliers (AIS), Tre Sensi est une ligne de verres à pied incontournable pour dégustation œnologique : une parfaite transparence du verre et une large paraison pour laisser tous les arômes s'exalter.



A . B . C . D . Flûte E . Flûte professional

Code	Ccl	Φ x Ht cm	Sur.	Prix HT
A . 75 34 482	55	9,2 x 23,5	24	6,67
B . 75 34 481	43	8,5 x 22	24	5,75
C . 75 34 480	30,5	7,7 x 20,4	24	5,22

Code	Ccl	Φ x Ht cm	Sur.	Prix HT
D . 75 34 433	21,5	5,9 x 20	24	4,14
E . 75 34 430	15	6,9 x 18,5	6	3,36



Uno chopes

Ses lignes épurées et contemporaines, la transparence et la sonorité du verre, sont de véritables atouts pour votre table.



Code	Ccl	Φ x Ht cm	Sur.	Prix HT
F . 75 34 457	44,5	9,1 x 10,25	24	3,38
G . 75 34 462	35	8,5 x 9,5	24	2,99



F . Gobelet FB G . Gobelet FB



Aurum

Le style italien s'invite enfin à votre table : laissez le charme agir ! Le design contemporain et géométrique d'Aurum stimule l'oxygénation du vin et la libération des arômes. Une gamme complète de verres à pied en cristallin (brillance, étincellance et sonorité) assortie au gobelet pour une dégustation optimale et un service irréprochable.



H . I . J . Flûte K . Chope FB

Code	Ccl	Φ x Ht cm	Sur.	Prix HT
H . 75 34 400	52	9,3 x 22,5	12	6,03
I . 75 34 401	43	8,9 x 21,3	12	5,47

Code	Ccl	Φ x Ht cm	Sur.	Prix HT
I . 75 34 402	35	8,3 x 20,3	12	5,31
J . 75 34 404	23	6,8 x 23,5	12	5,18
K . 75 34 406	37,5	8,25 x 9,5	12	3,11

Nexo

L'élégance à l'état pur grâce à son design contemporain. En verre cristallin Star Glass, une jambe étirée et un buvant taillé au laser. Une collection parfaitement étudiée pour un service à table et la dégustation.



L .

Code	Ccl	Φ x Ht cm	Sur.	Prix HT
L . 75 34 636	45	8,8 x 20,9	24	5,18
L . 75 34 635	38	8,3 x 20	24	4,78

Celebrazione

L'esthétique vintage des verres faits main, enrichis de découpe et d'ornements. Pour une dégustation élégante et raffinée.



A . Flûte



B . Eau & Vin



New products
Nouveautés

Code	Ccl	Φ x Ht cm	Sur.	Prix HT
A . 75 34 672	21	7,5 x 22,1	12	3,70

Code	Ccl	Φ x Ht cm	Sur.	Prix HT
B . 75 34 671	25,5	7,8 x 20,1	12	3,59
B . 75 34 670	29	8,2 x 20,6	12	3,61

America'20s

Une ligne de verres à pied (en cristallin) et gobelet inspirés des années 20 qui apporte une note vintage à la table.



C . Gin tonic



D . Cocktail



E . Martini



F . Coupe cocktail



G . FB

Code	Ccl	Φ x Ht cm	Sur.	Prix HT
C . 75 34 288	74	10,9 x 22,6	12	7,41
D . 75 34 290	25	7,8 x 20,2	12	5,13

Code	Ccl	Φ x Ht cm	Sur.	Prix HT
E . 75 34 289	25	10,8 x 18	12	6,03
F . 75 34 287	23	9,8 x 14,7	24	5,18

Code	Ccl	Φ x Ht cm	Sur.	Prix HT
G . 75 34 286	38	8,8 x 9,2	36	3,73
G . 75 34 283	30	8,4 x 8,4	24	3,22

Florian

Les crêtes douces en forme de pétale sur des tiges richement sculptées. Jambe travaillée à facettes, bord fin coupé au laser.



H . Eau



I . Vin



J . Cocktail



K . Flûte



L . FB

Code	Ccl	Φ x Ht cm	Sur.	Prix HT
H . 75 34 643	38	8,2 x 25	24	4,65
I . 75 34 644	24,5	7,2 x 19,8	24	4,12
J . 75 34 646	24	9,7 x 16,4	12	4,23

Code	Ccl	Φ x Ht cm	Sur.	Prix HT
K . 75 34 645	21	6,5 x 22	24	4,07
L . 75 34 641	37,5	7,8 x 11,3	24	3,31



Exclusiva

L'effet optique des facettes rend les verres parfaitement brillants. 3 Tailles de carafe.



A . FH



A . FH



B . Carafe



B . Carafe



C . Vin

Code	Ccl	Φ x Ht cm	Sur.	Prix HT
A . 75 34 382	21,5	8,2 x 5,9	12	1,98
A . 75 34 383	35,5	8,5 x 9	12	2,28
A . 75 34 384	50	8,9 x 12	24	2,60

Code	Ccl	Φ x Ht cm	Sur.	Prix HT
B . 75 34 387	25	6,7 x 16,5	12	4,83
B . 75 34 388	50	8,3 x 20,4	6	6,95
B . 75 34 389	100	10,2 x 22,5	6	9,82

Code	Ccl	Φ x Ht cm	Sur.	Prix HT
C . 75 34 386	37,4	6,2 x 20	24	4,83

Cocktail Glass

Rondeur pour dégustation raffinée, des calices rétro !



D . Meravigliosi



E . Cocktail Novecento



F . Nick and Nora



G . Fizz Novecento

Code	Ccl	Φ x Ht cm	Sur.	Prix HT
D . 75 36 556	30	10,7 x 14,8	24	4,99
E . 75 34 437	25	9,4 x 15,5	24	4,55

Code	Ccl	Φ x Ht cm	Sur.	Prix HT
F . 75 34 107	15,5	7,4 x 15,5	24	3,70
G . 75 34 438	22	9 x 12,4	24	4,03



Bartender

Bords minces et jambe courte pour la dégustation de bières.



H .



I .

Code	Ccl	Φ x Ht cm	Sur.	Prix HT
H . 75 34 665	52	8,1 x 23,9	18	5,41
I . 75 34 664	40,5	7,5 x 22,4	24	4,42
I . 75 34 663	28	6,6 x 20,6	24	4,01



La trempe Bormioli Rocco



Le processus de la trempe consiste à soumettre le verre encore chaud (environ 600°C) à un vrai choc thermique brutal et très rapide (environ 20°C) au moyen d'un jet d'air comprimé sur toute la surface du produit.

Cette étape dans la production confère au produit une extra robustesse aux chocs thermiques et mécaniques.

Le verre trempé présente des caractéristiques intéressantes qui le rendent 2,5 fois plus résistant qu'un verre sodocalcique et dure 10 fois plus longtemps.

En cas de casse, le verre trempé contrairement aux autres verres, se brise en fragments non dangereux.



Barshine

Concept abouti pour la table et le petit déjeuner. Le verre trempé garantit la sécurité pour les boissons chaudes.



A . Tasse 31,5cl



B . Tasse 25cl



C . Chope FH



D . Chope FB

Code	Ccl	Φ x Ht cm	Sur.	Prix HT
A . 75 34 615	31,5	7,9 x 11,3	12	2,39
B . 75 34 614	25	7,1 x 8	12	2,23
B . 75 34 612	8,9	5,7 x 6,5	12	1,82

Code	Ccl	Φ x Ht cm	Sur.	Prix HT
C . 75 34 623	38	8,3 x 12,1	24	3,22
D . 75 34 622	39,5	9,1 x 10,1	36	2,77
D . 75 34 621	30,5	8,4 x 9,2	36	2,51
D . 75 34 613	21	7,6 x 8,4	24	2,25



New kalix / Milano

Avec un parfait équilibre des lignes, New Kalix combine le raffinement et l'extra robustesse.

Collection complétée avec les trois seules chopes forme boule en verre trempé existant sur le marché.



E . Eau / Vin Milano



F . Flûte



G . Chope boule FH



H . Chope boule FB

Code	Ccl	Φ x Ht cm	Sur.	Prix HT
E . 75 34 200	35	8,4 x 18,9	12	4,82
E . 75 34 201	27	7,8 x 18	12	3,84
F . 75 34 204	17	5,8 x 19,6	12	3,80

Code	Ccl	Φ x Ht cm	Sur.	Prix HT
G . 75 34 208	40	7,5 x 13	12	2,60
H . 75 34 205	38	8,9 x 9,2	12	2,60
H . 75 34 206	30	8,2 x 8,5	12	2,36

Colosseo

Forte résistance aux chocs mécaniques et thermiques. Verres trempés empilables.



I .



J .

Code	Ccl	Φ x Ht cm	Sur.	Prix HT
I . 75 29 070	28	6,8 x 13,7	24	3,74
J . 75 29 071	22	6,2 x 12,4	24	3,58

Nonix

Verre trempé empilable



K .



L .

Code	Ccl	Φ x Ht cm	Sur.	Prix HT
K . 75 30 033	58	9 x 15	12	1,96
L . 75 30 032	29	7,4 x 11,5	12	1,42





Timeless

Indémoudables, les calices Timeless sont des pièces majestueuses, artistiques et solides.



A . Coupe glace



B . Bodega



C . Eau



D . Calice 35



E . Gin Tonic

Code	Ccl	Φ x Ht cm	Sur.	Prix HT
<u>Boîte de 2 verres</u>				
A . 16 11 582	28	9,8 x 10,3	12	4,96
<u>Boîte de 4 verres</u>				
B . 16 13 216	22,5	9 x 5,4	6	8,51

Code	Ccl	Φ x Ht cm	Sur.	Prix HT
<u>Boîte de 4 verres</u>				
C . 16 13 189	32	8,7 x 15	6	13,46
D . 16 13 192	35	8,75 x 19,6	6	13,74

Code	Ccl	Φ x Ht cm	Sur.	Prix HT
<u>Boîte de 4 verres</u>				
E . 16 13 193	55	8,5 x 19,8	2	18,92



F . Nick and Nora



G . Martini



H . Coupe



I . Flûte

Code	Ccl	Φ x Ht cm	Sur.	Prix HT
<u>Boîte de 4 verres</u>				
F . 16 13 224	16	8 x 13,5	6	15,01
G . 16 13 191	23	11,6 x 17,2	6	17,54

Code	Ccl	Φ x Ht cm	Sur.	Prix HT
<u>Boîte de 4 verres</u>				
H . 16 13 186	27	10,8 x 15,7	4	16,61
I . 16 13 188	17,5	6,4 x 22,5	4	13,40



Timeless

Trois chopes coniques viennent compléter la gamme avec la contenance 36cl droite tube.



A . FH Conique



B . FH Conique



C . FB Conique



D . FB



E . FB



F . FB

Code	Ccl	Φ x Ht cm	Sur.	Prix HT
------	-----	-----------	------	---------

Boîte de 4 verres

A . 16 13 228	47	6,8 x 14,3	6	16,16
B . 16 13 227	36	6 x 14,7	6	13,28

Code	Ccl	Φ x Ht cm	Sur.	Prix HT
------	-----	-----------	------	---------

Boîte de 4 verres

C . 16 13 226	35	7,3 x 9,7	6	13,63
D . 16 13 223	34,5	8,6 x 9,6	6	11,56

Code	Ccl	Φ x Ht cm	Sur.	Prix HT
------	-----	-----------	------	---------

Boîte de 4 verres

E . 16 13 215	21	7,4 x 8,3	6	8,51
F . 16 13 214	6	4,8 x 6,2	12	6,21



G . FH Tube 36



H . FH



I . FH

Code	Ccl	Φ x Ht cm	Sur.	Prix HT
------	-----	-----------	------	---------

Boîte de 4 verres

G . 16 13 225	36,5	7,2 x 15,3	6	10,52
H . 16 13 218	45	7,8 x 16,1	6	13,00

Code	Ccl	Φ x Ht cm	Sur.	Prix HT
------	-----	-----------	------	---------

Boîte de 4 verres

I . 16 13 217	30	6,8 x 14,3	6	10,70
---------------	----	------------	---	-------



J . Broc



K . Mixing

Code	Ccl	Φ x Ht cm	Sur.	Prix HT
------	-----	-----------	------	---------

J . 75 41 313	140	10,6 x 21,7	6	12,42
---------------	-----	-------------	---	-------

Code	Ccl	Φ x Ht cm	Sur.	Prix HT
------	-----	-----------	------	---------

K . 75 41 318	72	10,5 x 14,5	6	7,19
---------------	----	-------------	---	------

ELYSIA

Collection by Pasabahce



Parfait pour servir des spiritueux



Estrella

Facettée, un diamant taillé dans la base du verre.



La mixology

Certains designs sont intemporels, ils traversent les âges en restant toujours d'actualité.

Devenu un classique de la Mixology, Timeless donne aussi un caractère au service de table.

Solide en verre mécanique, la gamme est désormais complète pour toutes les occasions.

Avec les mêmes qualités que Timeless, Elysia est intentionnellement glamour.

La seule présence d'Elysia sur la table donnera des paillettes à votre événement.



A . Eau

B . Gin Tonic



C . Martini

D . Calice

Code	Ccl	Φ x Ht cm	Sur.	Prix HT
A . 75 41 553	34	8,7 x 19,5	4	2,65
B . 75 41 552	49	10 x 19,8	12	4,03

Code	Ccl	Φ x Ht cm	Sur.	Prix HT
C . 75 41 554	21	11,6 x 17,2	4	3,51
D . 75 41 555	25	11 x 15,7	4	3,38



Elysia

Majestueuses et inclassables, High Society. Verre mécanique très solide.



E . Shot

F . FB

G . FB

H . FH

I . FH

Code	Ccl	Φ x Ht cm	Sur.	Prix HT
Boîte de 4 verres				
E . 16 13 084	6	4,5 x 6,6	4	9,66
F . 16 13 086	21	7,3 x 8,5	6	8,96
G . 16 13 087	36	8,4 x 9,8	6	11,96

Code	Ccl	Φ x Ht cm	Sur.	Prix HT
Boîte de 4 verres				
H . 16 13 088	28	6,5 x 14	6	10,80
I . 16 13 081	45	7,6 x 15	6	13,36



J . Martini



K . Coupe



L . Gin Tonic

Code	Ccl	Φ x Ht cm	Sur.	Prix HT
Boîte de 4 verres				
J . 16 13 083	22	11,6 x 17,2	6	18,34

Code	Ccl	Φ x Ht cm	Sur.	Prix HT
Boîte de 4 verres				
K . 16 13 085	26	10,1 x 16,4	6	16,80
L . 16 13 082	50	10,1 x 19,8	6	19,80

Verres à pied

Joy

Design rétro mais contemporain, une collection dynamique et élégante. Verre mécanique.

Pasabahçe
LIVE BEAUTIFUL



A . Gin tonic



B . Cocktail



C . Coupe



D . Flûte



E . Cognac



F . Chope FH

Code	Ccl	Φ x Ht cm	Sur.	Prix HT
------	-----	-----------	------	---------

Boîte de 4 verres

A . 16 13 380	50	10,5 x 21	2	16,75
B . 16 13 382	22	11,8 x 16	2	15,40

Code	Ccl	Φ x Ht cm	Sur.	Prix HT
------	-----	-----------	------	---------

Boîte de 4 verres

C . 16 13 381	25	12,1 x 14,7	2	14,40
D . 16 13 383	17,5	6,7 x 22	6	13,05

Code	Ccl	Φ x Ht cm	Sur.	Prix HT
------	-----	-----------	------	---------

Boîte de 4 verres

E . 16 13 379	26	8,5 x 12,9	6	11,95
F . 16 13 378	36	8,4 x 13,1	6	12,20

Amber et Essence

6 calices définis pour chaque utilité. Verre mécanique solide pied plaqué.

Pasabahçe
LIVE BEAUTIFUL



G . Bourgogne



H . Bordeaux



I . Risus



J . Bière



K . Flûte



L . Chope



M . Montecarlo

Code	Ccl	Φ x Ht cm	Sur.	Prix HT
------	-----	-----------	------	---------

G . 16 13 063	47,5	10 x 21,5	6	1,98
H . 16 13 062	46	9 x 22	6	1,85
I . 16 13 061	45,5	10 x 19,5	6	1,74

Code	Ccl	Φ x Ht cm	Sur.	Prix HT
------	-----	-----------	------	---------

J . 16 13 060	40,5	8 x 18	6	1,83
K . 16 13 064	19	6,5 x 22,5	6	1,35

Code	Ccl	Φ x Ht cm	Sur.	Prix HT
------	-----	-----------	------	---------

L . 16 13 065	35	8 x 10	6	1,46
M . 75 41 222	39	7,8 x 11	24	1,90



Tulip

Tradition et robustesse d'une série toujours d'actualité. Trois chopes cocktails complètent la gamme.

Pasabahçe
LIVE BEAUTIFUL



N .



O .



P . Flûte



Q . Cocktail Capri

Code	Ccl	Φ x Ht cm	Sur.	Prix HT
------	-----	-----------	------	---------

N . 75 41 281	31	7,6 x 17	24	1,44
O . 75 41 282	24	7,1 x 16,5	24	1,38
O . 75 41 283	20	6,5 x 15,5	24	1,09

Code	Ccl	Φ x Ht cm	Sur.	Prix HT
------	-----	-----------	------	---------

P . 75 41 285	20	6,5 x 20,5	24	1,50
Q . 75 41 120	38,5	7,4 x 17,6	24	2,45

Savage

Inspirée par le célèbre mixologue, SIMPLE est beau, pur, clair et transparent. Verre cristallin.



A . Coupe



B . Coupe



C . Pony



D . FH



E . FB



E . FB



E . FB

Code	Ccl	Φ x Ht cm	Sur.	Prix HT
A . 75 41 593	22	10,8 x 17,5	24	5,02
B . 75 41 592	17	10 x 16,7	6	4,62
C . 75 41 589	13,5	7,2 x 16,5	6	3,96

Code	Ccl	Φ x Ht cm	Sur.	Prix HT
D . 75 41 588	33	6,7 x 14,5	24	3,72
E . 75 41 587	29	8,5 x 7,5	24	3,61

Caldéra



Ligne épurée avec des motifs en V distinctifs. Verre cristallin.

Code	Ccl	Φ x Ht cm	Sur.	Prix HT
D . 75 41 574	32,5	8,9 x 9,1	24	xxx
E . 75 41 573	28,5	6,9 x 15,1	24	xxx

Finesse

SIMPLE est utilisable, propre, épuré, délicat, au féminin comme au masculin.



F . FH



G . FB

Code	Ccl	Φ x Ht cm	Sur.	Prix HT
F . 75 41 580	35	6 x 14	6	2,73
G . 75 41 581	39	8 x 9	6	2,46
G . 75 41 579	30	7,5 x 8	6	2,20

J .
Water
SavageK .
Pure

Code	Ccl	Φ x Ht cm	Sur.	Prix HT
J . 75 41 595	26	8 x 8	6	3,61
K . 75 41 583	25	7,5 x 9,5	6	2,88



Allegra Focus

La courbure moderne à la cassure parfaite.
Verre mécanique solide.



Code	Ccl	Φ x Ht cm	Sur.	Prix HT
A . 75 41 631	49	9,1 x 21,8	24	3,19
B . 75 41 630	35	7,5 x 21,7	6	2,98

Code	Ccl	Φ x Ht cm	Sur.	Prix HT
C . 75 41 632	42	8,9 x 10,9	24	2,13



Allegra

La courbure moderne à la cassure parfaite. Verre mécanique solide.

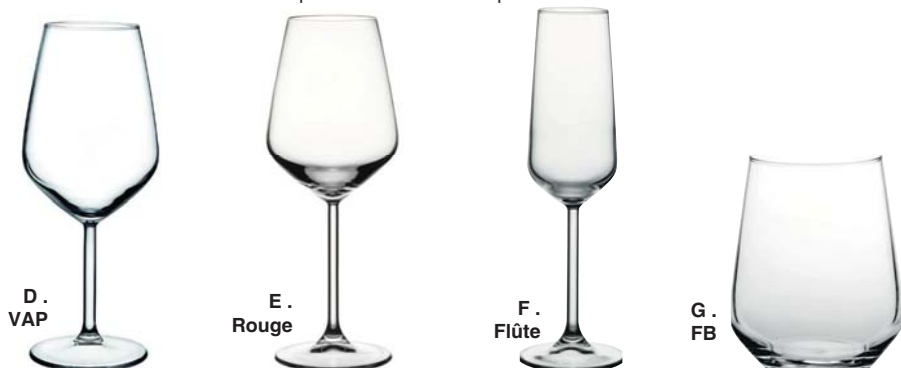

Code	Ccl	Φ x Ht cm	Sur.	Prix HT
D . 75 41 616	49	9,1 x 21,8	6	2,53
E . 75 41 618	35	7,3 x 21,7	6	2,46

Code	Ccl	Φ x Ht cm	Sur.	Prix HT
F . 75 41 619	19,5	7 x 22,6	6	2,53
G . 75 41 615	42,5	8,9 x 10,9	24	1,76

Code	Ccl	Φ x Ht cm	Sur.	Prix HT
H . 75 41 260	55	9,8 x 21,4	6	2,55

Ambassador



Grands volumes pour les amoureux de la rondeur.
Verre mécanique solide.



Tower - Nonic



Verres empilables trempé.

Tester

Verre mécanique.

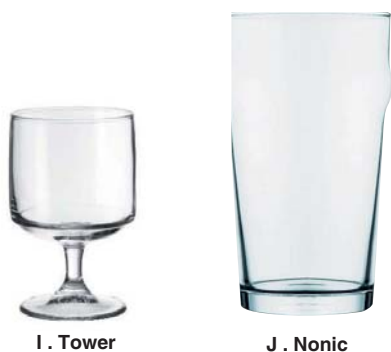

Code	Ccl	Φ x Ht cm	Sur.	Prix HT
I . 75 41 092	22	7 x 11,2	12	1,45
J . 75 41 180	56	8,5 x 15	24	1,44



Code	Ccl	Φ x Ht cm	Sur.	Prix HT
K . 75 41 115	21,5	7 x 15,5	12	1,44

Enotéca



Deux formes de verres raffinés, fins, aux grands volumes pour la dégustation de grands vins.



Code	Ccl	Φ x Ht cm	Sur.	Prix HT
L . 75 41 251	65,5	8,5 x 21,6	24	3,85
M . 75 41 250	55	8,2 x 23,2	24	3,39

New products
Nouveautés

Comptoir

Verre unique raffiné et solide



A.

Code	Ccl	Φ x Ht cm	Sur.	Prix HT
<u>Lot de 6 verres</u>				
A . 16 13 027	31	5,9 x 13,2	6	6,45

Ivory

Convexe, court et solide.



B.



C.



D.

Code	Ccl	Φ x Ht cm	Sur.	Prix HT
<u>Lot de 3 verres</u>				
B . 16 18 596	49	9,7 x 23	24	5,43
C . 16 18 595	33,5	8,6 x 20,5	18	5,04

Code	Ccl	Φ x Ht cm	Sur.	Prix HT
<u>Lot de 3 verres</u>				
D . 16 18 597	22,5	6,9 x 22,6	12	5,04

**Impérial**

Verre mécanique renforcé pied plaqué, buvant trempé.



E.



F.



G . Flûte (lot de 3)



H . Chope FB

Code	Ccl	Φ x Ht cm	Sur.	Prix HT
E . 75 41 072	34	7 x 18	24	1,75
F . 75 41 073	25	6,2 x 16,9	48	1,45
F . 75 41 074	20	6 x 16	24	1,40

Code	Ccl	Φ x Ht cm	Sur.	Prix HT
G . 16 13 630	21	6,4 x 21,5	8	4,85
H . 75 41 077	31	7,8 x 8,7	48	1,55

**Bistro / Paris**

Classique équilibré, son pied plaqué et sa taille basse en font un verre adapté à toutes les tables.

I . Vin
EauJ . Flûte
(lot de 3)

Code	Ccl	Φ x Ht cm	Sur.	Prix HT
I . 75 41 065	26	8,2 x 16	24	1,44
I . 75 41 066	21	7,6 x 14,7	24	1,14
J . 16 13 630	21	6,4 x 21,5	8	4,85

Banquet

Verre mécanique



K . VAP

Code	Ccl	Φ x Ht cm	Sur.	Prix HT
K . 75 41 033	19	8 x 14,8	12	1,14
<u>Lot de 10 verres</u>				
K . 16 13 041	19	8 x 14,8	1	9,72

novastyl

Novastyl

Découvrez une gamme exceptionnelle de verrerie alliant savoir-faire traditionnel et techniques modernes.

Notre collection inclut différents verres cristallin, gobelets et chopes à bière tous conçus pour des occasions spécifiques.

Nos produits, durables et de haute qualité, embellissent votre table et répondent aux besoins des professionnels et particuliers.

Chaque pièce est une œuvre d'art prête à illuminer vos moments précieux.

Inao

Verre cristallin sophistiqué.



A.

Code	Ccl	Φ x Ht cm	Sur.	Prix HT
Boîte de 6 verres				
A . 19 71 885	21	6,5 x 16	8	12,05

Pied vert

Verre cristallin sophistiqué.



B.

Code	Ccl	Φ x Ht cm	Sur.	Prix HT
Lot de 3 verres				
B . 19 71 890	16,5	6,5 x 16	6	10,50

Rondo

Empilable et solide

Tower

Verre trempé empilable



C.



D.

Code	Ccl	Φ x Ht cm	Sur.	Prix HT
Lot de 3 verres				
C . 16 18 070	21	7,5 x 9	6	3,50
C . 16 18 152	25	8 x 10	6	3,75
Lot de 4 verres				
D . 16 13 310	22	7 x 11,2	4	6,04

Matignon

Verre cristallin sophistiqué.



E.



F.



G. Flûte

Code	Ccl	Φ x Ht cm	Sur.	Prix HT
Lot de 3 verres				
E . 19 71 816	23	7 x 16	16	6,44
F . 19 71 815	19	7 x 15,2	16	6,44
Lot de 3 verres				
G . 19 71 817	18	5,3 x 17,5	16	6,44



novastyl

Glen

Verre mécanique solide.



H. FH



I. FB

Code	Ccl	Φ x Ht cm	Sur.	Prix HT
Lot de 6 verres				
H . 16 18 291	35,5	7 x 14,5	6	15,00
I . 16 18 290	33	8,4 x 9	6	13,50

Sand

Rondeur et volume en verre solide mécanique



J. Gobelet



K. Gobelet

Code	Ccl	Φ x Ht cm	Sur.	Prix HT
Boîte de 4 verres				
J . 16 18 331	40,5	9,3 x 9,4	6	6,30
K . 16 18 332	51	7,6 x 14,5	6	6,70

Bonita

Multi-usage en verre solide mécanique



L. Gobelet



M. Gobelet

Code	Ccl	Φ x Ht cm	Sur.	Prix HT
Boîte de 4 verres				
L . 16 18 333	24	8,2 x 5,8	6	4,55
M . 16 18 334	34,5	8,4 x 8,8	6	5,15



Noa

Verre mécanique solide

Verres à pied



A .



B .



C . Flûte

Code	Ccl	Φ x Ht cm	Sur.	Prix HT
<u>Lot de 3 verres</u>				
A . 16 18 832	44	9,5 x 21,5	8	6,90
B . 16 18 833	33	8,5 x 20,5	8	5,92

Code	Ccl	Φ x Ht cm	Sur.	Prix HT
<u>Lot de 3 verres</u>				
C . 16 18 834	23	6 x 22,5	8	5,92



Florence

Design élancé en verre mécanique solide



D .



E .



F . Flûte



G .

Code	Ccl	Φ x Ht cm	Sur.	Prix HT
<u>Lot de 3 verres</u>				
D . 16 18 375	33	8,2 x 20,6	6	5,74
E . 16 18 376	29,5	7,5 x 19,2	8	5,50

Code	Ccl	Φ x Ht cm	Sur.	Prix HT
<u>Lot de 3 verres</u>				
F . 16 18 377	23	6,4 x 22,5	8	5,50
G . 16 18 371	34	8,6 x 8,5	8	4,28

Cognac

Verre mécanique

Cocktail

Verre mécanique



H .



I .

Code	Ccl	Φ x Ht cm	Sur.	Prix HT
H . 16 13 430	39	9 x 12,5	24	1,55
<u>Lot de 2 verres</u>				
I . 16 18 257	64,5	11 x 20,4	12	4,38

Belek

Pinte en verre mécanique



J .

Brasseur

Verre mécanique



K .

Code	Ccl	Φ x Ht cm	Sur.	Prix HT
J . 16 18 396	58	8 x 16	12	1,85
<u>Lot de 3 verres</u>				
K . 16 11 480	40	7,2 x 20,5	6	5,79

Tulipe

Verre mécanique



L .

Code	Ccl	Φ x Ht cm	Sur.	Prix HT
L . 16 13 425	38	7,2 x 19	24	2,25



Verres à pied

Riviera bleu

Laver à la main uniquement



A.



B.



C.



D.



Code	Ccl	Φ x Ht cm	Sur.	Prix HT
------	-----	-----------	------	---------

Boîte de 4 verres

E . 16 05 446	49	9,5 x 20,2	4	12,60
F . 16 05 447	36,5	10,5 x 16,2	4	13,25

Code	Ccl	Φ x Ht cm	Sur.	Prix HT
------	-----	-----------	------	---------

Boîte de 4 verres

G . 16 05 445	24	7 x 24	6	12,60
H . 16 05 448	52,5	9 x 10,5	6	9,15



Riviera vert

Laver à la main uniquement



E.



F.



G.



H.

Code	Ccl	Φ x Ht cm	Sur.	Prix HT
------	-----	-----------	------	---------

Boîte de 4 verres

E . 16 05 436	49	9,5 x 20,2	4	12,60
F . 16 05 437	36,5	10,5 x 16,2	4	13,25

Code	Ccl	Φ x Ht cm	Sur.	Prix HT
------	-----	-----------	------	---------

Boîte de 4 verres

G . 16 05 435	24	7 x 24	6	12,60
H . 16 05 438	52,5	9 x 10,5	6	9,15

Riviera Orange

Laver à la main uniquement



I.



J.



K.



L.



Code	Ccl	Φ x Ht cm	Sur.	Prix HT
------	-----	-----------	------	---------

Boîte de 4 verres

I . 16 05 441	49	9,5 x 20,2	4	12,60
J . 16 05 442	36,5	10,5 x 16,2	4	13,25

Code	Ccl	Φ x Ht cm	Sur.	Prix HT
------	-----	-----------	------	---------

Boîte de 4 verres

K . 16 05 440	24	7 x 24	6	12,60
L . 16 05 443	52,5	9 x 10,5	6	9,15



Eden

Laver à la main uniquement



A.



B.



C.



D.

Code	Ccl	Φ x Ht cm	Sur.	Prix HT
------	-----	-----------	------	---------

Boîte de 4 verres

A . 16 05 462	48	11,6 x 24	4	22,50
B . 16 05 461	36	10,5 x 22,5	4	21,90

Code	Ccl	Φ x Ht cm	Sur.	Prix HT
------	-----	-----------	------	---------

Boîte de 4 verres

C . 16 05 460	17	7,5 x 26	4	20,60
D . 16 05 463	35,5	9,8 x 11	4	16,90

Gatsby

Laver à la main uniquement



E.



F.



G.

Code	Ccl	Φ x Ht cm	Sur.	Prix HT
------	-----	-----------	------	---------

Boîte de 4 verres

E . 16 05 450	57	9,5 x 25,4	4	17,20
F . 16 05 451	31	11 x 18,4	4	17,20

Code	Ccl	Φ x Ht cm	Sur.	Prix HT
------	-----	-----------	------	---------

Boîte de 4 verres

G . 16 05 452	59	9,5 x 12	4	14,40
---------------	----	----------	---	-------



Léopard

Laver à la main uniquement



H.



I.



J.



K.

Code	Ccl	Φ x Ht cm	Sur.	Prix HT
------	-----	-----------	------	---------

Boîte de 4 verres

H . 16 05 457	43	9 x 22	4	18,10
I . 16 05 456	27	11,5 x 18,5	4	19,40

Code	Ccl	Φ x Ht cm	Sur.	Prix HT
------	-----	-----------	------	---------

Boîte de 4 verres

J . 16 05 455	18	7 x 26,3	4	16,25
K . 16 05 458	52	9,5 x 12	4	13,70

Roma

Calice résistant pour des usages intensifs. Verre mécanique.



A.



B.



C.



D.

Code	Ccl	Φ x Ht cm	Sur.	Prix HT
A . 75 42 344	34	8,1 x 18,4	6	2,20
B . 75 42 345	24	7,5 x 17	6	2,12

Code	Ccl	Φ x Ht cm	Sur.	Prix HT
C . 75 42 346	20	6,9 x 15,4	6	2,12
D . 75 42 347	19	6,3 x 19,8	6	2,28



L'esprit du vin

Verre non trempé.



E.
Eau



F.
Flûte



G.
FB

Code	Ccl	Φ x Ht cm	Sur.	Prix HT
E . 75 42 072	32	7,7 x 19,8	6	3,19
E . 75 42 073	25	7,1 x 19	6	2,98
F . 75 42 074	21	6,3 x 21,4	6	3,06
G . 75 42 075	33	8,5 x 9,9	6	2,92

Perfection

Verre Xtratuff pied plaqué.



H.



I.

Code	Ccl	Φ x Ht cm	Sur.	Prix HT
H . 75 42 055	n°1-41	8,6 x 20,8	12	4,69
I . 75 42 056	n°0-32	7,9 x 19,8	12	4,55

Aristo carré

Verre non trempé.



J.
Rouge



K.
Blanc



L.
Flûte

Code	Ccl	Φ x Ht cm	Sur.	Prix HT
J . 75 42 120	38	8,3 x 21,7	6	3,54
K . 75 42 121	29	7,6 x 20,7	6	3,54
L . 75 42 122	22	6,9 x 22,8	6	3,54



SPKSY

Le goût de la prohibition réinventée.



M . Gin & T



N . Martini

Code	Ccl	Φ x Ht cm	Sur.	Prix HT
M . 75 42 036	58	10,3 x 20,3	12	5,31
N . 75 42 038	19,3	9,9 x 16,4	12	5,85



O . Nick & Nora



P . Calice

Code	Ccl	Φ x Ht cm	Sur.	Prix HT
O . 75 42 032	24,5	7,9 x 16	12	5,31
P . 75 42 037	24,5	9,65 x 15,23	12	5,31

Anchor

XTRATUFF

Verre Xtratuff «Double old fashioned»
Parfait pour les shortdrinks et spiritueux en glace.



A . FH



B . FB

Code	Ccl	Φ x Ht cm	Sur.	Prix HT
A . 75 42 271	47	8,5 x 15,7	12	5,46
B . 75 42 270	35,5	8,8 x 10,5	12	4,99

Pentagon

XTRATUFF

Cinq facettes à la base, buvant arrondi.
Verre Xtratuff.



C . FH



D . FB

Code	Ccl	Φ x Ht cm	Sur.	Prix HT
C . 75 42 184	35	8,1 x 14,3	12	3,96
C . 75 42 185	29	7,7 x 13,8	12	3,34
D . 75 42 187	35	9,6 x 10	12	3,64
D . 75 42 189	26	8,6 x 9	12	3,56

ICON

oris

Résistants et solides.



E . FH



F . FB



G .

Code	Ccl	Φ x Ht cm	Sur.	Prix HT
E . 75 42 241	47	8,4 x 15,7	12	5,63
F . 75 42 242	35	8,9 x 10,7	12	5,03
G . 75 42 240	6	5 x 6,1	24	3,86

Adventure

XTRATUFF

Parfaitement empilable pour
mettre en pyramide.



H . FB



H . FB

Code	Ccl	Φ x Ht cm	Sur.	Prix HT
H . 75 42 171	35	9,8 x 10,5	12	2,52
H . 75 42 172	26	8,9 x 9,8	12	2,07
H . 75 42 173	20	8,3 x 9,2	12	2,20

Facets

XTRATUFF

Verre à xxx solides



I . FH



J . FB

Code	Ccl	Φ x Ht cm	U.V	Prix HT
I . 75 42 201	47	8,4 x 15,3	36	2,75
I . 75 42 202	35	7,9 x 13,7	36	2,50
J . 75 42 203	26	7,5 x 10,3	36	2,33

Hampshire

XTRATUFF

Retour des produits d'antan baroques.
Verre Xtratuff



K .



L .

Code	Ccl	Φ x Ht cm	Sur.	Prix HT
K . 75 42 209	37	7,7 x 13,6	12	2,92
L . 75 42 204	29	8,32 x 9	36	2,51
L . 75 42 205	23	7,9 x 8,5	36	2,34



M . FH



M . FH



Code	Ccl	Φ x Ht cm	Sur.	Prix HT
M . 75 42 168	47	8,3 x 17,8	12	3,32
M . 75 42 169	35	7,6 x 15,9	12	3,17
M . 75 42 170	29	7 x 15,9	12	3,06



Targ

XTRATUFF

Sophisticé, raffiné, empilable.



N . FH



O . FB

Code	Ccl	Φ x Ht cm	Sur.	Prix HT
N . 75 42 296	34,5	7,9 x 12,7	12	2,46
O . 75 42 297	35	8,8 x 9,7	12	2,46
O . 75 42 298	26	8,1 x 8,7	12	2,46

Cognac - Spirits



A . XXL



B . Mondial



C . Snifter



D . Réverie



E . Mixology



F . Joy

Code	Ccl	Φ x Ht cm	Sur.	Prix HT
------	-----	-----------	------	---------

A . 75 43 055	88	11,2 x 16,3	6	6,25
B . 75 43 344	51,1	10,1 x 14,7	6	3,58

Code	Ccl	Φ x Ht cm	Sur.	Prix HT
------	-----	-----------	------	---------

C . 75 34 491	53	9,9 x 14,9	24	3,73
D . 16 13 430	39	9 x 12,5	24	1,55

Code	Ccl	Φ x Ht cm	Sur.	Prix HT
------	-----	-----------	------	---------

E . 75 36 255	46	9,7 x 12,7	12	5,72
				Boîte de 4 verres
F . 16 13 379	26	8,5 x 12,9	6	11,95



G . Arc



H . Arc



I . Arc



J . Open Up



K . Rhum



L . Warm

Code	Ccl	Φ x Ht cm	Sur.	Prix HT
------	-----	-----------	------	---------

G . 75 11 002	41	9,5 x 12,9	24	4,38
H . 75 11 003	25	8,2 x 11,2	24	3,51

Code	Ccl	Φ x Ht cm	Sur.	Prix HT
------	-----	-----------	------	---------

I . 75 11 005	15	6,7 x 9,6	72	3,12
J . 75 06 420	38	9,3 x 9,4	24	3,27

Code	Ccl	Φ x Ht cm	Sur.	Prix HT
------	-----	-----------	------	---------

K . 75 11 500	17	7,5 x 12,7	24	4,04
L . 75 06 423	29	9,9 x 8,6	24	5,97

Irish coffee



M . Sentido



N .



O . Nick & Nora
Rocco



P . Nick & Nora
Mixology



Q . Nick & Nora
Timeless



R . Pied vert
(lot de 3)

Code	Ccl	Φ x Ht cm	Sur.	Prix HT
------	-----	-----------	------	---------

M . 16 31 115	26	11,1 x 14,2	6	3,46
N . 75 10 550	24	7,6 x 13,9	24	5,52

Code	Ccl	Φ x Ht cm	Sur.	Prix HT
------	-----	-----------	------	---------

O . 75 34 107	15,5	7,4 x 15,5	24	3,70
P . 75 36 247	15	6,9 x 14,7	24	3,59

Code	Ccl	Φ x Ht cm	Sur.	Prix HT
------	-----	-----------	------	---------

				Boîte de 4 verres
Q . 16 13 224	16	8 x 13,5	6	3,97
				Lot de 3 verres
R . 19 71 890	16,5	6,5 x 16	6	10,50

Bière chopes



S . Brasseur
(lot de 3)



T . Weizen
(Pièce)



U . Belek
(Pièce)



V . Bière
(lot de 2)



W . Martigues



X . Martigues

Code	Ccl	Φ x Ht cm	Sur.	Prix HT
------	-----	-----------	------	---------

				Lot de 3 verres
S . 16 11 480	40	6,9 x 19,9	6	5,79
				Pièce
T . 75 41 132	69	8 x 23,3	12	2,47

Code	Ccl	Φ x Ht cm	Sur.	Prix HT
------	-----	-----------	------	---------

				Pièce
U . 16 18 396	58	8 x 16	12	1,85
				Lot de 2 verres
V . 16 18 397	33	7 x 16,5	12	3,45

Code	Ccl	Φ x Ht cm	Sur.	Prix HT
------	-----	-----------	------	---------

W . 75 06 310	16	6,9 x 15	24	2,15
X . 75 06 017	33	8 x 17,9	6	2,56

Wells



A



B

Code	Ccl	Φ x Ht cm	Sur.	Prix HT
A . 75 11 228	28	7 x 16	24	3,54
B . 75 11 229	38	7,5 x 17	24	3,75
B . 75 11 230	42,5	7,5 x 18	24	4,20
B . 75 11 231	57	8,5 x 19	24	4,20



Joly



C



D

Code	Ccl	Φ x Ht cm	Sur.	Prix HT
C . 75 12 153	35	9,2 x 12,5	24	4,01
D . 75 12 154	45	9,7 x 13,8	24	4,69



E . Hurricane



F . Fiesta



G . Essence



H . Cerveoise



I . Cerveoise

Code	Ccl	Φ x Ht cm	Sur.	Prix HT
E . 75 10 059	44	7,9 x 20,7	24	6,59
F . 16 18 319	46	8 x 19,5	12	2,19
G . 16 13 060	40,5	8 x 18	6	1,83

Code	Ccl	Φ x Ht cm	Sur.	Prix HT
H . 75 10 620	32	7,2 x 16,8	24	3,54
I . 75 08 027	38	7,6 x 17,8	24	3,75
I . 75 10 621	50	8,3 x 19,2	24	4,20



J . Capri



K . Tulip

Code	Ccl	Φ x Ht cm	Sur.	Prix HT
J . 75 41 120	38,5	7,3 x 17,6	24	2,45
K . 16 13 425	38	7 x 19	24	2,25



L . Draft



M . Linz

Code	Ccl	Φ x Ht cm	Sur.	Prix HT
L . 75 41 942	38	7,1 x 18,8	24	2,13
M . 75 06 134	39	6,9 x 20,6	24	3,01



N . Bartender



O . Bartender

Code	Ccl	Φ x Ht cm	Sur.	Prix HT
N . 75 34 665	52	8,1 x 23,9	18	5,41
O . 75 34 664	40,5	7,5 x 22,4	24	4,42
O . 75 34 663	28	6,6 x 20,6	24	4,01

Bocks



P . Britannia



Q . Basic

Code	Ccl	Φ x Ht cm	Sur.	Prix HT
P . 75 08 008	28	8,2 x 9,6	36	2,81
P . 75 08 009	56	9,9 x 12,4	24	3,51
Q . 75 41 105	35	12,5 x 9,8	24	2,36



R . Latino



S . Chope

Code	Ccl	Φ x Ht cm	Sur.	Prix HT
R . 75 08 100	29	9,9 x 15	24	4,17
S . 75 41 055	50	8,5 x 13,6	24	3,40
S . 75 41 056	39,5	7,7 x 13,5	12	3,11



T . Brasseur (lot de 2)



U . Haworth

Code	Ccl	Φ x Ht cm	Sur.	Prix HT
T . 16 05 383	54	10 x 12,5	6	4,03
U . 75 08 010	57	9,3 x 13,1	24	3,51
U . 75 08 011	28	7,1 x 10,3	36	2,81

Coupe - Cocktail

Calices

ARCOROC



A . Disco



B . Disco



C . Elégance



D . Symétrie



E . Coupe
Champagne Cabernet



F . Speakeasy
Swing



G . Meravigliosi

Code	Ccl	Φ x Ht cm	Sur.	Prix HT
A . 75 11 347	21	9 x 16	24	3,77
B . 75 11 346	18	7,5 x 17	12	3,77
C . 75 11 270	16	9 x 12,2	48	3,21

Code	Ccl	Φ x Ht cm	Sur.	Prix HT
D . 75 11 294	21	11,4 x 18	24	5,54
E . 75 10 437	30	12 x 16,5	12	5,04

Code	Ccl	Φ x Ht cm	Sur.	Prix HT
F . 75 36 564	30	10,7 x 14,8	24	7,98
G . 75 36 556	30	10,7 x 14,8	24	4,99



H . Michelangelo



I . Mixology



J . Cocktail Roma



K . Fizz



L . Novecento
Cocktail



M . America

Code	Ccl	Φ x Ht cm	Sur.	Prix HT
H . 75 36 015	22	9,5 x 14	24	4,20
I . 75 36 249	22,5	9,5 x 14	24	4,39

Code	Ccl	Φ x Ht cm	Sur.	Prix HT
J . 75 36 257	30	11,3 x 15	12	6,00
K . 75 36 477	26	9,7 x 15,7	16	5,42

Code	Ccl	Φ x Ht cm	Sur.	Prix HT
L . 75 34 437	25	9,4 x 15,5	24	4,55
M . 75 34 287	23	9,8 x 14,7	24	5,18



Margarita



N . Joy



O . Coupe



P . Coupe



Q . Margarita
Roma



R . Margarita
Capri 30



S . Margarita
non trempé

Code	Ccl	Φ x Ht cm	Sur.	Prix HT
Boîte de 4 verres				
N . 16 13 381	25	12,1 x 14,7	2	14,40
O . 16 13 186	27	10,8 x 15,7	12	16,61
P . 16 13 085	26	10,1 x 16,4	12	16,80

Code	Ccl	Φ x Ht cm	Sur.	Prix HT
Q . 75 36 261	39	11,4 x 18,4	12	6,23

Code	Ccl	Φ x Ht cm	Sur.	Prix HT
R . 75 41 948	30,5	11,5 x 16,9	12	2,24
S . 75 10 074	27	10,8 x 16	24	6,58

Martini cocktail

Brio

ARCOROC



A . Cabernet cocktail



B . New Martini



C . Brio



D . Brio



E . Brio

Code	Ccl	Φ x Ht cm	Sur.	Prix HT
A . 75 10 413	30	12 x 18,8	12	5,04
A . 75 10 346	30	11,6 x 17,2	12	5,04
B . 75 10 347	21	11,4 x 17,9	24	5,04

Code	Ccl	Φ x Ht cm	Sur.	Prix HT
C . 75 10 902	21	8,3 x 19,2	12	3,35
D . 75 10 901	16	6,9 x 22,4	24	3,35
E . 75 10 900	9,5	5,6 x 17,1	24	2,97



F . Martini Mixology



G . Roma Martini



H . Bach



I . Ypsilon



J . America 20s



K . Martini Chiller

Code	Ccl	Φ x Ht cm	Sur.	Prix HT
G . 75 36 248	21,5	10,4 x 17,2	24	5,38
H . 75 36 260	22	10,4 x 17,2	24	5,62

Code	Ccl	Φ x Ht cm	Sur.	Prix HT
K . 75 34 084	24,5	11,2 x 18,2	6	7,14
J . 75 36 473	26	11,3 x 18,5	16	6,56

Code	Ccl	Φ x Ht cm	Sur.	Prix HT
N . 75 34 289	25	10,8 x 18	12	6,03
I . 75 42 050	17	11,1 x 8,9	6	7,53



L . Martini Estrella



M . Martini



O . Joy



P . Martini Elysia



Q . Martini Timeless

Code	Ccl	Φ x Ht cm	Sur.	Prix HT
L . 75 41 554	21	11,6 x 17,2	4	3,51
M . 75 41 859	19	10,7 x 13,6	12	1,75

Code	Ccl	Φ x Ht cm	Sur.	Prix HT
O . 16 13 382	22	11,8 x 16	2	15,40

Code	Ccl	Φ x Ht cm	Sur.	Prix HT
P . 16 13 083	22	11,6 x 17,2	6	18,34
Q . 16 13 191	23	11,6 x 17,2	12	17,54

Flûtes point mousse



A . Tre sensi



B . Dream



C . Michelangelo



D . Allegra



E . Ivory



F . Florian



G . Celebrazion

Code	Ccl	Φ x Ht cm	Sur.	Prix HT
A . 75 34 430	15	6,8 x 18,5	6	3,36
A . 75 34 433	21,5	5,9 x 20	24	4,14
B . 75 36 105	14	6 x 19,1	24	3,40

Code	Ccl	Φ x Ht cm	Sur.	Prix HT
C . 75 36 014	16	6,4 x 18,5	24	3,94
D . 75 41 619	19,5	7 x 22,6	6	2,53
E . 16 18 597	22,5	6,9 x 22,6	12	5,04

Code	Ccl	Φ x Ht cm	Sur.	Prix HT
F . 75 34 645	21	6,5 x 22	24	4,07
G . 75 34 672	21	7,5 x 22,1	12	3,70

Boîte de 3 verres

Solides



H . Tulip



I . Florence
(lot de 3)



J . Noa
(lot de 3)



K . Timeless
(Boîte de 4)



L . Esprit



M . Essence



N . Silhouette



O . West Loop

Code	Ccl	Φ x Ht cm	Sur.	Prix HT
H . 75 41 285	20	6,5 x 20,5	24	1,50
I . 16 18 377	23	6,2 x 22,7	18	5,50

Code	Ccl	Φ x Ht cm	Sur.	Prix HT
J . 16 18 834	17,5	6 x 22,5	8	5,92
K . 16 13 188	17,5	6,4 x 22,5	4	13,40
L . 75 42 074	21	6,3 x 21,4	6	3,06

Code	Ccl	Φ x Ht cm	Sur.	Prix HT
M . 16 13 064	19	6,5 x 22,5	6	1,35
N . 75 11 329	18	6,4 x 18,1	24	2,98
O . 75 10 814	14	5,3 x 20,5	12	4,55



P . Vina



Q . Elisa



R . Princesa



S . Equip home



T . Normandie



U . Reims



V . Savoie



W . Elégance

Code	Ccl	Φ x Ht cm	Sur.	Prix HT
P . 75 10 034	19	5,5 x 22,5	24	2,97
Q . 75 10 617	17	5,3 x 19,2	48	3,28
R . 75 10 610	15	5,4 x 19,5	24	3,01

Code	Ccl	Φ x Ht cm	Sur.	Prix HT
S . 75 10 831	17	6 x 17,5	24	2,05
T . 75 10 504	14	5,2 x 17,3	48	3,33
U . 75 10 892	14	6 x 15,6	12	1,35

Code	Ccl	Φ x Ht cm	Sur.	Prix HT
V . 75 10 040	17	6,1 x 17	48	2,24
W . 75 11 269	17	5,5 x 17,5	48	2,38
W . 75 11 267	13	4,7 x 17,9	48	2,76
W . 75 11 266	10	4,7 x 15,9	48	2,50

Flûtes cocktails



A . Michelangelo

B . Supremo

C . Roma

D . Bach

E . Néo

F . Oslo

G . Zénith

Code	Ccl	Φ x Ht cm	Sur.	Prix HT
A . 75 36 014	16	6,4 x 18,5	24	3,94
B . 75 36 461	24	6,4 x 25	24	5,15

Code	Ccl	Φ x Ht cm	Sur.	Prix HT
C . 75 36 264	24	7 x 24,4	24	4,96
D . 75 36 469	21	5,3 x 23,5	24	5,47

Code	Ccl	Φ x Ht cm	Sur.	Prix HT
Boîte de 6 verres				
E . 79 35 048	20	6,8 x 22	4	14,30
F . 79 35 028	20	4,9 x 21	8	12,80
G . 79 35 018	19	6 x 21,7	4	19,50

Cristallin



H . Sublym

I . Open up

J . Cabernet

K . Cabernet

L . Séquence impérial

M . Sensation Exalt

Code	Ccl	Φ x Ht cm	Sur.	Prix HT
H . 75 10 914	21	7 x 24	24	4,42
I . 75 10 926	20	7,4 x 23,4	24	6,29
J . 75 10 411	16	7 x 22,5	24	3,60

Code	Ccl	Φ x Ht cm	Sur.	Prix HT
K . 75 10 410	24	6,2 x 23,5	24	4,00
L . 75 11 188	24	7 x 23,5	24	4,00
M . 75 10 673	19	7 x 21	24	3,62



N . Exaltation

O . Évidence

P . Symétrie

Q . Symétrie

R . Distinction

S . V.Juliette

T . Séquence

Code	Ccl	Φ x Ht cm	Sur.	Prix HT
N . 75 10 826	35	8,1 x 23,5	6	4,59
N . 75 10 825	30	7,8 x 21,1	6	4,23
O . 75 11 318	16	6,2 x 19	24	3,44

Code	Ccl	Φ x Ht cm	Sur.	Prix HT
P . 75 11 296	21	6,5 x 24	24	4,88
Q . 75 11 283	23	7 x 23,3	24	4,01
R . 75 11 295	16	6,5 x 19,8	24	4,23

Code	Ccl	Φ x Ht cm	Sur.	Prix HT
S . 75 10 358	22	6,5 x 21,7	24	3,28
T . 75 10 865	17	5,6 x 20,8	24	4,00

Tiki

Cocktail tropical style hawaïen.

oris



A . Bamboo Tiki B . Tiki Splits C . The Glitch Tiki

Code	Ccl	Φ x Ht cm	Sur.	Prix HT
A . 75 42 286	46,5	6,8 x 17,2	6	4,18
B . 75 42 285	47	9,6 x 11,4	6	3,86
C . 75 42 258	40	6,5 x 15	6	4,56



Tiki

Verre transparent non trempé.



D . Pineapple E . Chope

Code	Ccl	Φ x Ht cm	Sur.	Prix HT
D . 75 42 284	53	8 x 14	12	6,93
E . 75 34 856	58	8,8 x 16,5	6	3,80



F . Pulcinella (lot de 4) G . Venezia (lot de 4)

Code	Ccl	Φ x Ht cm	Sur.	Prix HT
<u>Boîte de 4 verres</u>				
F . 19 46 032	45	7,6 x 13,6	2	34,44
G . 19 46 033	45	7,6 x 13,6	2	34,44



H . Sardinia (lot de 4) I . Etruria (lot de 4)

Code	Ccl	Φ x Ht cm	Sur.	Prix HT
<u>Boîte de 4 verres</u>				
H . 19 46 025	46	7,6 x 13,6	2	34,44
I . 19 46 026	45	7,6 x 13,6	2	34,44



J . Fontaine K . Mug

Code	Ccl	Φ x Ht cm	Sur.	Prix HT
J . 16 05 028	400	16,4 x 26	4	7,50
J . 16 05 029	800	19,5 x 31,5	4	13,50
K . 16 05 080	45	6,5 x 14	12	1,75
L . 75 31 015	41,5	9,3 x 13,6	12	3,65

novastyl

L . Bocal anse



Bartender Mules

Sweet et Sour sont accompagnés par les 3 mules en verre.



M . Sour N . Sweet O . Moscow P . Mojito Q . Julep

Code	Ccl	Φ x Ht cm	Sur.	Prix HT
M . 75 34 854	45,5	8,5 x 11,7	6	3,61
N . 75 34 855	44	8,5 x 11,7	6	3,61
O . 75 34 851	54	8,7 x 10,6	6	3,47

Code	Ccl	Φ x Ht cm	Sur.	Prix HT
P . 75 34 853	38	8,7 x 11,8	6	2,85
Q . 75 34 852	36,5	8,7 x 11,5	6	2,85

Serenity

Trempe et parfaitement empilables.



A . FH



B . FH



C . FB



D . FB

Code	Ccl	Φ x Ht cm	Sur.	Prix HT
------	-----	-----------	------	---------

Lot de 3 verres

A . 16 13 114	35,5	8,5 x 12,5	8	4,45
B . 16 13 113	26,5	7,5 x 12	16	4,21

Code	Ccl	Φ x Ht cm	Sur.	Prix HT
------	-----	-----------	------	---------

Lot de 3 verres

C . 16 13 112	25,5	8,2 x 9	8	4,14
D . 16 13 111	21	8 x 8,5	8	4,04
D . 16 13 110	6	4,5 x 5,5	12	5,98



Next

Verre trempé empilable



E . FH



F . FB

Code	Ccl	Φ x Ht cm	Sur.	Prix HT
------	-----	-----------	------	---------

E . 75 41 162	28	7,3 x 11,8	12	1,32
F . 75 41 161	20	7,1 x 9,6	12	0,92
F . 75 41 160	16	6,6 x 7,9	12	0,92



novastyl



G . Chope Mojito non trempé

Code	Ccl	Φ x Ht cm	Sur.	Prix HT
------	-----	-----------	------	---------

G . 16 13 140	36,5	8 x 12	24	1,61
---------------	------	--------	----	------

Casablanca

Verre trempé.



H . FH



H . FH



I . FB



I . FB



J . FB

Code	Ccl	Φ x Ht cm	Sur.	Prix HT
------	-----	-----------	------	---------

H . 75 41 198	47,5	8,6 x 16,2	24	2,07
H . 75 41 196	36,5	8 x 14,8	48	1,50
H . 75 41 197	35,5	8 x 12	48	1,38
H . 75 41 192	28	7,8 x 12	48	1,21

Code	Ccl	Φ x Ht cm	Sur.	Prix HT
------	-----	-----------	------	---------

I . 75 41 194	35,5	9,2 x 10	24	1,55
I . 75 41 193	27	8,6 x 9,2	36	1,27
I . 75 41 195	20	7,5 x 8	24	1,09
J . 75 41 191	3,6	4,8 x 5,5	144	0,75

Chicago

Verre non trempé.

novastyl



K . FH



K . FH

Code	Ccl	Φ x Ht cm	Sur.	Prix HT
------	-----	-----------	------	---------

Boîte de 6 verres				
K . 16 18 083	4,5	4,9 x 5,6	4	4,50
Boîte de 3 verres				
K . 16 18 610	20	7,9 x 8,2	8	2,99
K . 16 18 611	30	8,7 x 9,5	8	4,01
K . 16 18 612	30	8 x 12,2	8	4,01



Novecento

Verres empilables non trempé au look vintage.



Code	Ccl	Φ x Ht cm	Sur.	Prix HT
A . 75 34 501	40,5	8 x 13,5	24	3,47
B . 75 34 500	37	8,7 x 10,1	24	3,47
C . 75 34 502	7,7	5,5 x 7,9	24	2,30

Oxford bar

Verre trempé conique et parfaitement empilable.

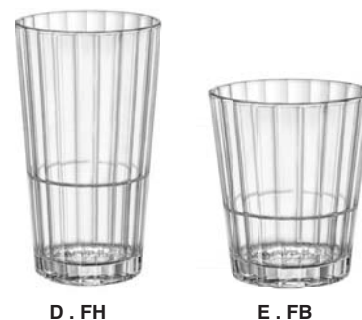

Code	Ccl	Φ x Ht cm	Sur.	Prix HT
D . 75 34 163	39,5	8,2 x 14,3	24	3,22
E . 75 34 162	37,4	8,9 x 10,4	24	2,76
E . 75 34 161	31,2	8,5 x 9,9	24	2,51

Este

Des lignes droites entrelacées avec des motifs géométriques créant l'équilibre et l'harmonie.

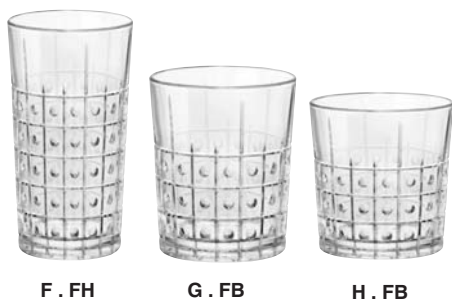

Code	Ccl	Φ x Ht cm	Sur.	Prix HT
F . 75 34 862	29	7,2 x 14	24	3,22
G . 75 34 861	37	9 x 10,7	24	3,54
H . 75 34 860	30	8,5 x 9	24	3,20

Lounge

Un motif de coupe aux lignes sophistiqués : idéal pour donner des effets lumineux



Code	Ccl	Φ x Ht cm	Sur.	Prix HT
I . 75 34 864	39	8,9 x 10,7	24	3,46
I . 75 34 863	27,5	8,2 x 8,8	24	3,66

Stone

Une représentation pierre précieuse vintage.



Code	Ccl	Φ x Ht cm	Sur.	Prix HT
J . 75 34 865	49	8,4 x 15,8	12	3,89

Ypsilon

Verre mécanique, conique avec fond lourd.



Code	Ccl	Φ x Ht cm	Sur.	Prix HT
K . 75 34 085	32	7,7 x 16	12	3,27
L . 75 34 086	34	10,1 x 11,7	24	3,77

Code	Ccl	Φ x Ht cm	Sur.	Prix HT
M . 75 34 087	25	9,2 x 10,7	24	2,62
N . 75 34 088	15	7,7 x 9,5	24	2,55



Starline

Tendance Art Déco. Verre trempé.
Compatible gravity



Code	Ccl	Φ x Ht cm	Sur.	Prix HT
A . 75 07 515	65	9,5 x 18	12	3,89
B . 75 07 514	46	8,5 x 16	12	3,09
C . 75 07 513	31	7,5 x 14	24	2,20
Code	Ccl	Φ x Ht cm	Sur.	Prix HT
D . 75 07 512	42	9 x 13	24	2,20
E . 75 07 511	35	8,5 x 12	48	2,20
F . 75 07 510	27	8,5 x 10	36	1,79

Stack up

Verre trempé conique empilable.



Stack up Cross

Tendance Art Déco. Verre trempé.



Code	Ccl	Φ x Ht cm	Sur.	Prix HT
G . 75 07 245	47	8,7 x 14,7	24	2,45
G . 75 07 244	40	8,3 x 14,4	24	2,20
G . 75 07 241	35	7,8 x 14	24	2,20
G . 75 07 240	29	7,6 x 11,9	24	2,20
Code	Ccl	Φ x Ht cm	Sur.	Prix HT
H . 75 07 239	4,5	5 x 6	48	1,35
I . 75 07 246	26	7,5 x 9,2	24	1,79
I . 75 07 243	32	9,2 x 9,2	24	1,98
I . 75 07 242	21	8,3 x 8	24	1,79



Code	Ccl	Φ x Ht cm	Sur.	Prix HT
J . 75 07 462	35	7,8 x 14	24	2,31
K . 75 07 461	26	8,5 x 9,2	24	1,89
K . 75 07 460	21	8,3 x 8	24	1,89

Shetland

Verre non trempé Arcoroc.



Code	Ccl	Φ x Ht cm	Sur.	Prix HT
H . 75 06 074	42	8,8 x 14,6	48	2,44
H . 75 06 073	35	8,3 x 13,8	48	1,98
I . 75 06 072	22	7,2 x 12,2	48	1,77
Code	Ccl	Φ x Ht cm	Sur.	Prix HT
J . 75 06 069	15	7 x 9	48	1,81
J . 75 06 068	9	6 x 7,3	48	1,51
K . 75 06 071	32	9,7 x 9,6	48	2,02
K . 75 06 070	25	9 x 8,8	48	1,77

Brixton



Perception fond lourd avec un design géométrique.



Code	Ccl	Φ x Ht cm	Sur.	Prix HT
D . 75 07 290	30	8,6 x 9,6	12	3,09



Gobelets et chopes trempé

New York

Verre trempé et empilable, inspiré de la tendance vintage, un trait distinctif commun sur tous les gobelets : un renflement au tiers du gobelet souligne la déclinaison des moules.

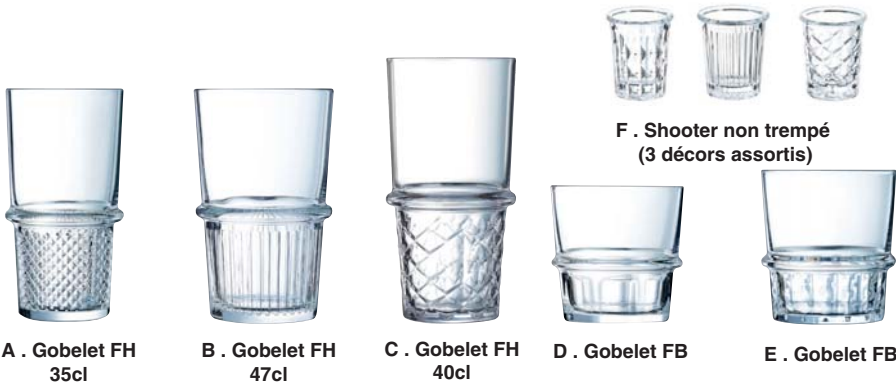

A . Gobelet FH
35cl

B . Gobelet FH
47cl

C . Gobelet FH
40cl

D . Gobelet FB

E . Gobelet FB

F . Shooter non trempé
(3 décors assortis)

Code	Ccl	Φ x Ht cm	Sur.	Prix HT
A . 75 07 343	35	7,4 x 14,4	24	2,81
B . 75 07 344	47	8,7 x 14,4	24	3,07
C . 75 07 342	40	7,7 x 15,5	24	2,97

Code	Ccl	Φ x Ht cm	Sur.	Prix HT
D . 75 07 340	25	8,1 x 8,4	24	2,24
E . 75 07 341	38	8,9 x 10	24	2,78
F . 75 07 338	3,4	4,4 x 5,5	24	1,23



Arcadie

Verre trempé. Un design relancé.

ARCOROC



G . FH 40 cl

H . FH 35 cl

I . FH 24 cl

J . FH 16 cl

K . FH 9 cl

Code	Ccl	Φ x Ht cm	Sur.	Prix HT
G . 75 07 454	40	9,3 x 12,6	24	2,76
H . 75 07 453	35	9,6 x 9,8	24	2,38
I . 75 07 452	24	8,5 x 8,6	24	1,53

Code	Ccl	Φ x Ht cm	Sur.	Prix HT
J . 75 07 451	16	7,3 x 7,3	24	1,50
K . 75 07 450	9	6,2 x 6,3	24	1,35



Log

Ergonomiques et empilables.



L . FB

Code	Ccl	Φ x Ht cm	Sur.	Prix HT
L . 75 07 331	16	6,3 x 8	48	1,44
L . 75 07 332	27	7,6 x 9,3	48	1,53
L . 75 07 330	22	7,3 x 7,9	48	1,44

Eskale

Inspirée du design des pots à confiture.



A . Gobelet FH

B . Gobelet FH



C . Gobelet FH

Code	Ccl	Φ x Ht cm	Sur.	Prix HT
A . 75 15 288	9	6,2 x 6,4	24	1,75
B . 75 15 287	18	7,7 x 7,8	24	1,91
C . 75 15 286	31	9 x 8,7	24	2,36

Granity

Verre trempé



D . FH



E . FH



F . FB 35cl



F . FB 4.5 cl

Code	Ccl	Φ x Ht cm	Sur.	Prix HT
D . 75 07 082	65	9,6 x 17,8	12	3,45
D . 75 07 083	46	8,7 x 16	24	2,39
D . 75 07 084	42	8,9 x 13	24	2,14
D . 75 07 085	35	8,5 x 12,1	6	2,14
E . 75 07 087	31	7,5 x 14	6	2,14
E . 75 07 088	20,4	6,4 x 12,7	24	1,75

Code	Ccl	Φ x Ht cm	Sur.	Prix HT
F . 75 07 079	35	9,3 x 10,7	24	1,91
F . 75 07 092	27	8,5 x 9,8	6	1,75
F . 75 07 094	20	8 x 8,1	24	1,75
F . 75 07 089	16	7,3 x 7,3	48	1,50
F . 75 07 093	4,5	5 x 5,7	48	1,31

Norvège

Verre trempé empilable



G . FH



H . FB

Code	Ccl	Φ x Ht cm	Sur.	Prix HT
G . 75 07 479	27	7,2 x 11,3	24	1,63
H . 75 07 478	25	7,5 x 9,4	24	1,44
H . 75 07 477	20	7,1 x 8,8	24	1,17
H . 75 07 476	16	6,5 x 8,2	24	1,17



Nonic

Verre trempé empilable



I . FH



J . FB

Code	Ccl	Φ x Ht cm	Sur.	Prix HT
I . 75 07 077	57	8,6 x 15,1	48	2,05
J . 75 07 076	34	7,6 x 12,7	48	1,62
J . 75 07 075	28	7,3 x 11,4	48	1,58

Campus

Verre trempé empilable



K . FH



L . FB

Code	Ccl	Φ x Ht cm	Sur.	Prix HT
K . 75 07 022	29	6,6 x 12,8	48	1,46
L . 75 07 021	22	6,5 x 9,7	48	1,44
L . 75 07 020	18	5,6 x 8,5	48	1,44



Élisa - Oxygène - Forum

Verre trempé



M . Elisa



N . Oxygène



O . Forum

Code	Ccl	Φ x Ht cm	Sur.	Prix HT
M . 75 07 147	23	7,3 x 8,2	24	1,61
N . 75 07 152	16	6,8 x 8,1	72	1,17
O . 75 07 484	23	7,7 x 8,1	48	1,44
O . 75 07 483	16	6,9 x 7,2	48	1,17



Picardie

Verre trempé. Le Picardie 22cl est désormais toléré à 20cl.



A . Transparent

B . Transparent

C . Marine 25cl
(Teintés dans la masse)

D . Gris 25cl

E . Picardie 25cl
(Teintés dans la masse)

Code	Ccl	Φ x Ht cm	Sur.	Prix HT
A . 75 25 068	50	9,4 x 14,5	24	2,64
A . 75 25 073	36	8,8 x 12,4	48	2,04
A . 75 25 074	31	9 x 9,4	48	1,80
B . 75 25 064	25	8,7 x 9	72	1,52
B . 75 25 063	20	8 x 8,4	72	1,36
<u>Boîte de 6 verres</u>				
B . 75 25 220	16	7,5 x 7,8	12	6,39

Code	Ccl	Φ x Ht cm	Sur.	Prix HT
B . 75 25 061	13	6,9 x 7,2	72	0,90
B . 75 25 060	9	6,5 x 6,7	144	0,88
C . 75 25 134	25	8,5 x 9	6	1,76
D . 75 25 130	25	8,5 x 9	6	1,80
E . 75 25 132	25	8,5 x 9	6	1,76

Manhattan

Une gamme emblématique pour les cocktails, en verre trempé solide.



F . FB

G . FH

Code	Ccl	Φ x Ht cm	Sur.	Prix HT
F . 75 28 082	31	8,4 x 8,5	48	2,02
F . 75 28 080	22	7,3 x 8,5	72	1,45
G . 75 28 081	30,5	7 x 13,7	48	2,27

Unie

Verre trempé.



H . Unie

I . Unie

Code	Ccl	Φ x Ht cm	Sur.	Prix HT
H . 75 26 009	33	7,7 x 12,4	48	1,85
H . 75 26 008	28	7,3 x 11,8	72	1,62

Gigogne

Verre trempé.



I .

J .

Code	Ccl	Φ x Ht cm	Sur.	Prix HT
I . 75 25 027	22	7,9 x 7,7	72	1,21
I . 75 25 026	16	7 x 6,9	72	0,87
J . 75 25 025	9	5,8 x 6	72	0,81

Lola

Verre trempé empilable.

■ Empilable



K . Gobelet

L . Gobelet

Code	Ccl	Φ x Ht cm	Sur.	Prix HT
K . 75 25 051	20	7,4 x 7,6	72	1,03
<u>Boîte de 6 verres</u>				
L . 16 05 140	16	7 x 7,1	12	5,52

Empilable

Verre trempé empilable.

■ Empilable



M . Gobelet

N . Gobelet

Code	Ccl	Φ x Ht cm	Sur.	Prix HT
M . 13 10 638	20	7,1 x 9,6	12	6,96
<u>Boîte de 6 verres</u>				
N . 75 25 020	16	6,6 x 7,9	72	1,02

Prisme

Verre trempé.



O . FB

Code	Ccl	Φ x Ht cm	Sur.	Prix HT
O . 75 26 105	22	7,8 x 8,2	48	1,35

Barshine

Verre trempé empilable



A . Chope FH

B . Chope FB

Code	Ccl	Φ x Ht cm	Sur.	Prix HT
A . 75 34 623	38	8,3 x 12,1	24	3,22
B . 75 34 622	39,5	9,1 x 10,1	36	2,77
B . 75 34 621	30,5	8,4 x 9,2	36	2,51
B . 75 34 613	21	7,6 x 8,4	24	2,25



Rock bar

Verre trempé empilable



C . FH



D . FB

Code	Ccl	Φ x Ht cm	Sur.	Prix HT
C . 75 25 081	37	8,3 x 12	36	1,50
D . 75 25 058	20	7,6 x 8,3	36	1,38
D . 75 25 070	27	8,2 x 8,7	36	1,31
D . 75 25 072	7	5,1 x 6,3	54	1,10



Rock bar lounge

Empilable. Coloré dans la masse. Passe au lave-vaisselle.



E . Peach FB

F . Mint FB

G . Blue FB

Code	Ccl	Φ x Ht cm	Sur.	Prix HT
E . 75 34 510	27	8,4 x 9,3	24	2,47
F . 75 34 511	27	8,4 x 9,3	24	2,47
G . 75 34 512	27	8,4 x 9,3	24	2,47

Barshine color

Empilable coloré dans la masse



H . Ice

I . Mint

J . peach

Code	Ccl	Φ x Ht cm	Sur.	Prix HT
H . 75 34 590	30,5	8,4 x 9,2	36	3,13
I . 75 34 598	30,5	8,4 x 9,2	36	3,13
J . 75 34 595	30,5	8,4 x 9,2	36	3,13

Diamond

Design à facettes, effet diamant. En verre coloré dans la masse.



K . Transparent

L . Purple

M . Blue

Code	Ccl	Φ x Ht cm	Sur.	Prix HT
K . 75 34 519	30	8,4 x 9,25	6	2,20
L . 75 34 524	30	8,4 x 9,25	6	2,53
M . 75 34 522	30	8,4 x 9,25	6	2,53



Lyon

Verre trempé empilable



N .

O . Ramequin

Code	Ccl	Φ x Ht cm	Sur.	Prix HT
N . 75 25 018	16	6,6 x 7,9	48	1,01
N . 75 25 019	20	7,1 x 8,6	36	1,09
O . 75 28 125	14	8,5 x 4,1	36	1,17

Habana

Verre trempé



P .

Q .

Code	Ccl	Φ x Ht cm	Sur.	Prix HT
P . 75 25 053	22	7,7 x 8,2	12	1,38
Q . 75 25 052	16	7 x 7,5	12	1,13

Bodéga

Verre trempé.



R . FH

S . FB

Code	Ccl	Φ x Ht cm	Sur.	Prix HT
R . 75 25 087	50	8,8 x 12	36	1,38
R . 75 25 086	37	8,5 x 8,9	36	1,20
S . 75 25 085	20	8 x 5,7	36	0,87





Carré Top Class



Verre cristallin. Base carré, design minimaliste mais moderne.



A .



B .

Code	Ccl	Φ x Ht cm	Sur.	Prix HT
A . 75 36 534	41	6,8 x 15,1	24	4,28
B . 75 36 532	35	8,3 x 9	24	4,13
B . 75 36 531	28,5	7,9 x 8,4	24	4,13

Top Class rond

Design cylindrique parfaitement droit, sobre et pur, léger mais résistant, en verre ultra-blanc et transparent.



C . FH



D . FH

Code	Ccl	Φ x Ht cm	Sur.	Prix HT
C . 75 36 527	44	7,9 x 10,7	24	3,56
D . 75 36 526	37	6,6 x 13	24	3,56
D . 75 36 525	35	7,9 x 8,8	24	3,40

Amétista

Le verre "œnologue" sans pied.



E . FH



F . FB

Code	Ccl	Φ x Ht cm	Sur.	Prix HT
E . 16 15 300	46	8,7 x 12	24	4,26
F . 16 15 301	34	8,7 x 9,1	24	4,07

Diamante

Verre cristallin



G . FB



H . FH

Code	Ccl	Φ x Ht cm	Sur.	Prix HT
G . 75 36 253	38	8,4 x 9,6	24	5,03
H . 75 36 269	48	7,2 x 15,7	24	6,32

Roma

Verre cristallin



I . FB



J . FH

Code	Ccl	Φ x Ht cm	Sur.	Prix HT
I . 75 36 262	30	8 x 8,4	24	4,64
J . 75 36 263	40	7 x 14,2	24	5,03

Son'hyx®

Verre cristallin.



K . Supremo

Code	Ccl	Φ x Ht cm	Sur.	Prix HT
K . 75 36 463	45	10 x 9,8	24	3,62

Bach

Chopes à facettes fond lourd / design barware.



L . FH



M . FH

Code	Ccl	Φ x Ht cm	Sur.	Prix HT
L . 75 36 472	36	6,4 x 15,5	24	4,42
M . 75 36 470	25,5	7,5 x 9	24	4,26
M . 75 36 471	33,5	8,3 x 9,7	24	4,77



Chopes Boules

Verre mécanique.



A . Sand
FH (x4)



B . Sand
FB (x4)



C . Mixte
Monté-carlo



D . Impérial
FB



E . Essence



F . L'esprit du vin

Code	Ccl	Φ x Ht cm	Sur.	Prix HT
------	-----	-----------	------	---------

Boîte de 4 verres

A . 16 18 332	51	7,6 x 14,5	6	6,70
B . 16 18 331	40,5	9,3 x 9,4	6	6,30

Code	Ccl	Φ x Ht cm	Sur.	Prix HT
------	-----	-----------	------	---------

C . 75 41 222	39	7,8 x 11	24	1,90
D . 75 41 077	31	7,8 x 8,7	12	1,55

Code	Ccl	Φ x Ht cm	Sur.	Prix HT
------	-----	-----------	------	---------

E . 16 13 065	35	8 x 10	6	1,46
F . 75 42 075	33	8,5 x 9,9	6	2,92

Convexes

Verre mécanique.

novastyl

Diamond - Electra

Verre mécanique

Silk - L'Eau

Verre non trempé.



G . Allegra



H . Mise en
bouche (x6)



I . Florence
(x3)



J . Diamond



K . Electra



L . Silk



M . L'Eau

Code	Ccl	Φ x Ht cm	Sur.	Prix HT
------	-----	-----------	------	---------

G . 75 41 615	42,5	8,9 x 10,9	24	1,76
Lot de 6 verres				
H . 16 18 062	8	7,7 x 6	6	4,50
Lot de 3 verres				
I . 16 18 371	34	7,1 x 8,7	6	4,28

Code	Ccl	Φ x Ht cm	Sur.	Prix HT
------	-----	-----------	------	---------

J . 75 34 519	30	8,4 x 9,3	6	2,20
K . 75 34 420	38	8,4 x 10	24	3,01

Code	Ccl	Φ x Ht cm	Sur.	Prix HT
------	-----	-----------	------	---------

L . 75 34 004	30	8,2 x 10,7	36	2,53
M . 75 34 106	30	7,4 x 9,8	12	2,44

Milano

Verre trempé.



Luna

Verre non trempé.



Inalto uno - Aurum

Verres Starglass.



N . FH



O . FB



P . FH



Q . FB



R . Inalto Uno FB



S . Aurum

Code	Ccl	Φ x Ht cm	Sur.	Prix HT
------	-----	-----------	------	---------

N . 75 34 208	40	7,5 x 13	12	2,60
O . 75 34 205	8	8,9 x 9,2	12	2,60
O . 75 34 206	30	8,2 x 8,5	12	2,36

Code	Ccl	Φ x Ht cm	Sur.	Prix HT
------	-----	-----------	------	---------

P . 75 30 092	34	7,6 x 13,7	12	2,90
Q . 75 30 090	26	8 x 9,7	12	2,50
Q . 75 30 091	34	8,7 x 10,8	12	3,19

Code	Ccl	Φ x Ht cm	Sur.	Prix HT
------	-----	-----------	------	---------

R . 75 34 462	35	8,5 x 9,5	24	2,99
S . 75 34 457	44,5	8,5 x 10,7	24	3,38
S . 75 34 406	37	8,3 x 9,5	12	3,11

Vina

Verre Arcoroc non trempé.



A . FH



B . FB

Code	Ccl	Φ x Ht cm	Sur.	Prix HT
A . 75 06 033	36	7,6 x 12,1	6	1,82
B . 75 06 032	34	8,9 x 8,3	6	1,82

Outline



Verre Arcoroc non trempé, moderne et raffiné.



C . FH



D . FB

Code	Ccl	Φ x Ht cm	Sur.	Prix HT
C . 75 06 483	37	8,1 x 11,5	24	2,43
D . 75 06 482	32	8,6 x 8,7	24	2,43



Maléa

Verre Arcoroc non trempé.



E .



F .

Code	Ccl	Φ x Ht cm	Sur.	Prix HT
C . 75 06 111	40	7,2 x 14,9	12	1,41
C . 75 06 110	33	6,7 x 14,3	12	1,29

Maléa

Verre Arcoroc non trempé.



G . FH



H . FB

Code	Ccl	Φ x Ht cm	Sur.	Prix HT
I . 75 06 401	35	7,6 x 12,6	24	2,15
J . 75 06 400	30	7,7 x 10,5	24	2,15

Vina



Bord mince et fond allégé sur la forme angulaire.



I . FH



J . FB

Code	Ccl	Φ x Ht cm	Sur.	Prix HT
D . 75 06 432	40	8,7 x 11	24	2,02
E . 75 06 430	35	9,4 x 8,3	24	2,02

Salto

Chopes boule transparente fond lourd.



■ Teintée dans la masse



K . FB



L . FB



M . FH

Code	Ccl	Φ x Ht cm	Sur.	Prix HT
K . 75 06 108	6	4,8 x 6,6	48	1,55
L . 75 06 086	32	9 x 8,4	24	1,91
M . 75 06 085	35	7,6 x 12,1	24	1,91



N . Red FH
(spray)



O . Red FB
(spray)

Code	Ccl	Φ x Ht cm	Sur.	Prix HT
N . 75 06 283	35	7,6 x 12,1	24	4,40
O . 75 06 225	32	9 x 8,4	24	4,40



Q . Salto Ice Blue FH



R . Salto Ice Blue FB

Code	Ccl	Φ x Ht cm	Sur.	Prix HT
Q . 75 06 115	35	7,6 x 12,1	24	2,20
R . 75 06 114	32	9 x 8,4	24	2,20

Glen

Verre mécanique solide.



A . FH



B . FB

Code	Ccl	Φ x Ht cm	Sur.	Prix HT
------	-----	-----------	------	---------

Boîtes de 6 verres

A . 16 18 291	35,5	7 x 14,5	4	15,00
B . 16 18 290	33	8,4 x 9	4	13,50

Élégance

Verre mécanique solide.

novastyl



C . FB
(x3)



D . FH
(x3)

Code	Ccl	Φ x Ht cm	Sur.	Prix HT
------	-----	-----------	------	---------

Lot de 3 verres

C . 16 18 497	31	8,4 x 8,7	10	6,25
D . 16 18 496	33,5	6,8 x 14	6	4,25



Club surf toros



F . Club-Space
(x4)



G . Surf-Toros
(x4)



H . Toros

Code	Ccl	Φ x Ht cm	Sur.	Prix HT
------	-----	-----------	------	---------

Boîte de 4 verres

F . 16 11 965	20	6,8 x 9,95	48	1,95
---------------	----	------------	----	------

Lot de 4 verres

G . 16 11 970	20	6,8 x 9,8	12	1,95
---------------	----	-----------	----	------

Pièce

H . 75 41 093	26	6,6 x 13,2	48	0,75
---------------	----	------------	----	------



ARCOROC



I . Plain can



I . Autonomy

Code	Ccl	Φ x Ht cm	Sur.	Prix HT
------	-----	-----------	------	---------

I . 75 07 347	26	7,5 x 13,4	24	2,24
I . 75 07 470	30	9,2 x 11,5	12	2,46

Chopes apéritif



J . Bonita FH
(x4)



K . Bonita FB
(x4)



M . Aéré



N . Tapas fd léger



O . Génération
(x3)



P . Bodega
(x4)



Q . Arosa

Code	Ccl	Φ x Ht cm	Sur.	Prix HT
------	-----	-----------	------	---------

Boîte de 4 verres

J . 16 18 334	34,5	8,4 x 8,8	6	5,15
K . 16 18 333	24	8,2 x 5,8	6	4,55

Code	Ccl	Φ x Ht cm	Sur.	Prix HT
------	-----	-----------	------	---------

M . 75 34 320	28	7,4 x 8,8	12	2,05
N . 75 41 141	36	8,5 x 8,9	12	1,21

Code	Ccl	Φ x Ht cm	Sur.	Prix HT
------	-----	-----------	------	---------

Lot de 3 verres

O . 16 13 235	25	8,4 x 8,7	48	2,16
---------------	----	-----------	----	------

Boîte de 4 verres

P . 16 13 216	22,5	9 x 5,4	24	8,51
Q . 75 34 079	17	6,5 x 12	6	1,75

Conique

Verre trempé sauf le 8 cl. Désormais en boîte de 6.

ARCOROC

EXTRA
RESISTANT
FULL TEMPERED GLASS



A . FH



B . FH



C . FH



D . Conique
non trempé

Code	Ccl	Φ x Ht cm	Sur.	Prix HT
A . 75 07 499	64	9,1 x 16,1	24	2,05
A . 75 07 068	57	9 x 15	24	2,05
B . 75 07 498	47	8,7 x 13	24	1,98
C . 75 07 497	28	7 x 11,9	24	1,63

Code	Ccl	Φ x Ht cm	Sur.	Prix HT
C . 75 07 496	25	7 x 11,2	48	1,57
C . 75 07 495	20	6,5 x 10,5	48	1,57
D . 75 05 004	8	5 x 7,8	48	1,10



Islande

Verre fond lourd non trempé.

ARCOROC



E . FH



F . FH



G . FH



H . FH



I . Tubo FH



J . Tubo FH



K . FH



L . FB



M . FB

Code	Ccl	Φ x Ht cm	Sur.	Prix HT
E . 75 06 501	36	6,4 x 17	24	1,47
F . 75 06 502	33	6,3 x 15,7	24	1,34
G . 75 06 500	31	5,9 x 16,6	24	1,47
G . 75 06 497	22	5,8 x 13	24	1,33

Code	Ccl	Φ x Ht cm	Sur.	Prix HT
H . 75 06 499	29	6,2 x 14,5	24	1,47
H . 75 06 495	16	5,5 x 10	24	1,33
I . 75 06 494	10	5,1 x 8,7	24	1,33
J . 75 06 498	22	5,3 x 15,2	24	1,33
J . 75 06 496	17	5,2 x 12,5	24	1,33

Code	Ccl	Φ x Ht cm	Sur.	Prix HT
K . 75 06 493	6,5	3,8 x 10,5	72	0,99
L . 75 06 490	38	8,9 x 9,6	24	2,29
L . 75 06 489	30	7,9 x 9,3	24	1,33
M . 75 06 488	20,5	7 x 8,3	24	1,33

Amsterdam - Stockholm

Verre non trempé.



N . Amsterdam
FH



O . Stockholm
FB



P . Stockholm
FB

Code	Ccl	Φ x Ht cm	Sur.	Prix HT
N . 75 05 010	27	6,2 x 13,5	6	1,10
O . 75 05 027	27	7,6 x 9,2	6	1,30
P . 75 05 024	4,5	4,3 x 5,2	48	0,97



Caravelle

Verre mécanique.



Q . FB



R . FB

Code	Ccl	Φ x Ht cm	Sur.	Prix HT
S . 75 30 005	15,5	6,5 x 7	24	1,43
R . 75 30 006	10	5,7 x 6,8	24	0,92
R . 75 30 007	5,3	4,4 x 5,4	48	0,87

Village

Excellente prise en main grâce au col en V. Indication trait de jauge



■ Trait de jauge



A . Carafon Village
trait de jauge



B . 50 cl



C .

Code	Ccl	Φ x Ht cm	Sur.	Prix HT
A . 16 11 722	100	9 x 24,9	6	4,54
B . 16 11 721	50	7,9 x 20,3	6	3,40

Code	Ccl	Φ x Ht cm	Sur.	Prix HT
C . 16 11 720	25	6 x 17,2	16	2,82



Swing top

Verre mécanique.

Le Parfait



D . 100cl



E . 50cl

Code	Ccl	Φ x Ht cm	Sur.	Prix HT
D . 15 10 231	100	8,7 x 32,3	3	3,20
E . 15 10 230	50	6,9 x 29	3	2,75

Giara

Verre mécanique.



F . 100 cl



G . 50 cl

Code	Ccl	Φ x Ht cm	Sur.	Prix HT
F . 75 34 337	100	8,6 x 30,6	6	3,08
G . 75 34 330	50	7,7 x 25,3	12	2,69

Fun color

Verre mécanique.

novastyl



I . Fun

6 COULEURS ASSORTIES

Code	Ccl	Φ x Ht cm	Sur.	Prix HT
I . 16 11 368	100	8,5 x 32	6	2,50

Fraîcheur

Bouteille avec bouchon à vis Twist off.



J . 100 cl



K . 50 cl

Code	Ccl	ø. x Ht cm	Sur.	Prix HT
J . 15 10 236	100	8,4 x 25,2	6	1,80
K . 15 10 235	50	6,7 x 19	6	1,55



City

Verre mécanique.

novastyl



L . 100 cl



M . 50 cl

Code	Ccl	Φ x Ht cm	Sur.	Prix HT
L . 16 18 251	100	6,8 x 25	6	2,80
M . 16 18 250	50	6,8 x 20,3	12	2,15

Optima

Le col solide assure une longévité au produit. Bords renforcés, faciles à servir. Indications et trait de jauge 25, 50, 75 cl et 1 litre. Bouchon à acheter séparément.



A . Carafe à eau



B . Carafe à vin



C . Carafe à vin



D . Bouchon

Code	Ccl	Φ x Ht cm	Sur.	Prix HT
A . 75 36 385	75	8 x 26	6	4,31
B . 75 36 380	25	6 x 19,6	12	3,57

Code	Ccl	Φ x Ht cm	Sur.	Prix HT
C . 75 36 381	50	7,1 x 26,2	6	4,92
D . 75 36 392		5,9 x 4,3	12	3,66

Swing

Base carrée adaptée pour le service et le stockage. Verre mécanique.



E . 100 cl



F .

Code	Ccl	Φ x Ht cm	Sur.	Prix HT
E . 75 34 342	100	8,2 x 31,5	6	3,91
F . 75 34 341	50	6,8 x 25	12	3,39
F . 75 34 340	25	5,5 x 20,6	28	2,58
F . 75 34 343	12,5	5,9 x 13,4	20	2,83



Oriente acqua

Originalité et convivialité, une véritable touche de modernité.



G . Carafe

Code	Ccl	Φ x Ht cm	Sur.	Prix HT
G . 16 64 001	100	8,5 x 35	6	7,22

Elixir

Réalisé avec beaucoup de style, le flacon Elixir de 10 cl est parfait pour les cocktails ou les huiles aromatisées. Bouchon plastique.



H . Carrée 10 cl



I . Ronde 10 cl

Code	Ccl	Φ x Ht cm	Sur.	Prix HT
H . 75 36 440	10	5,7 x 13,5	24	7,67
I . 75 36 441	10	5,2 x 14,2	24	7,67

Optima

Bouchon verseur acier inoxydable 18/8, joint silicone



J . Burette à huile



K . Burette à vinaigre

Code	Ccl	Φ x Ht cm	Sur.	Prix HT
J . 75 36 394	25	7,4 - 5 x 14,3	12	6,64
K . 75 36 395	25	7,4 - 5 x 14,3	12	6,64
L . 75 36 393		2,5 x 12,5	1	4,00

L . Bec verseur

Authentica



M . Bouteille jaugée avec bec verseur inox



Code	Ccl	Φ x Ht cm	Sur.	Prix HT
M . 75 36 343	52,5	6,9 x 31,3	6	6,34
jaugé 50 cl au col de la bouteille				
M . 75 36 342	27,3	5,8 x 26,1	6	5,61
jaugé 25 cl au col de la bouteille				

Fluid

Design unique.

C . 75 15 299
Bouchon seul

Une taille de bouchon
pour les carafes Fluid :
1 L, 75 cl et 50 cl.

ARCOROC



A . Carafe



A . Carafe



B . Carafe



B . Carafe

Code	Ccl	Φ x Ht cm	Sur.	Prix HT
A . 75 15 290	100	10,7 x 26,5	6	9,20
A . 75 15 296	75	10,7 x 21	6	7,31

Code	Ccl	Φ x Ht cm	Sur.	Prix HT
B . 75 15 291	50	9,1 x 19,3	6	5,73
B . 75 15 292	25	7,1 x 13,5	12	4,55
C . 75 15 299		7 x 3,9	1	1,25



Fluid Frosted

Couleur spray pour répondre à la problématique des traces de calcaire.



D . White



E . Bleu



F . Vert

Code	Ccl	Φ x Ht cm	Sur.	Prix HT
D . 75 15 325	75	9,6 x 21	6	8,06
E . 75 15 327	75	9,6 x 21	6	8,06

Code	Ccl	Φ x Ht cm	Sur.	Prix HT
F . 75 15 326	75	9,6 x 21	6	8,06



Carafons vins

Verre non trempé.



G .



H .



I . Carafon carré



J .



K .

Code	Ccl	Φ x Ht cm	Sur.	Prix HT
G . 75 15 112	100	11,9 x 20,3	6	4,11
H . 75 15 111	50	9,8 x 16,4	12	2,74
H . 75 15 110	25	7,8 x 13,2	12	2,29

Code	Ccl	Φ x Ht cm	Sur.	Prix HT
I . 75 15 102	100	12 x 25,5	6	5,43
J . 75 15 101	50	9,6 x 19,9	12	3,16
K . 75 15 100	25	3,6 x 16,2	12	2,50



Ensemble

Design et élégance en verre mécanique très solide.

onis

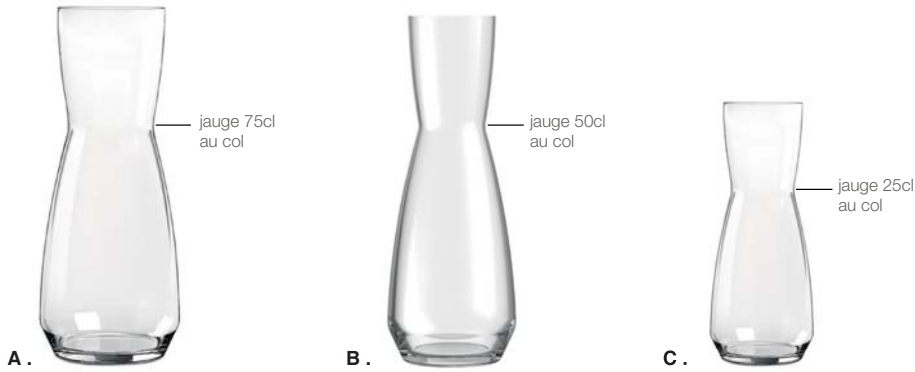

Code	Ccl	Φ x Ht cm	Sur.	Prix HT
A . 16 31 107	107	10 x 25	6	6,01
B . 16 31 106	74	8,9 x 24	6	3,99

Code	Ccl	Φ x Ht cm	Sur.	Prix HT
C . 16 31 105	33	7 x 16,8	12	3,54



Carafes Ypsilon

Verre cristallin



Code	Ccl	Φ x Ht cm	Sur.	Prix HT
D . 16 16 650	100	10,4 x 25,5	6	8,40
D . 16 16 649	50	8,4 x 20,4	6	4,99
D . 16 16 648	25	6,8 x 16,5	12	3,85

Exclusiva

Verre cristallin



Code	Ccl	Φ x Ht cm	Sur.	Prix HT
E . 75 34 389	100	10,2 x 22,5	6	9,82
F . 75 34 388	50	8,3 x 20,4	6	6,95
F . 75 34 387	25	6,7 x 16,5	12	4,81



Atelier



«CE gauge marks». Cristallin SON.hyx®.



G . avec indication jauge

Code	Ccl	Φ x Ht cm	Sur.	Prix HT
G . 75 36 432	120 jg 100	10,8 x 28	6	8,67
G . 75 36 431	64 jg 50	9 x 22,5	6	5,53

Lyonnais

Verre mécanique.



Code	Ccl	Φ x Ht cm	Sur.	Prix HT
H . 16 41 030	46	7 x 29	6	50,72
I . 16 41 031	25	6,3 x 22	6	45,72

Boîte de 6

Misure

Verre mécanique.

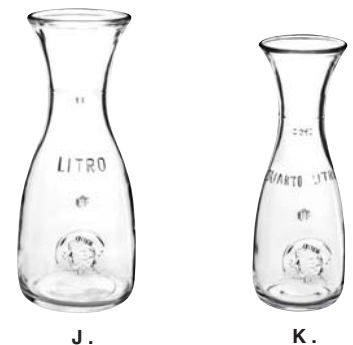

Code	Ccl	Φ x Ht cm	Sur.	Prix HT
J . 16 16 157	100	10,8 x 26,2	6	5,93
K . 16 16 156	50	8,4 x 23,5	12	3,62
K . 16 16 155	25	6,8 x 19	12	2,88

Pichets verre

ARCOROC

novastyl



A. Quadro 50 cl



B. Quadro 120 cl



C. Frigo 105 cl



Code	Ccl	Φ x Ht cm	Sur.	Prix HT
A . 75 15 019	50	12,8 x 15,6	6	5,35
B . 75 15 020	120	12,4 x 24,2	6	6,95

Code	Ccl	Φ x Ht cm	Sur.	Prix HT
C . 16 05 091	105	13 x 24	6	2,50

Pasabahçe
LIVE BEAUTIFUL



D. Spring 100 cl



E. Spring 75 cl



F. Spring 50 cl



G. Pichet



G. Pichet



G. Pichet

Code	Ccl	Φ x Ht cm	Sur.	Prix HT
D . 75 15 087	100	13,4 x 21,8	6	4,52
E . 75 15 086	75	13,4 x 18,6	6	3,96

Code	Ccl	Φ x Ht cm	Sur.	Prix HT
F . 75 15 085	50	13,4 x 14,6	12	3,44
G . 16 10 135	30 jg 25	6 x 12	12	1,73

Code	Ccl	Φ x Ht cm	Sur.	Prix HT
G . 16 10 136	66 jg 50	8 x 15,5	6	2,53
G . 16 10 137	130 jg 100	9,5 x 20	6	3,39



H. Bistrot



H. Bistrot



H. Bistrot



I. Arc



J. Arc

Code	Ccl	Φ x Ht cm	Sur.	Prix HT
H . 16 16 130	25	6,2 x 11,5	12	1,98
H . 16 16 131	50	7,7 x 14,5	12	2,74

Code	Ccl	Φ x Ht cm	Sur.	Prix HT
H . 16 16 132	100	9,2 x 18,6	6	4,09
I . 75 15 001	50	12,5 x 14,6	12	3,23

Code	Ccl	Φ x Ht cm	Sur.	Prix HT
J . 75 15 002	100	15,2 x 20,2	6	4,29
J . 75 15 003	130	13,9 x 21,7	6	5,39

Pichets grès

Renforcé blanc.

novastyl



K.



L.



M.



N.

Code	Ccl	Φ x Ht cm	Sur.	Prix HT
K . 29 40 432	12	7,5 x 8	4	2,00
L . 29 40 436	30	11 x 10,5	72	8,35

Code	Ccl	Φ x Ht cm	Sur.	Prix HT
M . 29 40 433	50	8-12 x 11,5	6	10,85

Code	Ccl	Φ x Ht cm	Sur.	Prix HT
N . 29 40 434	75	8,5-13 x 13	2	13,50

novastyl

OGO



A . Rêverie



B . Rêverie anse



C . Viktor



D . Adam

Code	Ccl	Φ x Ht cm	Sur.	Prix HT
A . 16 11 634	150	15 x 21	6	14,95

Code	Ccl	Φ x Ht cm	Sur.	Prix HT
B . 16 11 635	150	20,5 x 23,5	4	16,50

Code	Ccl	Φ x Ht cm	Sur.	Prix HT
C . 79 12 052	65	10 x 21	6	16,50
D . 79 12 053	120	11,4 x 30	6	17,50

Pasabahçe
LİVE BEAUTİFUL

novastyl



E . Timeless 140 cl



F . Timeless Mixing



G . Botanica



H . 1 L



I . 2 L

Code	Ccl	Φ x Ht cm	Sur.	Prix HT
E . 75 41 313	140	13,4 x 21,7	6	12,42
F . 75 41 318	72	10,5 x 14,5	6	7,19

Code	Ccl	Φ x Ht cm	Sur.	Prix HT
G . 16 13 440	190	18,5 x 27,5	6	11,35

Code	Ccl	Φ x Ht cm	Sur.	Prix HT
H . 16 05 092	100	13,3 x 19,7	6	5,50
I . 16 05 093	200	16,1 x 23,6	6	6,50



J . Macaron



K . Abondance



Code	Ccl	Φ x Ht cm	Sur.	Prix HT
J . 75 15 310	200	17,6 x 32,5	2	59,54

Code	Ccl	Φ x Ht cm	Sur.	Prix HT
K . 75 15 077	160	19 x 23,6	2	38,19



Séries



Galéa
p.4



Mylla
p.5



Open up
p.6



Sublym
p.6



Symétrie
p.7



Distinction
p.8



Primary
p.9



Séquence
p.9



Évidence
p.9

Séries

ARCOROC



Lima
p.10



Cabernet
Vins jeune
p.10



Sensation
Exalt
p.10



Cabernet
Tulip
p.11



Cabernet
Ballon
p.11



Cabernet
Cocktail
p.56



Flûtes
champagne
p.59



Disco
p.29



V. Juliette
p.30

Séries



Broadway
p.31



Vina
p.32



Viticole
p.32



Élégance
p.33



Silhouette
p.33



Normandie
p.34



Amélia
p.34



Princesa
p.35



Linéal
p.35

Séries



Domaine
p.35



Jolly
p.55



Brio
p.57



Shetland
p.63



Stack up
p.63



Starline
p.63



Log
p.64



New York
p.64



Campus
p.65

Séries

OGO



Nonic
p.65



Granity
p.65



Eskale
p.65



FB Salto
p.70



FH Salto
p.70



FH Outline
p.70



Islande
p.72



Conique
p.72



Zénith
p.12

Séries

SCHOTT
ZWIESEL



Néo
p.12



Oslo
p.13



Astral
p.13



Mondial
p.14



Vina
p.14



Ivento
p.15



Belfesta
p.15



Classico
p.17



Taste
p.17

Séries

Luce Bormioli
MADE IN ITALY



Michelangelo
p.18



Rubino
p.18



Diamante
p.19



Linea Bach
p.20



Roma
p.21



Chianti
Supremo p.21



Bach Crista
p.68



Top Class
p.68



Top Class
Square
p.68

Séries

RCR
ORIGINALE
CANTAGLIANO



Timeless
p.24



Alkemist
p.26



Tiki Eturia
p.27



Aurum
p.36



In Alto
Tre Sensi
p.36



Nexo
p.36



Florian
p.37



Celebrazione
p.37



Esclusiva
p.38

Bormioli
ROCCO

Séries



Snifter
p.54



Mules
p.60



Oxford
p.62



Ypsilon
p.63



Bodega
p.67



Rock bar
lounge
p.67



Diamond
p.67



Barshine
p.67



Luna
p.69

Séries

Pasabahce
LIFE GLASSWARE



Milano
p.69



Arosa
p.71



Timeless
p.40



Elysia
p.43



Essence
p.44



Tulip
p.44



Inao
p.46



Enoteca
Ballon
p.46



Allegra
p.46

Séries



Comptoir
p.47



Ivory
p.47



Next
Empilable
p.61



Casablanca
p.61



Tapas
fd léger
p.71



Caldera
p.45



Savage
p.45



Picardie
p.66



Unie
p.66

Séries



Séries



Séries

Séries

novastyl



Manhattan
p.66



Mignon
p.48



Rhin
p.48



Florence
p.49



Noa
p.49



Riviera
p.50



Gatsby
p.51



Génération
p.71



Élégance
p.71

Séries

onix



SPKSY
p.52



Roma
p.52



Adventure
p.53



Pentagon
p.53



Facets
p.53



Hampshire
p.53



ICON
p.53



Tarq
p.53



Pineapple
p.53

Complément



Swing top
p.73



Giara
p.73



Village
p.73



Fraîcheur
p.73



Optima
p.74



Huillier
p.74



Carafon
p.75



Carafe
p.75



Mesure
p.76

Complément

Personnalisation



Ypsilon
p.76



Pots
p.76



Bistrot
p.77



Pichets
p.77



Brocs
p.77



Pichets
p.78



Décanter
p.78



Sérialisation
p.82



Gravure
p.82

V.Juliette jaugé (grappe)

3 niveaux : 10 - 12,5 et 15 cl pour 3 contenances best-sellers

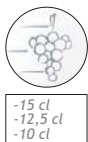

A . V.Juliette

Code	Ccl	Φ x Ht cm	Sur.	Prix HT
------	-----	-----------	------	---------

A . 75 10 313 30 7,8 x 18,8 24 3,82



Cabernet jaugé (grappe)

Esthétique et discrète, la jauge est élégante sans trop s'imposer. Cristallin

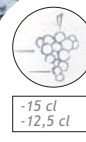

B . Vins jeunes

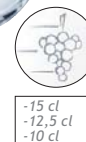

C . Cabernet Tulipe

Code	Ccl	Φ x Ht cm	Sur.	Prix HT
------	-----	-----------	------	---------

B . 75 10 312 35 9 x 20 24 4,34
C . 75 10 314 35 8,1 x 20,2 24 4,34

Viticole (ellipse) ARCOROC

Ces verres présentent une ellipse, véritable repère pour verser en un clin d'œil les doses précises de vin, 14,5 ou 12,5 cl.



D . Viticole

Code	Ccl	Φ x Ht cm	Sur.	Prix HT
------	-----	-----------	------	---------

D . 75 11 082 21,5 6,5 x 15,5 48 3,29

Cabernet (ellipse)

Cristallin



E . Tulip 35

Code	Ccl	Φ x Ht cm	Sur.	Prix HT
------	-----	-----------	------	---------

E . 75 10 403 35 8,1 x 20,2 24 4,34



Inao novastyl

Le véritable verre effilé cristallin Inao, bord fin coupé à froid.



F . Inao (x6)

Code	Ccl	Φ x Ht cm	Sur.	Prix HT
------	-----	-----------	------	---------

F . 19 71 885 21 6,5 x 16 **Boîte de 6 verres** 8 12,05

Tester

Verre mécanique bord à chaud.



G .



H .

Code	Ccl	Φ x Ht cm	Sur.	Prix HT
------	-----	-----------	------	---------

G . 75 41 115 21,5 7 x 15,5 12 1,44
H . 75 41 442 21,5 jge12 7 x 15,5 12 2,27
I . 75 41 479 21,5 jge14-12 7x 15,5 12 2,27



1 Gravure laser

Nous proposons à partir de 19 références standard suivies et en stock.

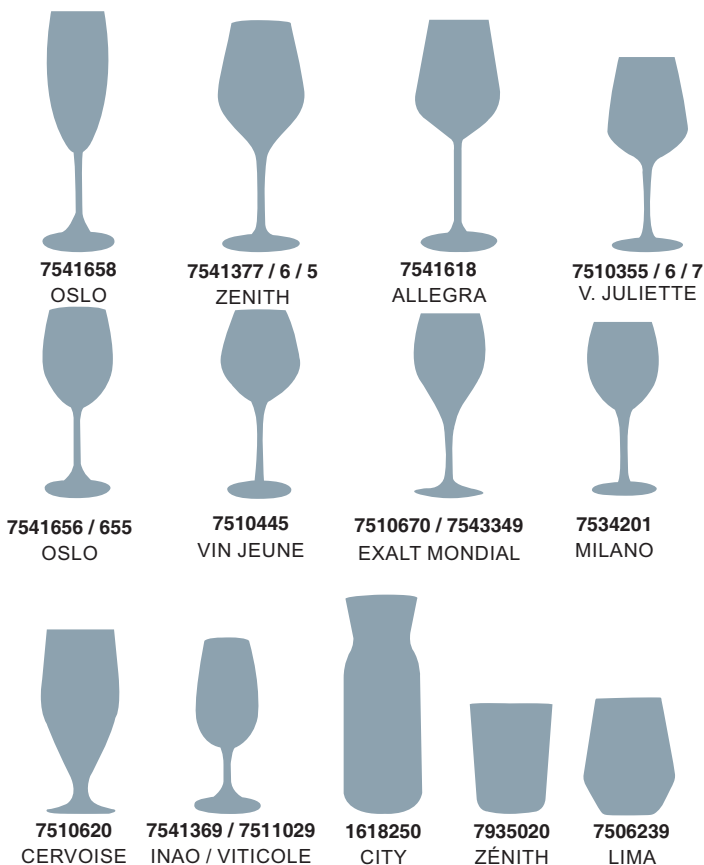

2 Tarif Frais techniques 45,00 €

Supplément gravure par quantité *	Tarif HT Trait de jauge	Tarif HT Écriture simple détournée	Tarif HT gravure complexe ou remplie écriture épaisse (+4mm)		
	Moins de 10 secondes	Moins de 40 secondes	Environ 1 minute	Environ 1 min 30	Au-delà de 2 min
De 120 à 250 pièces	1.00€	1.32€	1.50€	1.68€	2.18€
De 251 à 600 pièces	0.83€	1.05€	1.25€	1.43€	1.93€
De 601 à 1000 pièces	0.75€	0.93€	1.13€	1.31€	1.81€
1001 pièces et plus	0.67€	0.83€	1.03€	1.21€	1.71€

5 EXEMPLE DE SÉRIGRAPHIE



La gravure laser sur verre permet une inscription très précise et garantit une longévité dans le temps. Le motif obtenu est un dépoli blanc satiné.

3 EXEMPLE DE GRAVURE

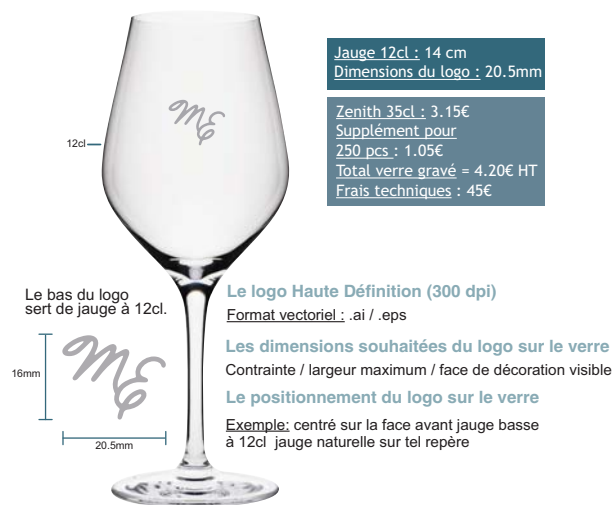

4 Personnalisation sur verre

Nous vous proposons aussi un autre procédé de décoration en sérigraphie couleur

EMAIL EPOXY

> Panel de couleurs plus important (encres organiques)

À partir de 250 pièces minimum.
Nous consulter pour plus d'informations.

> Possibilité de décorer une plus grande surface

> En couleur toutes couleurs pantones simples (sauf or Et métalliques)

> Minimum 240 pcs

> Frais techniques 45,00 €

> Devis à la demande

> Tarif dégressif négociable avec les quantités

> Possible dépoli blanc imitation gravure

PROCESSUS

1 SOUMETTRE VOTRE PROJET

Pour toute demande de personnalisation, un devis sur mesure vous est proposé, accompagné d'un dossier explicatif du processus.

3 CHOIX DU SUPPORT

Aperçu de vaisselle personnalisable

L'ensemble des supports disponibles sont présentés dans le dossier complet.



Plate



Creuse



Ovale



Bol

Aperçu numérique du design sous maquette

PDF fournis sous 2 jours ouvrés.

5 TARIFICATION

Tableau des prix

Notez que le prix du support n'est pas inclus dans ces tarifs.

Frais techniques : 50€

Quantité pièces*	Tarif HT Logo	Tarif HT Logo + Bordure
	1 couleur	3 couleurs
De 600 à 1000 pièces	0.85€	1.50€
De 1000 à 2000 pièces	0.70€	1.20€
De 2000 à 3000 pièces	0.60€	1.00€
De 3000 à 5000 pièces	0.45€	0.90€
De 5000 à 10000 pièces	0.40€	0.85€

*Catégorie tarifaire soumise à validation par devis

Précision : un surcoût est appliqué pour chaque couleur additionnelle (Logo ou bordure).

2 BESOINS (À NOUS FOURNIR)

Fichier Haute Définition (300 dpi)

Format vectoriel : .ai / .eps

Choix des couleurs

► Aucune limite de principe quant au choix des couleurs Pantone, sous réserve de validation technique.

PALETTE DE COULEURS PERSONNALISABLE

Pour personnaliser vos décors et bordures, merci de nous communiquer vos références Pantone.

Si besoin de couleur spécifique, nous préciser les éléments et comptez 10 jours supplémentaires de production.

4 ÉCHANTILLONNAGE

Design approuvé

Échantillon(s) fournis pour un tarif de 150€ sous 3 semaines. (remboursé en cas de commande)



Logo seul



Logo & Bordure

6 PRODUCTION ET EXPÉDITION

Validation des maquettes / échantillons

Le processus de production finale commence et vos produits sont fabriqués et prêts à l'expédition sous 6 à 7 semaines*.

*1000 pcs ou plus la date de livraison peut varier.

Vous rapprochez de nos services.

Exemple de personnalisation avec logo

Plate Lona : 5,60€
 Nombres de pcs : 240 pcs
 Supplément couleur/pc : 0.85€
 Frais techniques : 50€
 Total : 1598€ HT
 Prix unitaire : 6,65€ pc



+ Pour toute demande de décors supplémentaires ou spécifiques, merci de nous contacter. Nous étudierons votre projet.

► Les informations sont à confirmer avant production et sont soumises à la validation de l'équipe technique.

PROCESSUS DÉCORATION RÉALISÉE EN FRANCE



1 SOUMETTRE VOTRE PROJET

Lorsque vous nous contactez pour une demande de personnalisation, nous vous fournirons un devis sur mesure, ainsi qu'un dossier complet expliquant les étapes du processus.

3 CHOIX DU SUPPORT

Aperçu de vaisselle personnalisable

L'ensemble des supports disponibles sont présentés dans notre dossier complet.



Plate sans aile

Plate avec aile

Ovale

Pizza

Pasta

Tasse et sous-tasse

Aperçu numérique du design sous maquette

PDF fournis sous 2 jours ouvrés.

5 TARIFICATION

Tableau des prix PHR

Notez que le prix du support et le transport n'est pas inclus dans ces tarifs.

Frais techniques : 50€

Quantité pièces*	Tarif HT Logo	Tarif HT Logo + Bordure
	1 couleur	1 couleur
De 96 à 199 pièces	2.25€	4.50€
De 199 à 299 pièces	1.85€	3.95€
De 300 à 499 pièces	1.65€	3.75€
De 500 à 799 pièces	1.35€	3.55€
De 800 à 1000 pièces	1.25€	3.45€
+ 1000 pièces	1.15€	3.30€
+ 2000 pièces	1.05€	3.25€

*Catégorie tarifaire soumise à validation par devis

Précision : un surcoût de 0,50 est appliqué pour chaque couleur additionnelle (Logo ou bordure).

2 BESOINS (À NOUS FOURNIR)

Fichier Haute Définition (300 dpi)

Format vectoriel : .ai / .eps

Limites de couleur

4 couleurs maximum pour les logos.

6 couleurs maximum pour les décors de bordure.

PALETTE DE COULEURS PERSONNALISABLE

Pour personnaliser vos décors et bordures, merci de nous communiquer vos références Pantone.

Si besoin de couleur spécifique, nous préciser les éléments et comptez 10 jours supplémentaires de production.



4 ÉCHANTILLONNAGE

Design approuvé

Échantillon(s) fournis pour un tarif de 150€ sous 3 semaines. (remboursé en cas de commande)



Logo seul

Logo & Bordure

6 PRODUCTION ET EXPÉDITION

Validation des maquettes / échantillons

Le processus de production finale commence et vos produits sont fabriqués et prêts à l'expédition sous 6 à 7 semaines*.

*3000 pcs ou plus la date de livraison peut varier. Vous rapprochez de nos services.

Exemple de personnalisation avec logo sur assiette plate Ø21cm

Plate Thera : 2,16€
 Nombres de pcs : 600 pcs
 Supplément couleur/pc : 1,35€
 Frais techniques : 50€
 Total : 2156€ HT
 Prix unitaire : 3,56€ pc



+ Pour toute demande de décors supplémentaires ou spécifiques, merci de nous contacter. Nous étudierons votre projet.



Sigma

Artisanale et authentique en porcelaine.



Reckless

Sombre et sophistiquée : un noir anthracite résistant en porcelaine.



Nuance

Discrète, texturée et craquelée, un filet souligné en porcelaine.



Omega

Aile courte, simple, épuré et empilable. Porcelaine blanche résistante.



02

VAISSELLE



Personnalisation vaisselle	84 à 85
OGO	88 à 103
ID Fine	104 à 111
Bonna	112 à 121
Novastyl	122 à 135
Porcelaine blanche	136 à 143
Pastas, Salades & Spécialités	144 à 146
Sarreguemines	147
Opal	148 à 151
Vaisselle verre et saladiers	152 à 154
Plats individuels	155
Ramequins et bols	156 à 157
Coupes à dessert	158 à 159
Mise en bouche	160 à 161
Service à thé et café	162 à 167
Tasses blanches et colorées	168 à 169
Photothèque vaisselle	170 à 173



OGO

LIVING

INTRODUCTION

OGO Living développe des collections d'art de la table alliant design épuré, qualité durable et fonctionnalité.

ÉLÉGANCE

Pensée pour accompagner le quotidien des professionnels, la marque propose des produits fiables et contemporains qui subliment chaque service avec simplicité et élégance.

ROBUSTESSE

Offrant des produits à la fois modernes et intemporels, OGO Living est le choix parfait pour ceux qui recherchent qualité et style au quotidien.

PRATICITÉ



JEU DE TEXTURES

Porcelaine raffinée, mêlant harmonieusement textures, matières striées et finitions mates.



Compatible à l'utilisation du lave-vaisselle et du micro-ondes



URUS

Nous avons imaginé cette collection pour sublimer vos repas et transformer votre table en une véritable expérience gastronomique, digne des plus grands restaurants étoilés.

Fabriquée en porcelaine haut de gamme, cette collection se distingue par un subtil jeu de matières et de textures, combinant raffinement et modernité.

Son design unique s'inspire des formes délicates et organiques des oursins, que l'on retrouve dans les lignes des assiettes et des bols, apportant une touche naturelle et artistique à votre table.

URUS

Collection by OGO

La délicate porcelaine

La porcelaine est un matériau réputé dans la vaisselle, connue pour sa délicatesse et son raffinement. Malgré son apparence délicate, c'est en réalité un matériau très robuste et résistant, notamment à la chaleur et aux chocs légers, ce qui en fait un choix idéal pour une vaisselle quotidienne qui dure dans le temps.

La polyvalence de la porcelaine convient pour une variété d'utilisations, que ce soit pour des plats froids ou des plats chauds, passant du four à la table, mais également le micro-ondes et le lave-vaisselle.

Matériau non-poreux, la porcelaine n'absorbe pas les odeurs, les saveurs ou les bactéries, ce qui rend la vaisselle en porcelaine facile à nettoyer et hygiénique.



Porcelaine Qualité Hôtelière



Résistance aux chocs et aux rayures



Alliez élégance et sobriété avec une vaisselle subtilement ornée, conçue pour sublimer vos repas avec finesse.

Un jeu de texture

Notre collection de vaisselle URUS met en valeur une esthétique raffinée et naturelle grâce à ses formes organiques et ses couleurs douces, mêlant le blanc pur au beige subtil.

Les assiettes, ainsi que les bols et tasses, s'inspirent des irrégularités délicates des oursins, conférant à chaque pièce une allure unique et sophistiquée.

Les lignes texturées et les reliefs légèrement striés évoquent les motifs naturels et irréguliers que l'on retrouve dans les coquilles d'oursins.

Ces éléments texturés ne sont pas simplement esthétiques, ils captent et reflètent la lumière de manière élégante, accentuant la finesse de la porcelaine utilisée.

Les teintes blanches et beiges apportent une touche de sobriété et d'élégance intemporelle, permettant à cette collection de se fondre harmonieusement dans n'importe quel style de table, tout en mettant en valeur les plats qu'elle accueille.

Parfaite pour dresser une table digne des plus grandes tables étoilées, cette collection marie avec brio simplicité organique et luxe contemporain.



Une collection bi-matière

Urus



Plate 28,5



Plate 28,5



Plate 31



Plate 31

Désignation	Coloris	Code	Φ x Ht cm	Sur.	Prix HT
Plate	Bleu	79 32 175	31 x 3,5	4	17,95
	Beige	79 32 190	31 x 3,5	4	17,95
	Bleu	79 32 176	28,5 x 3	4	14,95
	Beige	79 32 191	28,5 x 3	4	14,95



Creuse 110cl



Creuse 110cl



Gourmet 22cl



Gourmet 22cl

Désignation	Coloris	Code	Φ x Ht cm	Sur.	Prix HT
Creuse	Bleu	79 32 177	20 x 7	4	12,95
	Beige	79 32 192	20 x 7	4	12,95
Gourmet	Bleu	79 32 178	23 x 5,3	4	10,95
	Beige	79 32 193	23 x 5,3	4	10,95



Urus



Désignation	Coloris	Code	Ccl	Φ x Ht cm	Sur.	Prix HT
Saucière	Bleu	79 32 179	10	6,5 x 5,5	8	4,50
	Beige	79 32 194	10	6,5 x 5,5	8	4,50
Bol	Bleu	79 32 184	10	8 x 4,5	12	3,95
	Beige	79 32 199	10	8 x 4,5	12	3,95
	Bleu	79 32 205	11	8 x 5	12	3,95
	Bleu	79 32 185	24	10 x 5,7	12	5,50
	Beige	79 32 200	24	10 x 5,7	12	5,50
	Bleu	79 32 206	80	18 x 5	4	12,95
Beige	79 32 207	80	18 x 5	4	12,95	



VAISSELLE



Désignation	Coloris	Code	Ccl	Φ x Ht cm	Sur.	Prix HT
Tasse	Bleu	79 32 182	21	9,2 x 6,5	6	5,50
	Beige	79 32 197	21	9,2 x 6,5	6	5,50
	Bleu	79 32 180	9	6,7 x 5,2	6	4,50
	Beige	79 32 195	9	6,7 x 5,2	6	4,50
Saucoupe	Bleu	79 32 183		15 x 1,8	6	4,50
	Beige	79 32 198		15 x 1,8	6	4,50
	Bleu	79 32 181		12 x 1,7	6	4,50
	Beige	79 32 196		12 x 1,7	8	4,50

DESIGN ARTISANAL

Apportez une touche d'authenticité à votre table avec notre gamme Ora. Alliant design artisanal et résistance professionnelle, elles sont idéales aussi bien pour les particuliers exigeants que pour les restaurateurs.



Résistance aux chocs et aux rayures



Porcelaine
Qualité Hôtelière



Plate

Creuse

Désignation	Code	Ccl	Φ x Ht cm	Sur.	Prix HT
Plate	79 32 356		20,5 x 2,5	4	8,50
	79 32 355		27 x 3,3	4	12,50
Creuse	79 32 358	34	15,5 x 3,5	4	7,55
	79 32 357	66	21 x 4,5	4	11,65



Coupelle

Mug

Tasse

Désignation	Code	Ccl	Φ x Ht cm	Sur.	Prix HT
Coupelle	79 32 360	26	11,5 x 6	6	4,95
	79 32 359	57,5	15,5 x 7,5	4	7,95
Mug	79 32 362	32	9 x 10	4	5,95
Tasse	79 32 361	16	7,5 x 6,5	4	3,95



Plate



Ovale



Creuse



Coupe

Désignation	Code	Ccl	Φ x Ht cm	Sur.	Prix HT
Plate	79 32 367		23 x 3,5	4	9,95
	79 32 366		27,5 x 3,8	4	11,50
Ovale	79 32 365	41,5	23,5 x 15,5 x 4,5	4	9,95
Creuse	79 32 369	40	18 x 6,5	6	7,95
Coupe	79 32 368	66	20,5 x 5,4	4	10,95



Résistance aux chocs et aux rayures



Coupelle



Saucière

Désignation	Code	Ccl	Φ x Ht cm	Sur.	Prix HT
Coupelle	79 32 371	57,5	16 x 7,5	4	9,25
	79 32 370	7,5	7 x 4	12	2,95
Saucière	79 32 372	10	9 x 6,7 x 5,7	12	4,95

Vénus



Plate

Creuse



Coupe

Ovale

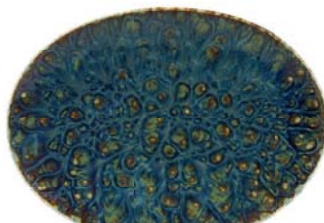

Désignation	Code	Ccl	Φ x Ht cm	Sur.	Prix HT
Plate	79 32 212		20 x 2	6	4,50
	79 32 210		27 x 2	6	6,95
Creuse	79 32 211	92,4	21 x 5	6	5,25
Coupe	79 32 217	35	14 x 3,5	3	6,90
	79 32 218	190	19 x 4	2	9,90
	79 32 219	320	25 x 6,5	8	19,90
Ovale	79 32 213		21 x 17 x 2,5	3	6,25



Tasse



Sous Tasse



Bol



Coupelle



Désignation	Code	Ccl	Φ x Ht cm	Sur.	Prix HT
Tasse	79 32 215	17,5	7,5 x 6,5	12	2,65
Sous Tasse	79 32 216		14 x 2	6	2,35
Coupelle	79 32 208	24	13 x 6	6	5,90
	79 32 209	55	17 x 7,5	2	7,90
Bol	79 32 214	49	16 x 6	2	5,85



Résistance aux chocs et aux rayures

DÉCOR

Émaux réactif, fusion harmonieuse des tons bleus et verts.



Saturne

TEXTURE

Sa conception en émail réactif rend chaque pièce unique.

Variations naturelles dans les teintes et les textures.



Coupelle 13



Plat rectange



Plate 21



Creuse

Désignation	Code	Ccl	Φ x Ht cm	Sur.	Prix HT
Plate	79 32 297		21 x 2	6	4,50
	79 32 295		27 x 3	6	6,80
Creuse	79 32 296	92,4	21 x 5	6	5,60
Coupelle	79 32 298	24	13 x 6	6	6,00
	79 32 299	55	17 x 7,5	2	7,80
Plat rectange	79 32 300		30 x 9,5 x 2	6	7,80



Volcano



Plat rectange

Désignation	Code	Φ x Ht cm	Sur.	Prix HT
Plat Rect	26 15 297	29,5 x 9,5 x 1,5	6	7,90
	26 15 298	46,5 x 10 x 1,5	6	11,06

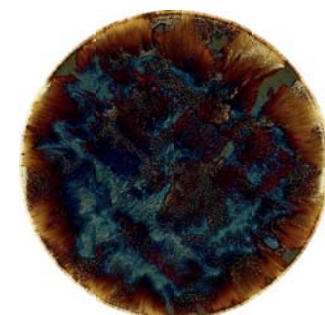
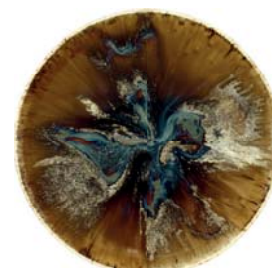

Plate 27



Calotte



Plate 20



Bol

Désignation	Code	Ccl	Φ x Ht cm	Sur.	Prix HT
Plate	26 15 296		20 x 2	6	4,39
	26 15 294		27 x 2	6	7,19
Calotte	26 15 295	80	21 x 5	6	5,52
Bol salade	26 15 299	55	16 x 5	2	6,15

Grès

Oli 

OGO
Living



Plate 22

Plate 27,5



Coupe 15,3

Coupe 20,5



Résistance aux chocs et aux rayures



Désignation	Code	Ccl	Ø x Ht cm	Sur.	Prix HT
Plate	79 32 386		22 x 2	6	4,95
	79 32 385		27,5 x 3	6	6,11
Coupe	79 32 388	60	15,3 x 00	6	6,00
	79 32 387	100	20,5 x 7,8	4	12,75



Mug



Paire Tasse

Désignation	Code	Ccl	Ø x Ht cm	Sur.	Prix HT
Mug	79 32 389	38	8 x 9	6	4,31
Paire Tasse	79 32 390	22	8,3 x 6,2	6	5,55
Soucoupe/			14,7 x 2		

 New products
Nouveautés



Plate 20,5

Plate 20,5

Désignation	Code	Ccl	Φ x Ht cm	Sur.	Prix HT
Plate	79 32 377		20,5 x 2,8	6	4,80
	79 32 376		21,5 x 3	6	4,80
	79 32 375		26,5 x 2,8	6	5,95



VAISSELLE



Coupelle 10cl

Coupelle 22cl

Désignation	Code	Ccl	Φ x Ht cm	Sur.	Prix HT
Coupelle	79 32 380	10	8,7 x 3	6	2,05
	79 32 379	22	12 x 4,7	6	2,80

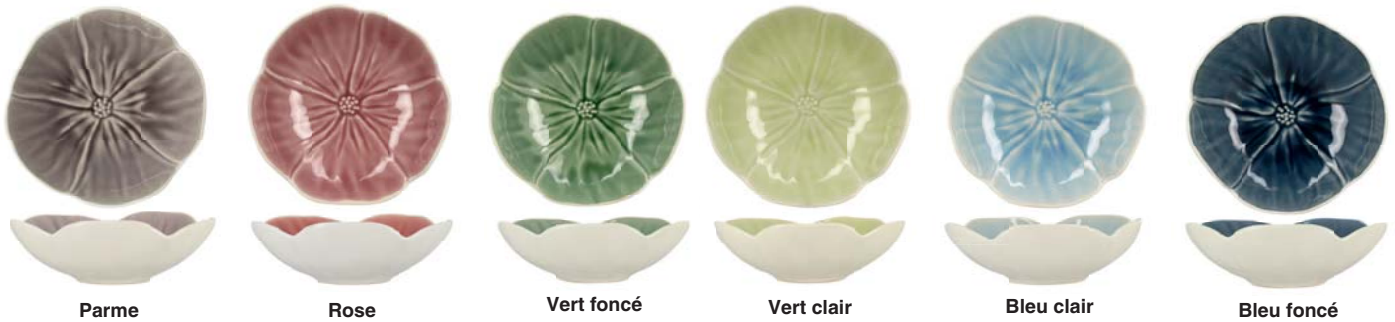

Parme

Rose

Vert foncé

Vert clair

Bleu clair

Bleu foncé

Désignation	Coloris	Code	Ccl	Φ x Ht cm	Sur.	Prix HT
Coupelle	Parme	79 32 378	32	16 x 5	6	5,20
	Rose	79 32 255	32	16 x 5	6	5,20
	Vert foncé	79 32 256	32	16 x 5	6	5,20

Désignation	Coloris	Code	Ccl	Φ x Ht cm	Sur.	Prix HT
Coupelle	Vert clair	79 32 257	32	16 x 5	6	5,20
	Bleu clair	79 32 258	32	16 x 5	6	5,20
	Bleu foncé	79 32 259	32	16 x 5	6	5,20



Plate



Coupe

Désignation	Code	Ccl	Φ x Ht cm	Sur.	Prix HT
Plate	79 32 077		20,5 x 2	6	4,85
	79 32 075		27,5 x 2,5	6	6,25
Coupe	79 32 078	100	20 x 5	4	6,25
	79 32 079	55	16 x 4,5	6	4,50



Coupelle 21cl



Bol 50cl



Pasta 20cl



Creuse 95cl



Saucière 8cl



Saucière 20cl



Mug

Désignation	Code	Ccl	Φ x Ht cm	Sur.	Prix HT
Saucière	79 32 160	8	5,3 x 6,2	6	3,25
	79 32 161	20	7 x 8,4	6	4,25
Mug	79 32 084	45	12,5 x 8,5 x 10,5	6	3,25



Coupelle 100cl

Désignation	Code	Ccl	Φ x Ht cm	Sur.	Prix HT
Coupelle	79 32 244	21	12 x 8 x 4	6	3,95
Creuse	79 32 242	95	21 x 7	4	6,25
Bol	79 32 243	50	17 x 6	6	4,95
Pasta	79 32 240	20	27 x 6,5	4	14,95
Coupelle	79 32 076	100	20 x 7	6	5,75



Plate 20,5

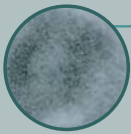

Plate 27,5



Creuse

Désignation	Code	Φ x Ht cm	Sur.	Prix HT
Plate	79 32 073	20,5 x 2	12	4,85
	79 32 070	27,5 x 2,5	6	6,25
Creuse	79 32 252	21 x 19,8	4	6,25



TEXTURE

Céramique émaux réactifs ton pierre : chaque pièce est unique et différente.

Finition brillante.

Sous face émaillée.



Saucière 8cl



Saucière 20cl

Coupelle 21cl



Coupe



Bol 50cl

Désignation	Code	Ccl	Φ x Ht cm	Sur.	Prix HT
Saucière	79 32 166	20	7 x 8,4	6	4,25
Bol	79 32 253	50	17 x 6	6	4,95
Coupelle	79 32 254	21	12 x 8	6	3,95
Coupe	79 32 071	100	20 x 5	4	6,25
	79 32 072	55	16 x 4,5	6	4,50



Katanga



Plate 27,5



Plate 20,5



TEXTURE

Création unique chaque pièce est décorée à la main.

Design sophistiqué de qualité supérieure.



Coupelle



Désignation	Code	Ccl	Φ x Ht cm	Sur.	Prix HT
Plate	79 32 116		20,5 x 1,5	6	4,85
	79 32 115		27,5 x 2,5	6	6,25
Coupelle	79 32 117	100	20 x 7	6	6,25

Grenada



Plate 27,5



Plate 20,5



Coupe 100cl



Bol 50cl



Coupelle 21cl

Désignation	Code	Ccl	Φ x Ht cm	Sur.	Prix HT
Plate	79 32 121		20,5 x 2	24	4,85
	79 32 120		27,5 x 2,5	12	6,25

Désignation	Code	Ccl	Φ x Ht cm	Sur.	Prix HT
Coupe	79 32 122	100	20 x 5	16	6,25
Bol	79 32 263	50	17 x 6	6	4,95
Coupelle	79 32 264	21	12 x 8 x 4	6	3,95

ORA

New collection by OGO



Alliant design artisanal et résistance professionnelle.

OGO
LIVING



ÉLÉGANCE DISCRÈTE

Grâce à son blanc pur, notre gamme apporte une touche d'élégance discrète qui s'adapte à toutes les ambiances.

Son design épuré traverse les tendances et convient à tous les styles de table. Elle s'intègre parfaitement dans tous les types de décorations de table, qu'elles soient modernes, classiques ou minimalistes.

Parfaitement empilable



Résistance aux chocs et aux rayures



Porcelaine
Qualité Hôtelière



Plate



Creuse

Désignation	Code	Φ x Ht cm	Sur.	Prix HT
Plate	79 32 322	18 x 2,3	6	1,65
	79 32 317	20 x 2,5	12	2,00
	79 32 316	22 x 2,7	6	2,54
	79 32 315	24,5 x 3	12	2,73

Désignation	Code	Ccl	Φ x Ht cm	Sur.	Prix HT
Creuse	79 32 321	12	13,5 x 2	12	2,19
	79 32 320	18	15 x 2,5	12	2,63
	79 32 319	40	20 x 3,8	12	3,17
	79 32 318	55	22 x 4	12	3,36

Thera



Plate 30,5

Plate 28



Plate 24

Plate 19

Désignation	Code	Φ x Ht cm	Sur.	Prix HT
Plate	79 32 305	30,5 x 3	6	5,95
	79 32 306	28 x 3	6	3,75
	79 32 307	26,5 x 2,5	6	3,30
	79 32 308	24 x 2,5	6	2,55
	79 32 309	22,5 x 2,5	6	2,35
	79 32 310	21 x 2,5	6	2,10
	79 32 311	19 x 2,2	6	1,95



Dessert

Creuse

Désignation	Code	Ccl	Φ x Ht cm	Sur.	Prix HT
Dessert	79 32 314		16 x 2	6	1,75
	79 32 312		14 x 1,8	6	1,65
Creuse	79 32 313	40	23 x 4	6	2,45

DESIGN ÉPURÉ



Son design épuré traverse les tendances et convient à tous les styles de table, puisqu'elle s'intègre parfaitement dans tous les types de décorations de table, qu'elles soient modernes, classiques ou minimalistes.

Sa simplicité met en valeur les plats sans jamais détourner l'attention.

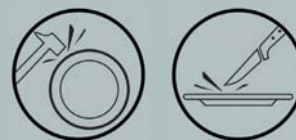

Résistance aux chocs et aux rayures



Porcelaine
Qualité Hôtelière

New products
Nouveautés



INTRODUCTION

ID Fine conçoit des collections de porcelaine pensées pour les professionnels, où l'élégance du design rencontre l'exigence de la fonctionnalité et de la durabilité.

RÉSISTANCE

Portée par le concept Sustainable Harmony, la marque développe des collections compatibles entre elles dans le temps. Cette approche unique permet de faire évoluer les mises en scène et les présentations sans avoir à renouveler les stocks existants, dans une logique responsable et maîtrisée.

ROBUSTESSE

ID Fine accompagne ainsi les chefs et les acteurs de l'hôtellerie-restauration avec une vision créative, cohérente et performante, conçue pour répondre aux exigences d'aujourd'hui tout en s'inscrivant dans le long terme.

DURABILITÉ



Delta

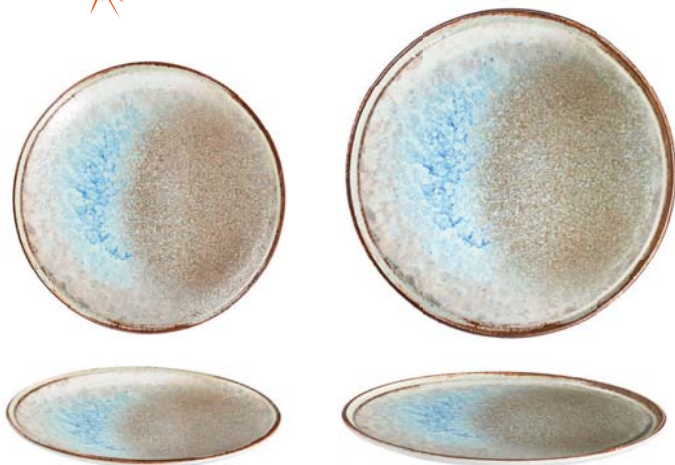

Plate 23

Pizza 31



Coupelle

Bol

Désignation	Code	Φ x Ht cm	Sur.	Prix HT
Plate	25 14 145	15 x 1,8	12	4,53
	25 14 146	17 x 1,9	12	5,12
	25 14 147	19 x 2,2	12	5,96
	25 14 148	21 x 2,2	12	6,64
	25 14 149	23 x 2,3	12	7,58
	25 14 150	25 x 2,5	12	8,43
	25 14 151	27 x 2,7	12	9,03
	25 14 152	28,5 x 2,6	12	10,83
	25 14 153	30 x 3,1	12	12,93
	Pizza	25 14 162	31 x 1,6	6

Désignation	Code	Ccl	Φ x Ht cm	Sur.	Prix HT
Coupelle	25 14 156	6	10 x 2,4	24	3,06
	25 14 157	24	15 x 3	12	5,19
	25 14 201	9	10 x 3,6	24	3,22
Bol	25 14 202	42	16 x 5,3	12	6,21
	25 14 203	62	18 x 5,9	6	8,23

Delta 



Ovale 33x21



Ravier 12x8



Rectangle 22x10



Rectangle 27x20

Désignation	Code	Φ x Ht cm	Sur.	Prix HT
Ovale	25 14 171	14 x 9 x 2,4	12	9,11
	25 14 172	18 x 12 x 2,4	12	10,11
	25 14 173	23 x 15 x 2,7	12	12,13
	25 14 174	28 x 18 x 3	6	14,48
	25 14 175	33 x 21 x 3	6	16,00
	25 14 176	37 x 24 x 3	6	17,78

Désignation	Code	Ccl	L x l x Ht cm	Sur.	Prix HT
Ravier	25 14 185	4,5	10 x 7 x 2,2	12	6,01
	25 14 186	10,5	12 x 8 x 2,9	12	7,83
	25 14 187	18	14 x 10 x 3,2	12	9,15
	25 14 188	35	17 x 12 x 4	12	11,40
Rectangle	25 14 195		22 x 10 x 2,2	12	11,71
	25 14 191		27 x 20 x 2,3	6	20,78



Creuse



Pasta 28



Pasta 29

Désignation	Code	Ccl	Φ x Ht cm	Sur.	Prix HT
Creuse	25 14 158	55	20 x 3,8	12	6,67
	25 14 159	77	22 x 4,3	12	10,52
	25 14 160	110	25 x 4,5	12	13,54
Pasta	25 14 165	17	20 x 3,5	12	8,14
	25 14 166	42	25 x 5,4	12	11,35
	25 14 167	56	28 x 5,8	6	12,91
	25 14 168	46	29 x 5,8	6	16,18



RÉSISTANCE DES COULEURS

Chaque pièce offre un effet réactif unique, pour un design original et distinctif.

Porcelaine fine au design moderne



Résistance aux chocs et aux ébréchures





Résistance aux chocs et aux ébréchures



Pizza

Plat ovale



Plat rectangle



Plate 30

Creuse 20

Désignation	Code	Ccl	Φ x Ht cm	Sur.	Prix HT
Plate	25 14 217		15 x 1,8	12	5,75
	25 14 228		16,5 x 2,2	12	6,81
	25 14 219		19 x 2,2	12	7,10
	25 14 229		21 x 2,1	6	9,75
	25 14 222		25 x 2,5	12	9,96
	25 14 230		25,5 x 2,3	6	12,33
	25 14 223		27 x 2,7	12	11,71
	25 14 231		28 x 2,4	6	13,01
Creuse	25 14 225		30 x 3	6	15,82
	25 14 241	55	20 x 3,8	12	10,37
	25 14 243	114	25 x 4,5	12	14,45



Coupelle 46cl

Bol 42cl

Désignation	Code	Ccl	Φ x Ht cm	Sur.	Prix HT
Pizza	25 14 246		31 x 1,6	6	17,42
Plat Ovale	25 14 252		23 x 15 x 2,7	12	16,07
Plat rectangle	25 14 271		27 x 20 x 2,3	6	23,68

Désignation	Code	Ccl	Φ x Ht cm	Sur.	Prix HT
Coupelle	25 14 281	15	10 x 3,6	12	5,17
	25 14 282	46	14 x 5,3	12	9,55
Bol	25 14 288	9	10 x 3,6	24	4,71
	25 14 289	42	16 x 5,3	12	9,09

MELLOW

New collection by ID Fine



Glaçure verte réactive qui offre un aspect unique à chaque pièce  ID Fine



Plate 27

Pizza

Désignation	Code	Ccl	Φ x Ht cm	Sur.	Prix HT
Plate	25 14 560		15 x 1,8	12	6,05
	25 14 563		21 x 2,2	12	8,25
	25 14 565		25 x 2,5	12	10,48
	25 14 566		27 x 2,7	12	11,66
	25 14 568		30 x 3	6	16,66
Pizza	25 14 579		31 x 1,6	6	18,33



Coupe 62cl

Creuse 77cl



Plat ovale

Pasta



Assiette ovale

Plat rectangle

Désignation	Code	Ccl	Φ x Ht cm	Sur.	Prix HT
Coupe	25 14 655	62	18,5 x 3,9	12	9,66
Creuse	25 14 586	77	22 x 4,3	12	13,64
Plat ovale	25 14 611		26 x 2,1	12	11,83
	25 14 612		32 x 2,3	6	15,96
Pasta	25 14 592	42	25 x 5,4	12	13,21

Désignation	Code	Ccl	Φ x Ht cm	Sur.	Prix HT
Ass. ovale	25 14 601		23 x 15 x 2,7	12	16,92
	25 14 602		28 x 18 x 3	6	18,80
Plat rectangle	25 14 623		27 x 20 x 2,3	6	24,93



Coupelle 9cl



Coupelle 21cl



Coupelle 46cl



Bol 38cl



Bol 52cl



Bol 42cl

Désignation	Code	Ccl	Φ x Ht cm	Sur.	Prix HT
Coupelle	25 14 644	9	10 x 3,6	24	4,96
	25 14 665	21	10 x 5,7	12	6,69
	25 14 636	46	14 x 5,3	12	10,05
Bol	25 14 654	38	13,5 x 4,9	12	8,95
	25 14 666	52	14 x 6,6	6	10,05
	25 14 645	42	16 x 5,3	12	9,57



Mug 26cl

Expresso 8cl

Café 20cl

Soucoupe

Désignation	Code	Ccl	Φ x Ht cm	Sur.	Prix HT
Mug	25 14 689	26	8,3 x 9	6	7,26
Expresso	25 14 673	8	6,4 x 5,7	12	5,68
Soucoupe	25 14 672		12 x 1,7	12	4,01
Café	25 14 675	20	8,5 x 6,7	12	7,35
Soucoupe	25 14 674		12 x 1,7	12	4,01





Plate 25

Creuse

Désignation	Code	Ccl	Φ x Ht cm	Sur.	Prix HT
Plate	25 14 715		20 x 1,9	12	4,51
	25 14 716		25 x 2,3	12	6,93
	25 14 717		29 x 2,8	6	9,10
Creuse	25 14 723	33	22 x 3,5	12	8,24



Plat ovale 22x00

Coupelle



Plat ovale 32x00

Saladier

Désignation	Code	Ccl	Φ x Ht cm	Sur.	Prix HT
Plat ovale	25 14 727		21 x 2,7	12	10,22
	25 14 731		22 x 2,6	12	6,14
	25 14 728		26 x 2,9	6	12,30
	25 14 729		32 x 3,5	6	14,01
Coupelle	25 14 735	8	11 x 3,7	12	2,99
	25 14 736	20	16 x 4,6	12	5,77
	25 14 737	45	18 x 5,8	6	7,48
Saladier	25 14 738	92	26 x 6,3	6	8,26



Tasse à thé

Sous-tasse

Désignation	Code	Ccl	Φ x Ht cm	Sur.	Prix HT
Tasse à Thé	25 14 744	18	7,9 x 7	12	4,30
Sous-tasse	25 14 746		12 x 2,4	12	2,44
	25 14 745		16 x 1,9	12	3,03

Modest 



Plate 21 - Noir

Plate 21 - Vert

Désignation	Code	Coloris	Ccl	Φ x Ht cm	Sur.	Prix HT
Plate	25 14 331	Noir		15 x 1,8	12	4,09
	25 14 334	Noir		21 x 2,2	12	5,54
	25 14 336	Noir		25 x 2,5	12	7,08
	25 14 337	Noir		27 x 2,7	12	7,87
	25 14 339	Noir		30 x 3,1	6	11,25
	25 14 454	Vert		21 x 2,1	6	6,67
	25 14 455	Vert		25,5 x 2,3	6	8,44
	25 14 456	Vert		28 x 2,4	6	9,38



Résistance aux chocs et aux ébréchures



Pizza - Noir

Pasta - Noir

Désignation	Code	Coloris	Ccl	Φ x Ht cm	Sur.	Prix HT
Pizza	25 14 365	Noir		31 x 1,6	6	12,38
Pasta	25 14 370	Noir	147	20 x 3,5	12	7,56
	25 14 371	Noir	45	25 x 5,4	12	10,78



Creuse - Noir

Coupe - Vert



Assiette Ovale - Vert

Plat Ovale - Vert

Désignation	Code	Coloris	Ccl	Φ x Ht cm	Sur.	Prix HT
Creuse	25 14 359	Noir	77	22 x 4,3	12	9,21
Coupe	25 14 497	Vert		17 x 5,4	6	8,69
	25 14 498	Vert		21 x 5,5	6	10,17
Coupelle	25 14 495	Vert	15	10 x 3,6	12	3,68
Ass. Ovale	25 14 486	Vert		28 x 18 x 3	6	14,10
Plat Ovale	25 14 487	Vert		33 x 21 x 3	6	15,67

 New products
Nouveautés



INTRODUCTION

Bonna est la marque de porcelaine hôtelière haut de gamme, conçue pour un usage intensif.

RÉSISTANCE

Combinant résistance, design contemporain et continuité de gamme.

ESTHÉTISME

Style premium, finitions maîtrisées, réassort fiable : une solution solide pour les restaurants qui veulent une table esthétique, durable et cohérente.

DURABILITÉ

3 fois moins de renouvellement grâce à la garantie ébréchure.



Lagoon Ocean



Plate 26



Plate 15

Désignation	Code	Φ x Ht cm	Sur.	Prix HT
Plate	26 33 300	15 x 1,5	12	5,14
	26 33 301	18 x 1,5	6	8,34
	26 33 302	22 x 1,5	6	12,22
	26 33 303	26 x 1,5	4	14,44

Lagoon Ocean 



VAISSELLE



Creuse



Bol

Désignation	Code	Ccl	Φ x Ht cm	Sur.	Prix HT
Creuse	26 33 305	30	17 x 4,5	6	9,73
	26 33 306	60	21 x 6	6	16,76
	26 33 307	130	26 x 7,5	6	22,68
Bol	26 33 312	45	22 x 7	2	22,15



Ovale

Désignation	Code	Ccl	L x l x Ht cm	Sur.	Prix HT
Ovale	26 33 309	65	27 x 16 x 5	4	14,01
	26 33 310	95	31 x 20 x 5,5	3	17,99



PORCELAINE

Chaque pièce se distingue par un mélange harmonieux de tons bleu profond et sable, rappelant les courants marins et les fonds marins.

Parfaite pour créer une ambiance sophistiquée et apaisante, cette collection transforme chaque repas en une expérience mémorable.





Digital Printing



Plate

Creuse

Désignation	Code	Φ x Ht cm	Sur.	Prix HT
Plate	26 32 648	30 x 2	6	11,97
	26 32 655	27 x 2	12	8,35
	26 32 653	21 x 2,5	12	6,14
Dessert	26 32 649	17 x 2	12	4,73
Creuse	26 32 654	25 x 2,5	6	12,55
	26 32 658	23 x 4,5	6	10,45



Pasta

Pizza*

Désignation	Code	Ccl	Φ x Ht cm	Sur.	Prix HT
Pasta	26 32 659		27 x 4,5	6	13,13
Pizza	26 32 665*		32 x 2	6	14,65



Moove

Ovale

Désignation	Code	Φ x Ht cm	Sur.	Prix HT
Moove	26 32 652	34 x 16	12	22,58
	26 32 651	23 x 16	12	14,28
Ovale	26 32 650	31 x 24	6	13,60



PORCELAINE

Finesse de la porcelaine au délicat motif inspiré du palais de l'Alhambra qui allie culture orientale et élégance.

Résistance aux chocs et aux rayures.



Edge chip warranty
Résistant contre les ébréchantures

*Out of warranty / Non compris.



Plate Ø22



Plate Ø18



Creuse



Ovale



ÉLÉGANCE & SIMPLICITÉ

Chaque pièce est soigneusement conçue avec des lignes uniques qui embrassent délicatement les assiettes, leur offrant une liberté esthétique sans limite.

Parées de tons doux et blancs, les pièces Albus présentent une forme douce, sans angles vifs, apportant une touche distinctive aux créations des chefs.



Résistance aux chocs et aux rayures



Désignation	Code	Ccl	Ø x Ht cm	Sur.	Prix HT
Plate	26 33 318		18 x 1,9	12	3,31
	26 33 319		22 x 2,2	12	4,30
	26 33 320		24 x 2	12	4,92
	26 33 321		28 x 2,4	6	6,08
	26 33 322		30 x 1,9	6	8,34
Creuse	26 33 323*	30	23 x 3,5	6	6,96
	26 33 324*	46	27 x 5	6	9,33
	26 33 325*	40	28 x 5,2	6	9,88
Ovale	26 33 326*		22 x 14 x 1,8	6	4,81
	26 33 327*		28 x 18 x 2	6	6,41
	26 33 328*		32 x 21 x 2	6	8,12



Edge chip warranty
Résistant contre les ébréchantures

*Out of warranty / Non compris.



New products
Nouveautés



Plate





Creuse

Désignation	Code	Ccl	Φ x Ht cm	Sur.	Prix HT
Plate	26 33 102		21 x 2	12	5,30
	26 33 103		25 x 2,5	12	5,89
	26 33 104		27 x 2,6	12	8,35
Creuse	26 33 106	60	25 x 4,5	6	8,93



RÉSISTANT

Les assiettes en porcelaine blanche de la gamme EAST mettront en valeur vos plats et apporteront une touche d'élégance sur votre table à toute occasion.

Résistance aux chocs et aux rayures



Coupelle

Bol

Désignation	Code	Ccl	Φ x Ht cm	Sur.	Prix HT
Coupelle	26 33 109	13	11 x 10 x 3,3	12	3,52
Bol	26 33 110	40	16 x 5,6	12	4,96



Plate Hygge

Dessert Hygge

Ovale Hygge

Plate et Dessert Gourmet

Désignation	Code	Φ x Ht cm	Sur.	Prix HT
Plate Hygge	26 32 834*	22 x 2	6	9,61
Dessert Hygge	26 32 826*	16 x 2	12	6,72
Ovale Hygge	26 32 830*	34 x 23 x 2	6	22,58
Plate Gourmet	26 32 832	27 x 2	12	8,35
Plate Gourmet	26 32 828	21 x 2	12	7,09
Dessert Gourmet	26 32 827	17 x 2	12	4,73



Pizza

Pasta

Désignation	Code	Φ x Ht cm	Sur.	Prix HT
Pizza	26 32 835*	32 x 1,1	6	14,65
Pasta	26 32 838*	27 x 5,7	6	13,13



DÉCOR

Toute l'essence de la région méditerranéenne s'étend vers le bleu et tous les vents portent les arômes invitants les saveurs exquises.

Les motifs de couleur bleu méditerranéen sont dessinés à la main individuellement. Texture originale de l'inspiration à l'arrière plan de Viento.

Cette collection est devenu le symbole élaboré d'un été sans fin sur la table.



Edge chip warranty

Résistant contre les ébréchures

*Out of warranty / Non compris.



Digital Printing



Creuse

Bol Vago

Désignation	Code	Ccl	Φ x Ht cm	Sur.	Prix HT
Creuse	26 32 837	130	25 x 4,5	6	14,54
	26 32 836	100	23 x 4,5	6	10,45
Bol Vago	26 32 842*	47	18 x 5,5	12	10,70



Rectangle 01

Rectangle 02

Vago

Désignation	Code	Ccl	Φ x Ht cm	Sur.	Prix HT
Rectangle 01	26 32 840		23 x 16	12	16,49
Rectangle 02	26 32 841		34 x 16	12	26,14
Vago	26 32 831		36 x 17 x 1	12	19,43

Luca Mozaic 



DÉCOR

Inspirés de pièces mosaïque.

Collection audacieuse et affirmée, pour ceux qui cherchent un design qui accompagne l'harmonie des différentes saveurs qu'ils réunissent dans l'assiette.



Digital Printing



Plate

Creuse 100 cl

Désignation	Code	Ccl	Φ x Ht cm	Sur.	Prix HT
Plate	26 32 689		21 x 2	12	6,72
	26 32 690		27 x 2	6	8,35
Creuse	26 32 692	100	23 x 4,5	6	10,45



Bol

Pizza

Pasta 40 cl

Désignation	Code	Ccl	Φ x Ht cm	Sur.	Prix HT
Pizza	26 32 691*		32 x 2	6	13,95
Pasta	26 32 695	40	28 x 4,5	6	15,54
Bol	26 32 698	40	16 x 7	12	7,77



Résistance aux chocs et aux rayures

Lunar Océan



Digital Printing



Plate Hygge

Pasta Hygge

Désignation	Code	Ccl	Φ x Ht cm	Sur.	Prix HT
Plate hygge	26 32 101		16 x 2	12	7,03
	26 32 102		22 x 1,7	6	10,03
	26 32 103		28 x 1,8	6	14,18
Pasta hygge	26 32 105	90	28 x 5,9	6	19,79



VAISSELLE





TEXTURE

Originale avec ses options de couleurs pastels.

Cette collection apporte une touche innovante sur les tables, avec une application spéciale d'émail complétée par la technologie Envisio Engraved.



Petite coupelle

Grande coupelle

Désignation	Code	Ccl	Φ x Ht cm	Sur.	Prix HT
Coupelle	26 32 110	12	10 x 2,3	12	4,41
	26 32 111	45	14 x 5	12	7,93

Grès vitrifié

Hornfels

bonna



Plate

Creuse

Désignation	Code	Ccl	Φ x Ht cm	Sur.	Prix HT
Plate	26 32 948		16 x 2	12	6,41
	26 32 949		21 x 2	6	8,76
	26 32 950		26 x 2	6	10,87
	26 32 951		28 x 2	6	11,91
Creuse	26 32 952*	35	19 x 5	6	9,24
	26 32 953*	100	26 x 7	6	13,59



Creuse

Désignation	Code	Ccl	Φ x Ht cm	Sur.	Prix HT
Coupelle	26 32 954*	3,5	6 x 2,5	12	2,63
	26 32 955*	7	8 x 3	12	3,10
	26 32 956*	41,5	13 x 5	12	6,72
Bol	26 32 944	100	18,5 x 6	6	9,00



DÉCOR VOLCANIQUE

Hornfels, une collection inspirée des plages de sable volcanique noir et des colonnes de basalte, offre des couleurs terreuses saisissantes.

Fabriquée en grès de haute qualité, elle allie durabilité et élégance pour une expérience culinaire exceptionnelle.



Vaisselle compatible lave-vaisselle et micro-ondes



Résistance aux chocs et aux rayures



Assiette café



Mug



Tasse

Désignation	Code	Ccl	L x l x Ht cm	Sur.	Prix HT
Assiette Café	26 32 960*		20 x 17 x 1	12	6,77
Tasse	26 32 957*	10	8,5 x 6 x 5	6	3,98
	26 32 958*	20,5	12,5 x 9,5 x 6	6	5,83
Mug	26 32 959*	32	12 x 8,5 x 9	12	6,56



Edge chip warranty

Résistant contre les ébréchures

*Out of warranty / Non compris.



Plate

Bol

Coupelle

Désignation	Code	Ccl	Φ x Ht cm	Sur.	Prix HT
Plate	26 32 508		21 x 2	12	7,45
	26 32 476		23 x 2	12	8,56
	26 32 477		25 x 2	12	9,30
	26 32 509		27 x 2	12	9,97
Bol	26 32 485	40	16 x 5,5	12	8,35
Coupelle	26 32 487	29	12 x 5	24	7,30

SPIRALE ARTISTIQUE

Les assiettes Aura, en porcelaine peinte à la main, captivent avec leur palette de trois coloris envoûtants : Terrain, Space et Passion. Leur effet peinture spirale ajoute une dimension artistique à chaque repas.

Peint à la main

Résistance aux chocs et aux rayures

Compatible lave-vaisselle et micro-ondes

Aura Passion



Edge chip warranty
Résistant contre les ébrèchures

*Out of warranty / Non compris.



Plate

Creuse

Pasta

Bol

Coupelle

Coupelle

Désignation	Code	Ccl	Φ x Ht cm	Sur.	Prix HT
Plate	26 32 578		17 x 2	12	5,78
	26 32 579		21 x 2	12	7,45
	26 32 583		25 x 2	12	9,30
	26 32 582		27 x 2,5	12	9,97
	Creuse	26 32 574	100	23 x 4,5	6

Désignation	Code	Ccl	Φ x Ht cm	Sur.	Prix HT
Pasta	26 32 575	40	24 x 5,5	6	12,76
	26 32 576	40	27 x 5,5	6	15,86
Bol	26 32 586	40	16 x 5,5	12	7,95
Coupelle	26 32 571	29	12 x 5	24	7,30
	26 32 587	6	8 x 3 x 4,5	24	5,57



novastyl®

INTRODUCTION

Novastyl propose des collections d'art de la table destinées aux professionnels de l'hôtellerie, de la restauration et des collectivités, en mettant l'accent sur la fonctionnalité et la résistance.

RÉSISTANCE

Pensés pour un usage intensif, les produits Novastyl accompagnent le quotidien des établissements avec des solutions pratiques, fiables et faciles à intégrer à tous les styles de service.

PRATIQUE

Sobres et efficaces, les collections Novastyl répondent aux besoins essentiels des professionnels tout en apportant une touche actuelle à la table.

EFFICACE



Atome 



Plate 25

Creuse

Désignation	Code	Ccl	Ø x Ht cm	Sur.	Prix HT
Plate	25 13 472		19 x 2,5	12	2,95
	25 13 470		25 x 3,7	12	3,95
Creuse	25 13 471	70	20,5 x 5,7	12	2,95

QUALITÉ

En faïence apporte une touche d'élégance et d'authenticité à votre table.

Robuste et facile à entretenir, elle est parfaite pour sublimer vos repas au quotidien.



Résistance aux chocs et aux rayures

Nuance 

Plate 20

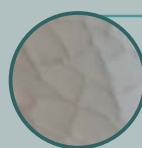

Ovale

**TEXTURE**

Sa texture craquelée confère à chaque pièce un caractère unique.

Son design intemporel en font un choix parfait pour votre table tout en gardant une touche naturelle et minimaliste.



Résistance aux chocs et aux rayures



Creuse



Coupelle

Désignation	Code	Ccl	Φ x Ht cm	Sur.	Prix HT
Plate	26 15 737		20 x 2	6	3,95
	26 15 735		27 x 2	6	5,95
Ovale	26 15 738		19 x 10,8 x 3	6	4,15
	26 15 739		23,5 x 13,5 x 3	6	4,95

Désignation	Code	Ccl	Φ x Ht cm	Sur.	Prix HT
Creuse	26 15 736	100	21 x 5	6	4,75
Coupelle	26 15 744	35	15,5 x 5,5	6	3,25

Porcelaine

Palmeraie



Résistance aux chocs et aux rayures

novastyl



Plate 27



Creuse



Ovale



Tasse et soucoupe

Désignation	Code	Ccl	Φ x Ht cm	Sur.	Prix HT
Plate	26 15 797		21 x 2	24	4,20
	26 15 795		27 x 2	6	5,45
Creuse	26 15 796		21 x 5	6	4,50
Ovale	26 15 798		24 x 17	4	4,75
Bol	26 15 806	49	16 x 6	2	4,75
Tasse	26 15 807	16	8 x 6	12	2,75
Soucoupe	26 15 808		13 x 2,5	12	1,80

Spirale



QUALITÉ

En faïence au motif de cercles bleus apporte une touche d'élégance et d'authenticité à votre table.

Robuste et facile à entretenir, elle est parfaite pour sublimer vos repas au quotidien.

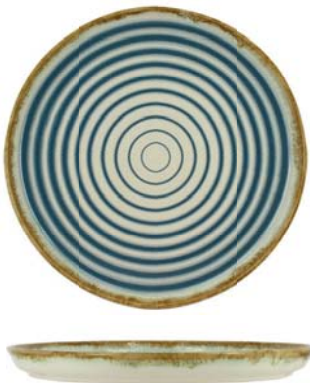

Plate 27



Creuse

Désignation	Code	Ccl	Φ x Ht cm	Sur.	Prix HT
Plate	25 13 467		21 x 2,4	12	3,95
	25 13 465		27 x 2,6	12	5,95
Creuse	25 13 466	75	22 x 4,8	12	5,95



 New products
Nouveautés

Botanic



DÉCOR

Apportez la douceur de la nature à votre table avec ce décor fleuri et délicatement orné d'oiseaux.



Plate 26



Creuse



Plate 21



Désignation	Code	Ccl	Φ x Ht cm	Sur.	Prix HT
Plate	26 15 522		21 x 1,5	6	4,06
	26 15 520		26 x 2,5	6	5,40
Creuse	26 15 521	80	21 x 5,5	6	4,48

Maka



novastyl



Plate 27



Calotte



Plate 21



Coupelle



Résistance aux chocs et aux rayures



Désignation	Code	Ccl	Φ x Ht cm	Sur.	Prix HT
Plate	26 15 107		21 x 1,5	6	4,69
	26 15 105		27 x 2,5	6	5,89
Calotte	26 15 106	80	21 x 5,5	6	4,81
Grande calotte	26 15 108	110	26 x 4,5	6	6,56
Coupelle	26 15 109	18	10 x 4,5	6	3,04
	26 15 110	35	12 x 5	6	3,88
	26 15 111	55	16 x 6	6	5,41

Byzance



Coupelle



Mini Tajine



Plate



Creuse



Désignation	Code	Ccl	Φ x Ht cm	Sur.	Prix HT
Plate	26 15 402		20 x 2	6	4,07
	26 15 400		27 x 2	6	5,20
Creuse	26 15 401	80	21 x 5	6	4,38
Ovale	26 15 403		18,5 x 10,5 x 3	4	6,13
Coupelle	26 15 404	35	12 x 5	6	5,92
Mini Tajine	26 15 415	11,1	14,5 x 10	1	6,39
Tajine	26 15 416	88,1	24,5 x 15,5	1	14,63

Lachat



Plate 26



Plate 21



Calotte



Coupelle

Désignation	Code	Ccl	Φ x Ht cm	Sur.	Prix HT
Plate	26 34 010		26 x 2	6	5,41
	26 34 012		21 x 2	6	4,36

Désignation	Code	Ccl	Φ x Ht cm	Sur.	Prix HT
Calotte	26 34 011	60	21 x 4	6	4,20
Coupelle	26 34 013	40	14 x 5	6	3,83

Natura



INSPIRATION NATURE

Assiettes aux teintes éclatantes, inspirées de la nature, avec une texture mosaïque évoquant la croûte terrestre. Une gamme aux coloris captivants allant du cuivré irisé aux teintes bleutées.



Résistance aux chocs et aux rayures



Plate 26



Plate 21



Creuse



Coupelle

Désignation	Code	Φ x Ht cm	Sur.	Prix HT
Plate	26 34 017	21 x 2,5	6	4,75
	26 34 015	26 x 2,5	6	5,75

Désignation	Code	Ccl	Φ x Ht cm	Sur.	Prix HT
Creuse	26 34 016		21 x 4	6	4,75
Coupelle	26 34 019		23 x 5	6	5,60
	26 34 018		14 x 5,4	6	3,40

Jasmin 

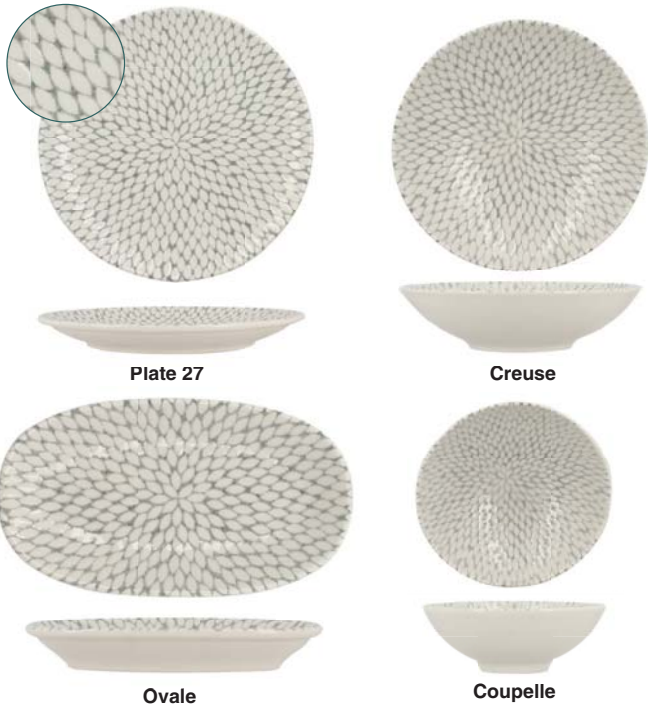

Désignation	Code	Ccl	Φ x Ht cm	Sur.	Prix HT
Plate	26 15 707		20 x 2	6	3,95
	26 15 705		27 x 2	6	5,95
Creuse	26 15 706	80	21 x 5	6	4,75
Ovale	26 15 708		19 x 10 x 3	6	5,15
	26 15 709		23,5 x 13 x 3	6	4,95
Coupelle	26 15 713	35	15 x 5	6	3,25

INSPIRATION NATURE

Son motif délicat, inspiré des pétales finement entrelacés, crée un effet visuel tout en finesse.



Résistance aux chocs

Aqua 

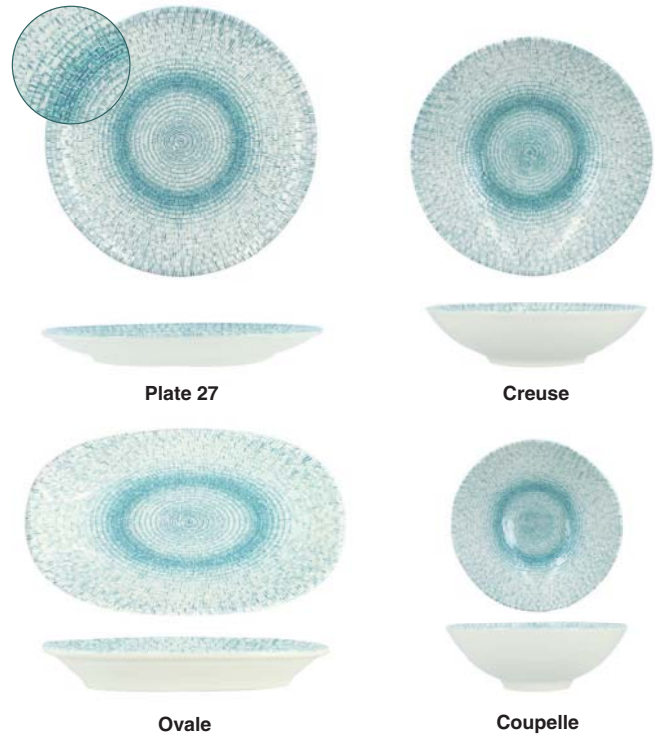

Désignation	Code	Ccl	Φ x Ht cm	Sur.	Prix HT
Plate	26 15 717		20 x 2	6	4,15
	26 15 715		27 x 2	6	5,95
Creuse	26 15 716	80	21 x 5	6	4,75
Ovale	26 15 718		19 x 10 x 3	6	4,15
	26 15 719		23 x 13 x 3	6	4,95
Coupelle	26 15 723	35	15 x 5,5	6	3,25

Savane



Plate 26



Creuse



Plate 20



Désignation	Code	Ccl	Ø x Ht cm	Sur.	Prix HT
Plate	32 05 692		20 x 2	12	2,55
	32 05 690		26 x 2,5	12	3,25
Creuse	32 05 691	60	20,5 x 4	12	2,95

Dune



Plate 26



Creuse







Plate 20

RELIEF

Design épuré et contemporain, avec ses tons crème naturels, elle allie sobriété et sophistication.

Sa texture en relief géométrique apporte une touche artistique, parfaite pour sublimer vos tables sans les surcharger.

Résistance aux chocs et aux rayures



Désignation	Code	Ccl	Ø x Ht cm	Sur.	Prix HT
Plate	32 05 927		20 x 2	12	2,55
	32 05 925		26 x 2,5	12	3,25
Creuse	32 05 926	60	20,5 x 4	12	2,95

Jaipur



Plate



Mug



Bol

Désignation	Code	Ccl	Φ x Ht cm	Sur.	Prix HT
Plate	32 35 137		20 x 2,5	6	4,65
	32 35 135		27 x 2,5	6	5,95
Creuse	32 35 136	70	19 x 5	6	4,95
Bol	32 35 138	60	15,5 x 7	6	4,25
Mug	32 35 139	35	12 x 9 x 10	6	4,25



FLEUR ÉCLATANTE

Les assiettes Jaipur, arborant un motif floral en relief aux couleurs pétillantes, sont l'éclatant témoignage d'une élégance artistique, apportant une touche vibrante et raffinée à votre expérience culinaire.



Décor en relief

Héraclée



Résistance aux chocs et aux rayures

ESPRIT MÉDITERRANÉEN

La vaisselle Héraclée en grès, arborant des motifs méditerranéens frais, est disponible en bleu et vert, ajoutant une note vibrante d'inspiration méditerranéenne à votre table.



Plate 27



Plate 19



Creuse



Coupelle

Désignation	Couleur	Code	Φ x Ht cm	Sur.	Prix HT
Plate	Bleu	32 05 492	19 x 2	12	2,55
	Vert	32 05 497	19 x 2	12	2,55
	Bleu	32 05 490	27 x 3	12	3,25
	Vert	32 05 495	27 x 3	12	3,25

Désignation	Couleur	Code	Ccl	Φ x Ht cm	Sur.	Prix HT
Creuse	Bleu	32 05 491	90	20 x 5,3	12	2,95
	Vert	32 05 496	90	20 x 5,3	12	2,95
Coupelle	Bleu	32 05 493	50	16,7 x 5,7	12	2,95
	Vert	32 05 498	50	16,7 x 5,7	12	2,95

Jade 

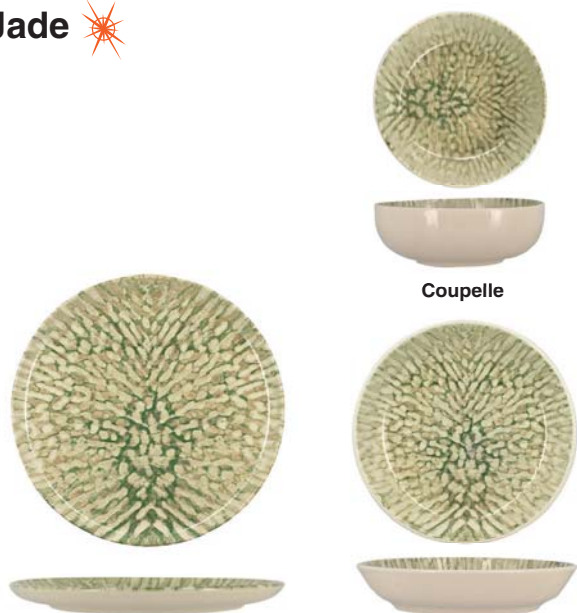

Coupelle

Plate

Creuse

Désignation	Code	Ccl	Φ x Ht cm	Sur.	Prix HT
Plate	32 05 897		20 x 2	12	2,55
	32 05 895		26 x 2,5	12	3,25
Creuse	32 05 896	60	20,5 x 4	12	2,95
Coupelle	32 05 898	60	16 x 5,5	12	2,95

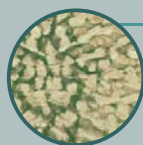

DÉCOR IMPRIMÉ

Un vert nuancé et tacheté, inspiré par la nature, pour une table tout en douceur.



Ambre

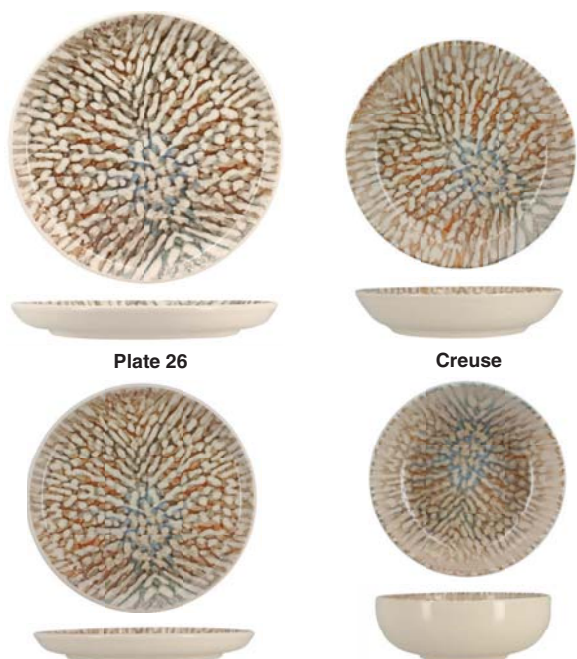

Plate 26

Creuse

Plate 20

Coupelle

Désignation	Code	Ccl	Φ x Ht cm	Sur.	Prix HT
Plate	32 05 267		20 x 2	12	2,55
	32 05 265		26 x 2,5	12	3,25
Creuse	32 05 266	60	20,5 x 4	12	2,95
Coupelle	32 05 268	60	16,5 x 5,5	12	2,95



Florali

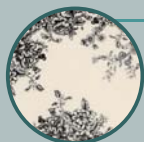

Plate Ø26



Plate Ø19,5

Désignation	Code	Φ x Ht cm	Sur.	Prix HT
Plate	32 05 482	19,5 x 2	12	2,55
	32 05 480	26 x 3	12	3,25



DÉCOR IMPRIMÉ

Décor floral décliné sur une assiette qui rappelle nos tables d'antan.



Creuse 90 cl



Bol 50 cl

Désignation	Code	Ccl	Φ x Ht cm	Sur.	Prix HT
Creuse	32 05 481	90	20,5 x 5,5	12	2,95
Bol	32 05 485	50	16 X 6,5	12	3,45

Faustine



Plate



Creuse

Désignation	Code	Ccl	Φ x Ht cm	Sur.	Prix HT
Plate	25 13 087		20 x 2	12	3,45
	25 13 085		26 x 3,5	12	4,35
Creuse	25 13 086	30	22 x 4	12	3,75



Faustine Rose



Plate

Creuse



Désignation	Code	Ccl	Φ x Ht cm	Sur.	Prix HT
Plate	25 13 162		20,5 x 2	6	3,45
	25 13 160		26 x 3,5	6	4,35
Creuse	25 13 161	30	22 x 4	6	3,75



DÉCOR D'ANTAN

Redonnez vie à vos tables avec nos magnifiques assiettes d'antan au décor fleuri.

Chaque pièce raconte une histoire, empreinte d'élégance et de douceur. Le style vintage, délicatement orné de motifs floraux, apporte une touche romantique et chaleureuse à chaque repas.



Résistance aux chocs et aux rayures



Charlotte



Plate 20

Plate 26

Creuse

Désignation	Code	Ccl	Φ x Ht cm	Sur.	Prix HT
Plate	25 13 132		20 x 2,3	6	2,95
	25 13 130		26 x 2,3	6	3,95
Creuse	25 13 131	30	22 x 3,4	6	3,55



Plate



Creuse



Plat rectangle



AUTHENTICITÉ

Élégante et naturelle, cette assiette sublime chaque moment de partage.

Son design raffiné s'adapte à toutes les ambiances, modernes ou classiques, tandis que son matériau, reconnu pour sa finesse et son authenticité, en fait un indispensable de la table.



Désignation	Code	Ccl	Φ x Ht cm	Sur.	Prix HT
Plate	25 13 396		21 x 2	12	3,90
	25 13 395		28 x 1,7	12	4,95
Creuse	25 13 397	38	16 x 4,5	12	2,95
	25 13 398	70	20 x 5	12	4,65
Plat rectangle	25 13 400		24 x 16 x 1,5	12	4,95
	25 13 401		32 x 12 x 1,5	12	4,95

Amatxi



Plate

Creuse



Pizza

Pâtes



INSPIRATION MOSAÏQUE

Apportez une touche d'élégance et d'exotisme à votre table avec la gamme Amatxi, inspirée des mosaïques orientales et méditerranéennes.

Son design raffiné et ses couleurs harmonieuses subliment toutes les occasions et s'adaptent à tous les styles de table.

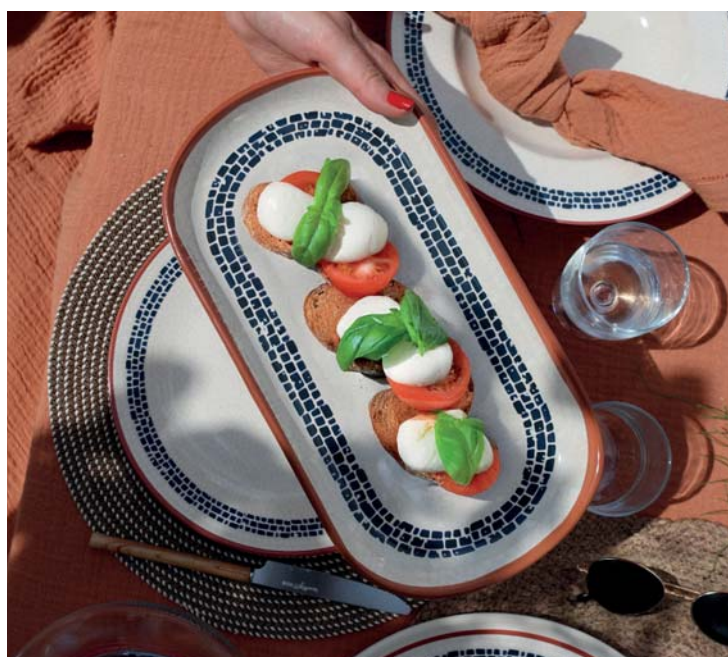

Ovale

Désignation	Code	Ccl	Φ x Ht cm	Sur.	Prix HT
Plate	25 13 452		20 x 2	12	2,85
	25 13 450		25 x 2,5	12	3,95
Creuse	25 13 451	70	21 x 4,5	24	3,30
Pizza	25 13 453		32 x 1,5	6	6,75
Pâtes	25 13 454		28 x 5	8	6,30
Ovale	25 13 455		26 x 12,5 x 3	6	4,05
	25 13 456		30 x 16 x 3	6	5,95

 New products
Nouveautés



Présentation

Code	Φ x Ht cm	Sur.	Prix HT
26 30 739	30,5 x 3,2	3	6,43



Plate

Code	Φ x Ht cm	Sur.	Prix HT
26 30 735	26,5 x 2,6	6	2,50
26 30 734	24 x 2	6	2,05
26 30 737	19 x 2	6	1,65
26 30 733	15 x 2	6	1,65



Creuse

Code	Ccl	Φ x Ht cm	Sur.	Prix HT
26 30 736	29	21,5 x 3,5	6	1,85



Bol

Code	Ccl	Φ x Ht cm	Sur.	Prix HT
26 30 740	60	14,5 x 8	6	2,65



Porcelaine Blanche



Saladier

Code	Ccl	Φ x Ht cm	Sur.	Prix HT
26 30 738	130	23 x 7	3	3,25



Assiette à Pâtes

Code	Ccl	Φ x Ht cm	Sur.	Prix HT
26 30 366	27/75	23,5 x 5,6	6	2,92
26 30 367	45/130	26,8 x 5,7	6	3,25



Assiette à Pizza

Code	Ccl	Φ x Ht cm	Sur.	Prix HT
26 30 365		30 x 2,6	12	3,85

Metropolitan



Plate

Paire tasse
(tasse et soucoupe)

Calotte



Désignation	Code	Ccl	Φ x Ht cm	Sur.	Prix HT
Plate	26 30 863		27 x 2,9	6	2,75
	26 30 864		21 x 2,4	6	1,95
Calotte	26 30 865	70	20 x 4	6	2,25
	26 30 866	110	26,5 x 4	6	3,97
Paire tasse (Boîte de 6)	26 30 867	10	12,5 x 5,5	6	13,50
	26 30 868	20	15 x 7,5	6	16,50



Porcelaine Blanche



Alaska



Rectangle



Plate carrée



Creuse / saladier

Paire tasse 22 cl
(tasse et soucoupe)

Désignation	Code	Ccl	Φ x Ht cm	Sur.	Prix HT
Rectangle	26 30 375		30,5 x 19,5 x 3	12	5,85
Plate carrée	26 30 370		26,5 x 26,5 x 2,8	24	3,25
	26 30 372		20 x 20 x 2,4	24	2,05
Saladier	26 30 374	90	23,5 x 7	12	3,95
Creuse	26 30 371	50	18 x 5,4	24	2,95
Tasse + Soucoupe	26 30 373	22	7,5-9 x 8,2 14,5	24	3,67

Ambassador



Plate

Creuse

Pain

Tasses empilable et soucoupe

Désignation	Code	Ccl	Φ x Ht cm	Sur.	Prix HT
Plate	26 15 071		27 x 2,2	6	4,95
	26 15 072		25 x 2	6	4,31
	26 15 074		20 x 1,8	6	3,63
Creuse	26 15 073	25	23 x 3,4	6	4,06
Pain	26 15 075		16 x 1,8	6	3,13
Tasse	26 15 080	10	6-7,8 x 5	12	2,01
Soucoupe	26 15 081		12,5 x 1,6	6	1,38
Tasse	26 15 084	20	8-10,5 x 6,5	12	3,43
Soucoupe	26 15 085		16 x 1,8	6	1,91



Porcelaine Blanche Hôtelière



Texture et motif inaltérable



Polo



Plate

Creuse

Désignation	Code	Ccl	Φ x Ht cm	Sur.	Prix HT
Plate	26 15 650		31,5 x 3,2	24	10,40
	26 15 651		27,5 x 2,6	24	4,40
	26 15 652		25,5 x 2,6	24	3,55
	26 15 653		20 x 2,4	24	3,40
Creuse	26 15 654	30	23 x 3,8	24	3,60
Pain	26 15 655		16 x 2,2	24	2,70

Carré Hôtel



Plate carrée

Code	L x l x Ht cm	Sur.	Prix HT
26 15 443	30 x 30 x 3,1	4	11,31
26 15 439	27 x 27 x 2,6	6	7,27
26 15 440	25 x 25 x 2,8	6	5,55
26 15 442	19 x 19 x 2,6	6	5,10



Creuse carrée

Code	Ccl	Φ x Ht cm	Sur.	Prix HT
26 15 441	65	20 x 20 x 4,4	6	5,11
Pain carré				
26 15 730		16 x 16 x 2,5	6	3,50
26 15 732		14 x 14 x 2,5	6	2,85
26 15 731		12 x 12 x 2,5	6	2,55



A. Coupelle

Code	Ccl	Φ x Ht cm	Sur.	Prix HT
26 15 729	40	14 x 4,5	6	3,95
26 15 728	30	12 x 4,5	12	3,75
26 15 454	17	10 x 4,5	6	1,99



B. Saladier

Code	Ccl	Φ x Ht cm	Sur.	Prix HT
26 15 453	150	22 x 8	4	9,79
26 15 448	70	16 x 6,4	6	5,12



Plat à entrecôte rectangle

Code	L x l x Ht cm	Sur.	Prix HT
26 15 452	33 x 18,5 x 2,4	6	12,70
Plat rectangle			
26 15 449	28 x 15 x 2,4	6	6,18
26 15 450	23,5 x 11 x 2,4	6	5,15
26 15 451	15 x 13 x 2,4	6	4,25



Tasse à café



Tasse déjeuner

Code	Ccl	Φ x Ht cm	Sur.	Prix HT
26 15 444	9	5,6-7,8 x 5,8	6	3,05
scp 26 15 445		13,6 x 13,6 x 1,9	6	2,72
26 15 446	20	7,5-9,7 x 6,2	6	3,35
scp 26 15 447		15,1 x 15,1 x 2,1	6	3,07

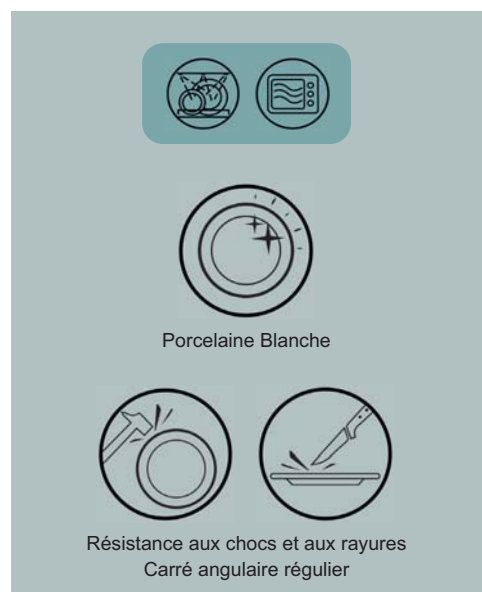

Classic Filet Or



Plate Ø27



Plate Ø16



Creuse



Tasse et soucoupe

Désignation	Code	Ccl	Φ x Ht cm	Sur.	Prix HT
Plate	26 15 560		27 x 1,9	6	4,46
	26 15 562		20,5 x 1,5	6	4,15
	26 15 566		16 x 1,3	6	3,73

Désignation	Code	Ccl	Φ x Ht cm	Sur.	Prix HT
Creuse	26 15 561	25	22,5 x 3,2	6	4,36
Tasse	26 15 568	16	7,2-9,2 x 6,3	12	3,41
Soucoupe	26 15 569		12,8 x 2	12	1,83



Carbone



Plate



Creuse

Désignation	Code	Φ x Ht cm	Sur.	Prix HT
Plate	26 30 870	27 x 2,2	6	2,95
	26 30 872	19,5 x 1,8	6	2,25
Creuse	26 30 871	20,5 x 3,7	6	2,50

OMEGA

New collection by OGO



Porcelaine blanche de qualité hôtelière.

OGO
LIVING



Wersal



Plate



Tasse à Thé 20 cl
ronde et soucoupe

Désignation	Code	Ccl	Ø x Ht cm	Sur.	Prix HT
Plate	26 91 260		30,5 x 2,5	6	12,50
	26 91 261		27 x 2,1	6	5,95
	26 91 259		21 x 1,8	6	4,80
	26 91 262		19 x 1,6	6	4,50
Creuse	26 91 263	25	22,5 x 3,6	6	4,95
Tasse	26 91 271	20	9,3/12 x 5,6	24	3,86
Soucoupe	26 91 270		14,5 x 1,8	24	2,43

Roma



Porcelaine Blanche



Grande aile



Plate



Creuse



Désignation	Code	Ccl	Ø x Ht cm	Sur.	Prix HT
Plate	26 91 211		27 x 2,3	6	5,77
	26 91 208		24 x 2,1	6	4,97
	26 91 209		21 x 1,9	6	4,84
	26 91 212		19 x 1,7	6	4,06
Gde aile	26 91 310		27 x 3,8	6	10,95
Creuse	26 91 213		22,5 x 3,4	6	4,51

Martelé



Présentation

Plate



Creuse



Paire tasse café
(tasse et soucoupe)



Désignation	Code	Ccl	Φ x Ht cm	Sur.	Prix HT
Présentation	26 90 342		29 x 1,8	6	9,71
Plate	26 90 341		27 x 1,8	6	6,49
	26 90 340		23 x 1,8	6	5,87
Creuse	26 90 343	25	23 x 4,2	6	5,62
Paire tasse	26 90 346	10	6-8 x 6	6	6,14
Soucoupe			12 x 1,3		

Risotto

ÉLÉGANT ET RAFFINÉ

Une assiette pensée pour accueillir la douceur d'un risotto crémeux, entre finesse des formes et élégance des matières.

Conçues pour sublimer les présentations, nos assiettes à risotto allient design soigné et praticité au service des chefs



Porcelaine Blanche



Galaxy

Roma



Martelé



Lodge



Kaszub

Désignation	Code	Ccl	Φ x Ht cm	Sur.	Prix HT
Galaxy	26 15 634	30	28 x 4	6	7,55
	26 15 633	24	24 x 4	6	5,52
Roma	26 91 310	35	27 x 3,8	6	10,95

Désignation	Code	Ccl	Φ x Ht cm	Sur.	Prix HT
Martelé	26 90 343	25	23 x 4,2	6	5,62
Lodge	26 91 309	90	23 x 9,5	6	8,60
Kaszub	26 91 490	55	26 x 9	6	5,35

Pasta



Pasta



Bol Pasta empilable

Désignation	Code	Ccl	Φ x Ht cm	Sur.	Prix HT
Bol Pasta	26 30 366	27-75	23,5 x 5,6	6	2,92
	26 30 367	45-130	26,8 x 5,7	6	3,25
Bol Pasta empilable	26 91 490	55-145	26 x 9	6	5,35

Les inclinés

novastyl



Bols Inclina



Lodge



Rita

Désignation	Code	Ccl	Φ x Ht cm	Sur.	Prix HT
Inclina	26 30 028	60	19 x 6-9	6	4,95
Lodge	26 91 309	90	23 x 7-9,5	6	8,60
	26 91 306	20	14 x 4-6	6	3,80
Rita	26 91 312	80	30 x 7	6	10,25

Pizza



Assiette Pizza

Pizza Bianca

Désignation	Code	Φ x Ht cm	Sur.	Prix HT
Pizza	26 30 365	30 x 2,6	3	3,85
Bianca	26 45 542	31 x 1,7	6	6,15

Assiette à compartiments



Assiette à fondue

Désignation	Code	Φ x Ht cm	Sur.	Prix HT
Fondue	26 45 519	22,5 x 23,5	4	6,95

Creuses coupes



Metropolitan

Désignation	Code	Ccl	Φ x Ht cm	Sur.	Prix HT
Metropolitan	26 30 865	70	21 x 4	6	2,25
	26 30 866	110	26,5 x 4	6	3,97



Saladiers



Résistance aux chocs et aux rayures



Couscous aile renforcée

Code	Ccl	Φ x Ht cm	Sur.	Prix HT
26 91 480	95	26 x 5	6	6,25
26 91 479	70	23 x 4,2	6	4,85
26 91 478	50	20 x 4	12	3,75



Carré saladier

Code	Ccl	Φ x Ht cm	Sur.	Prix HT
26 15 453	150	22 x 8	4	9,50
26 15 448	70	16 x 6,4	6	4,95
26 15 729	52	14 x 4,5	6	3,95



Carré coupelle

Code	Ccl	Φ x Ht cm	Sur.	Prix HT
26 15 728	32	12 x 4,5	12	3,75
26 15 454	17	10 x 4,5	6	1,99



Alaska

Code	Ccl	Φ x Ht cm	Sur.	Prix HT
26 30 374	90	23,5 x 7	3	3,95
26 30 371	50	18 x 5,4	6	2,95



Pasta coupe

Code	Φ x Ht cm	Sur.	Prix HT
26 15 551	26 x 5,5	6	5,55
26 15 552	30 x 6,5	6	6,32



White

Code	Ccl	Φ x Ht cm	Sur.	Prix HT
26 30 738	130	24 x 8,5	3	3,25

Carpaccio

novastyl



Carpaccio

Désignation	Code	L x l x Ht cm	Sur.	Prix HT
Carpaccio	26 45 561	35 x 25 x 2,8	6	7,88
	26 45 560	31 x 21 x 2,5	6	4,95
	26 45 559	25 x 18 x 2,5	6	4,39



Mariott

Désignation	Code	L x l x Ht cm	Sur.	Prix HT
Carpaccio	26 15 790	39,5 x 28 x 3,5	3	13,23

Assiette à steak



Steak grès

Désignation	Code	L x l x Ht cm	Sur.	Prix HT
Steak	32 05 225	30,5 x 24 x 3	6	5,75



Porcelaine Blanche



Spécialité



Rita forme coupe

Désignation	Code	L x l x Ht cm	Sur.	Prix HT
Rita	26 45 506	33 x 25,5 x 3,2	6	3,85



Burger Time

Désignation	Code	L x l x Ht cm	Sur.	Prix HT
Burger Time	26 15 779	29,5 x 26,5 x 3	6	5,45



Steakhouse

Désignation	Code	L x l x Ht cm	Sur.	Prix HT
Steakhouse	26 15 786	29,5 x 26 x 3,9	6	5,45

Oslo



Plate

Code	N°	Φ x Ht cm	Sur.	Prix HT
26 95 001	N°7	18 x 2	48	3,51
26 95 002	N°4	22 x 2	24	4,46
26 95 003	N°3	24 x 2	24	4,76



Creuse

Code	N°	Φ x Ht cm	Sur.	Prix HT
26 95 004	N°10	13 x 2	96	2,76
26 95 005	N°9	15 x 2	72	2,76
26 95 007	N°4	22 x 2	24	4,46



Tasse à café seule



Tasse à thé seule



Tasse déjeuner seule



3 Comptoirs



2 Coupelles



2 Raviers



Porcelaine Blanche



Bords renforcés
Parfaitement empilable



2 Bols Oslo



Bol Arcole

Code	Ccl	Φ x Ht cm	Sur.	Prix HT
26 95 020	9	5,5 x 6	48	2,78
26 95 021		12,3 x 2	12	2,96
26 95 022	15	8 x 5	48	3,23
26 95 026	28	10 x 6,5	36	3,91



2 Ramequins



Plat sabot

Code	Ccl	Φ x Ht cm	Sur.	Prix HT
26 95 086	11	8,4 x 5	48	2,61
26 95 087	19	10 x 5	48	2,93
26 95 071	44	19 x 11 x 4	36	4,38

Code	Ccl	Φ x Ht cm	Sur.	Prix HT
26 95 055	15	12 x 3,5	48	2,33
26 95 056	22,5	13,3 x 4,5	48	2,70
26 95 057	37	16 x 4,5	36	3,26
26 95 062	8	10 x 2,5	48	1,76
26 95 063	16	13 x 3	48	2,63
26 95 069	20	11 x 11 x 3,5	72	2,45
26 95 070	25	15 x 9 x 3,5	72	2,58

Code	Ccl	Φ x Ht cm	Sur.	Prix HT
26 95 014	40	13,8 x 5,5	36	4,64
26 95 015	60	16 x 6	36	5,51
26 95 035	40	13 x 7	36	3,43



Autonomy

Cette gamme vise à faciliter les repas des personnes âgées en perte d'indépendance grâce à des assiettes fonctionnelles et adaptées



Chope



Filet Rouge



Blanc



Filet Bleu

Désignation	Code	Φ x Ht cm	Sur.	Prix HT																			
Autonomy Blanc	75 50 880	19 x 2,7	12	4,80																			
	75 50 881	23,5 x 2,7	12	5,50																			
Autonomy filet Bleu	75 50 885	19 x 2,7	12	6,35																			
	75 50 886	23,5 x 2,7	12	7,25																			
Autonomy filet Rouge	75 50 890	19 x 2,7	12	6,35																			
	75 50 891	23,5 x 2,7	12 </tr <tr> <td>Autonomy Creuse Blanc</td> <td>75 50 882</td> <td>23 x 4</td> <td>12</td> <td>5,50</td> </tr> <tr> <td>Autonomy Creuse Bleu</td> <td>75 50 887</td> <td>23 x 4</td> <td>12</td> <td>7,25</td> </tr> <tr> <td>Autonomy Creuse Rouge</td> <td>75 50 892</td> <td>23 x 4</td> <td>12</td> <td>7,25</td> </tr> <tr> <td>Gobelets Autonomy</td> <td>75 07 470</td> <td>9,2 x 11,5</td> <td>12</td> <td>2,46</td> </tr>	Autonomy Creuse Blanc	75 50 882	23 x 4	12	5,50	Autonomy Creuse Bleu	75 50 887	23 x 4	12	7,25	Autonomy Creuse Rouge	75 50 892	23 x 4	12	7,25	Gobelets Autonomy	75 07 470	9,2 x 11,5	12	2,46
Autonomy Creuse Blanc	75 50 882	23 x 4	12	5,50																			
Autonomy Creuse Bleu	75 50 887	23 x 4	12	7,25																			
Autonomy Creuse Rouge	75 50 892	23 x 4	12	7,25																			
Gobelets Autonomy	75 07 470	9,2 x 11,5	12	2,46																			

Heat System



Plate Blanche



Plate Blanche à 2 compartiments

Désignation	Code	Ccl	Φ x Ht cm	Sur.	Prix HT
Blanche	75 50 900		23 x 2,5	24	9,29
Blanc. 2 compartiments	75 50 901		23 x 2,5	24	10,21



Bol



Bol à potage

Désignation	Code	Ccl	Φ x Ht cm	Sur.	Prix HT
Bol	75 50 052	62	12 x 6,2	24	2,88
Bol Opal blanc	75 50 527	50	12,7-16,3 x 6,8	24	4,45



Empilable, robuste et compatible lave-vaisselle



Assiette carrée Restaurant

Désignation	Code	Φ x Ht cm	Sur.	Prix HT
Assiette carrée Restau.	75 50 057	20 x 20 x 3	12	6,69

Nova Aquitania



Bol 230 gr / 50 cl



Creuse 56 cl



Plate 290 gr

Désignation	Coloris	Code	Ccl	Φ x Ht cm	Sur.	Prix HT
Plate	Blanc	75 50 368		22,5 x 1,9	24	1,44
Dessert	Blanc	75 50 369		15,5 x 1,4	24	1,31
Creuse	Blanc	75 50 384	56	22,5 x 2,6	24	1,46
Coupelle	Blanc	75 50 385	20	13 x 3,5	36	1,31
Bol	Blanc	75 50 386	50	13,2 x 6,8	36	1,68

Assiettes compartimentées



Assiette ronde 2 parties



Assiette ronde 3 parties

Désignation	Code	Ccl	Φ x Ht cm	Sur.	Prix HT
Assiette ronde 2 parties	75 50 053		23	12	11,32
Assiette 3 compartiment	75 50 302		23 x 2,5	12	11,32



New products
Nouveautés

Restaurant Uni



Restaurant Filet Rouge Bordeaux

Opal
ARCOROC



Plate



Creuse 69 cl



Assiette à steak



Tasse empilable Restaurant et sous-tasse



Plate



Creuse

Désignation	Code	Ccl	Φ x Ht cm	Sur.	Prix HT
Plate	75 50 062		23,5 x 2,6	24	5,73
Dessert	75 50 067		19,5 x 2,2	24	5,19
	75 50 064		15,5 x 1,8	24	4,06
Creuse	75 50 069	69	22,5 x 3,5	24	5,73
Bol empilable	75 50 098	51	13,2 x 7,4	36	4,65
Saladier empilable 12,5	75 50 088	31,5	12 x 4,7	36	3,91

Désignation	Code	Ccl	Φ x Ht cm	Sur.	Prix HT
Assiette	75 50 002		25,4 x 2,5	12	5,03
	75 50 003		23,5 x 2,6	24	4,65
	75 50 004		22,5 x 3,5	24	4,65
	75 50 008		19,5 x 2,2	24	4,06
	75 50 005		15,5 x 1,8	24	3,15
Creuse	75 50 010	69	22,5 x 3,5	24	4,65
Assiette à steak	75 50 013		30 x 26	6	6,17
Tasse	75 50 032	25	8,5 x 7	36	2,60
	75 50 031	22	7,8 x 7,4	48	2,47
	75 50 029	19	7,8 x 6,4	48	2,40
	75 50 027	13	6,9 x 5,7	48	2,40
	75 50 025	8	6 x 5	48	1,89
Sous-tasse	75 50 033		15,3 x 2,1	36	2,07
	75 50 030		14 x 1,9	48	1,86
	75 50 028		13 x 1,8	48	1,62
	75 50 026		11,2 x 1,6	48	1,52

Brush



Couppelles
11 cl empilable

Saladiers 31,5 cl



Assiettes creuses 63 cl

Assiettes plates

Bols empilables 51 cl

Ravier

Désignation	Φ x Ht	Vert	Jaune	Orange	Cherry	Blue jean's	Sur.	Prix HT
Assiette	23,5 x 2,6	75 51 235	75 51 245	75 51 225	75 51 541	75 51 521	6/24	6,89
	19,5 x 2,2	75 51 237	75 51 247	75 51 227	75 51 542	75 51 522	6/24	6,10
	15,5 x 1,8	75 51 236	75 51 246	75 51 226	75 51 543	75 51 523	6/24	5,54
	22,5 x 3,5	75 51 238	75 51 248	75 51 228	75 51 544	75 51 524	6/24	6,89
Creuse 63		75 51 239			75 51 545	75 51 525	6/36	4,43
Couppelle empil. 11 cl	12 x 2,6	75 51 239			75 51 545	75 51 525	6/36	4,43
Saladier 31,5 cl	12 x 4,7	75 51 244	75 51 254		75 51 547	75 51 527	6/36	4,43
Bol 51 cl	13,2 x 7,4	75 51 240	75 51 250	75 51 230	75 51 548	75 51 528	6/36	5,52
Ravier carré 20 cl	11 x 11 x 3,6				75 51 546	75 51 526	6/24	7,19

Bocks 25cl, tasses 19cl, sous tasse 140 et autres couleurs, nous consulter.



MULTI RÉSISTANCES CHOCS, RAYURES, LAVAGES

- Jusqu'à 3 fois plus résistante aux chocs que les autres matières du marché.
- Résistance durable aux rayures de couteaux.
- Excellente résistance aux lavages de la surface et des décors après 2000 lavages industriels.



SECURITE : 0% porosité, 0% bactéries.

GESTION DE LA TEMPERATURE : MAINTIEN DE LA CHALEUR, SECURITE MICRO-ONDE
- Un maintien de la température aussi efficace que les autres matériaux du marché.
- Se manipule sans risque de brûlure après un passage au micro-onde.

PRESERVATION DE L'ENVIRONNEMENT :
- 100% verre, 100% recyclable : matière respectueuse de l'environnement.



Everydays Restaurant Slim



Plate



Creuse

Désignation	Code	Ccl	Φ x Ht cm	Sur.	Prix HT
Plate	75 45 930		26,5 x 2,1	24	1,85
	75 45 931		24,5 x 2,1	24	1,50
	75 45 933		19,5 x 1,5	24	1,45
Creuse	75 45 932	50	22,5 x 3	24	1,50

Evolutions Black



Evolutions Coupe White



Plate coupe



Coupelle 40 cl



Coupelle 60 cl



Assiette calotte 78 cl

Désignation	Code	Ccl	Φ x Ht cm	Sur.	Prix HT
Plate coupe	75 50 350		27 x 1,8	24	2,13
	75 50 351		25 x 1,7	24	1,96
	75 50 353		19 x 1,7	24	1,84
Coupelle	75 50 354	40	12,5 x 5,5	36	1,84
	75 50 733	60	17 x 4	12	2,29
Calotte	75 50 352	78	20 x 4,2	24	1,98



Résistance aux chocs et aux rayures légères mais avec les qualités de solidité de l'opal.



Plate



Rectangle



Creuse



Assiette à steak

Désignation	Code	Ccl	Φ x Ht cm	Sur.	Prix HT
Plate	75 50 375		27 x 1,8	24	2,27
	75 50 374		25 x 1,7	24	2,09
	75 50 373		19 x 1,7	24	1,98
Pizza	75 50 378		32 x 2,4	12	4,83
Rectangle	75 50 376		28 x 23 x 2,2	12	3,01
Creuse	75 50 372	78	20 x 4,2	24	2,09
Creuse Couscous	75 50 371	120	26 x 4,5	12	4,83
Pasta	75 50 377	115	28,5 x 4,5	12	4,83
Steak	75 50 370		30 x 3	12	4,83

Stairo



Opal
SHARING MATTER!
ARCOROC



Plate



Bol

Désignation	Code	Ccl	Φ x Ht cm	Sur.	Prix HT
Plate	75 50 611		27 x 2,5	24	1,86
	75 50 612		25 x 2,3	24	1,51
	75 50 615		23,5 x 2,1	24	1,41
	75 50 614		19 x 1,9	24	1,39
Creuse	75 50 613		23,6 x 3,2	24	1,51
Bol	75 50 619	50	13,2 x 6,8	36	1,96

Les Bols



A. Uni blanc 48 cl



B. Ebro 50 cl



C. Régithermie 40 cl



D. Restaurant uni 52 cl



E. Potage anses 50 cl



F. Consommé anses
31 cl

Désignation	Code	Ccl	Φ x Ht cm	Sur.	Prix HT
A. Uni Blanc	75 50 525	48	13,2 x 6,8	36	1,84
B. Ebro	16 60 004	50	14 x 7	36	1,68
C. Régithermie	75 50 052	40	12 x 6,2	24	2,88
D. Restaurant	75 50 050	52	13,2 x 7,4	36	2,22
E. Potage anses	75 50 527	50	16,3-12,7 x 6,9	24	4,45
F. Consommé	75 50 051	31	10,2 x 5,8	24	3,74

Feston



Feston caracas

Désignation	Code	Φ x Ht cm	Sur.	Prix HT
Plate	75 50 555	27,3 x 2,3	6	1,85
	75 50 554	25 x 2,2	6	1,50
	75 50 556	23 x 2,1	6	1,50
	75 50 558	19 x 1,9	6	1,40
Creuse	75 50 557	21 x 3	6	1,50
Plat	75 50 559	30 x 2,2	6	5,60
Plat creux	75 50 560	28 x 4,6	4	5,65
Plat ovale	75 50 561	33 x 25	6	5,60
Saladier	75 50 564	24 x 10	6	4,45
	75 50 563	12 x 5,2	6	1,40

Cylindriques empilables



Tasse cylindrique
empilable



Bock empilable

Désignation	Code	Ccl	Φ x Ht cm	Sur.	Prix HT
Tasse	75 50 516	28	11,7 x 6,1	24	3,02
	75 50 514	22	10,3 x 6,5	24	2,25
	75 50 512	14	9,8 x 4,9	24	2,02
Sous-tasse	75 50 517		16 x 2,1	48	2,65
	75 50 515		14 x 1,8	72	2,45
	75 50 026		11 x 1,6	48	1,52
Bock	75 50 528	29	7,9 x 9	36	1,70
	75 50 529	25	7,2 x 9	36	2,40

Complément Opal



Compotier



Multi-usage



Raviers empilable



Saladier empilable

Désignation	Code	Ccl	Φ x Ht cm	Sur.	Prix HT
Compotier	75 50 041	27,5	16 x 3,6	36	3,32
	75 50 040	11	12 x 2,6	36	2,62
Multi-usage	75 50 042	52	16 x 5,1	24	3,36
Ravier	75 50 043	28	14 x 9 x 3,5	24	4,65
	75 50 044	25	11 x 11 x 3,6	24	4,47
Saladier	75 50 023	48	14 x 14 x 5,2	36	4,08
	75 50 038	31,5	12,1 x 4,7	36	2,62



Plat de présentation  *novastyl*



Plat de service avec cloche

Désignation	Code	Φ x Ht cm	Sur.	Prix HT
Plat service	16 18 826	31,5 x 18,5	4	14,00

Lys



Plate

Calotte

Désignation	Code	Φ x Ht cm	Sur.	Prix HT
Plate	75 28 001	23 x 2,2	24	2,04
Calotte	75 28 004	21 x 4,7	36	1,80



Plat à tarte

Plat à tarte + cloche

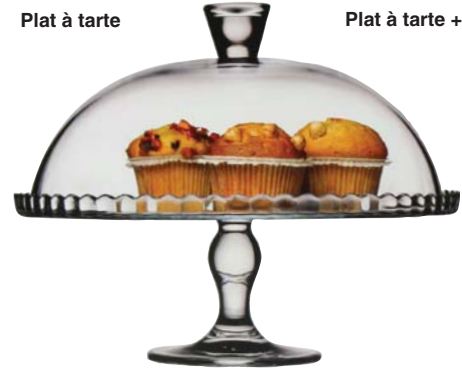

Plat sur pied + cloche

Désignation	Code	Φ x Ht cm	Sur.	Prix HT
Plat sur pied	16 13 280	33 x 29	2	18,52
Plat + cloche	16 13 281	32 x 18	2	13,55
Plat	16 13 282	32 x 2	10	5,60

Génération



Plate

Creuse

Désignation	Code	Φ x Ht cm	Sur.	Prix HT
Plate	16 13 242	27 x 2	24	1,65
Dessert	16 13 244	19 x 1,3	24	1,25
Creuse	16 13 243	21 x 3,5	24	1,50

Picardie / Paris



Plate

Creuse

Désignation	Code	Φ x Ht cm	Sur.	Prix HT
Plate	75 28 200	23 x 1,6	48	1,74
Creuse	75 28 201	23 x 3,5	48	1,74



Saladiers en verre



Saladier cocoon

Désignation	Code	Ccl	Φ x Ht cm	Sur.	Prix HT
Saladier cocoon	75 16 072	360	24 x 13,2	4	7,25
	75 16 070	150	18 x 9,8	6	5,90
	75 16 068	41	12 x 6,7	36	2,30
	75 16 066	4,5	6 x 3,3	36	1,45



Saladier empilable

Désignation	Code	Ccl	Φ x Ht cm	Sur.	Prix HT
Saladier empil.	75 16 020	600	29 x 13,3	6	10,09
	75 16 019	430	26 x 1,9	6	7,83
	75 16 018	290	23 x 10,5	6	5,26
	75 16 017	190	20 x 9,2	6	4,11
	75 16 016	110	17 x 7,8	24	2,27
	75 16 015	62,5	14 x 6,5	36	1,98
	75 16 014	36,5	12 x 5,5	36	1,28
	75 16 013	24	10 x 4,9	36	1,04
	75 16 012	15	9 x 4,1	36	1,01
	75 16 011	7,5	7 x 3,5	36	0,90
	75 16 010	3,2	6 x 2,7	36	0,83



Mister chef

Désignation	Code	Ccl	Φ x Ht cm	Sur.	Prix HT
Mister chef	13 10 577	395	30 x 12,7	6	14,90
	13 10 576	260	26 x 11,2	6	9,96
	13 10 575	162	22 x 9,7	6	7,87
	13 10 574	75	17 x 7,5	12	5,04
	13 10 573	37	14 x 6,1	24	3,08
	13 10 572	18,2	11 x 4,8	24	2,35
	13 10 570	8,5	9 x 3,7	36	1,75



Saladier Chef

Désignation	Code	Ccl	Φ x Ht cm	Sur.	Prix HT
Empilable	16 11 878	34	12 x 5,5	48	1,30
	16 11 879	59,5	14 x 6,5	36	1,73
	16 11 880	110	17 x 7,5	24	2,52
	16 11 881	170	20 x 9,5	12	4,38
	16 11 882	250	23 x 11	6	5,10
	16 11 883	390	26 x 11	6	7,50
	16 11 884	550	30 x 12,5	2	11,88



Inox



novastyl



Fond extérieur antidérapant en silicone noir.



Saladier boule

Désignation	Code	Ccl	Φ x Ht cm	Sur.	Prix HT
Saladier boule	46 15 298	500	29 x 13,5	6	7,95
	46 15 297	370	24 x 12	6	6,01
	46 15 296	150	19 x 9,5	6	3,85
	46 15 295	75	15 x 8	6	2,45



Corbeille à pain en inox

Désignation	Code	L x l x Ht cm	Sur.	Prix HT
Corbeille	46 15 345	18 x 8	6	3,67
	46 15 346	20 x 10,5	6	4,25

Saladier inox antidérapant

Désignation	Code	Ccl	Φ x Ht cm	Sur.	Prix HT
Saladier inox	46 15 340	130	18 x 9	12	3,85
	46 15 341	250	22 x 10,4	12	4,85
	46 15 342	370	25,5 x 12	12	6,85



Plat gratin inox ovale renforcé



Légumier renforcé

Désignation	Code	Ccl	Φ x Ht cm	Sur.	Prix HT
Plat gratin	47 37 122		30 x 18	6	14,82
	47 37 121		25 x 15	6	12,21
	47 37 124		38 x 23	6	20,19
	47 37 114	265	34 x 27 x 6,5	6	20,07
	47 37 112	155	28 x 22 x 5,5	6	15,06
	47 37 111	75	22 x 18 x 4,5	6	10,20



Panier inox



Désignation	Code	Ccl	L x l x Ht cm	Sur.	Prix HT
Panier inox	37 21 270		19-10 x 8,5	6	6,95

Rivage - Mélangé



Plate



Coupelle

Désignation	Ccl	Code	Φ x Ht cm	Sur.	Prix HT
Plate		63 17 705	27 x 1,3	6	4,55
Dessert		63 17 706	21 x 1,3	6	3,65
Coupelle	65	63 17 707	16 x 4,8	6	2,95

Kuwae - Mélangé

novastyl



Plate



Coupelle

Désignation	Couleurs	Ccl	Code	Φ x Ht cm	Sur.	Prix HT
Plate	Vert		63 17 800	27,5 x 2	6	4,55
	Bleu		63 17 803	27,5 x 2	6	4,55
	Jaune		63 17 835	27,5 x 2	6	4,55
Coupelle	Vert	65	63 17 799	16 x 6,2	6	2,95
	Bleu	65	63 17 806	16 x 6,2	6	2,95
	Jaune	65	63 17 837	16 x 6,2	6	2,95

Couvertes



Cocotte ronde avec couvercle



Tajine

Désignation	Code	Cgr	L x l x Ht cm	Sur.	Prix HT
Cocotte ronde	75 41 429	100	20 x 12,3	1	13,55
Tajine	29 40 105		20 x 18	1	8,05

Terrines



Terrine foie gras



Terrines rectangulaires

Désignation	Code	Cgr	L x l x Ht cm	Sur.	Prix HT
Terrine Foie gras	29 40 460	1000	18,5 x 13 x 9	6	8,95
	29 40 029	600	17,5 x 13 x 7	6	5,35
	29 40 027	400	15 x 11 x 7	6	4,35
	29 40 026	200	11 x 8 x 5	6	3,35
Terrine Restangle	29 40 455	600	24,5 x 10,5 x 8	8	10,95

Escargot - Huître



Porcelaine



Inox

Plat à escargot 6 trous



Porcelaine



Inox

Plat à escargot 12 trous

Désignation	Code	Φ x Ht cm	Sur.	Prix HT
6 trous				
Porcelaine	29 40 034	16-18 x 2,5	6	2,80
6 x plats inox	46 15 204	15,5-19 x 1,6	6	10,29
12 trous				
Porcelaine	26 30 801	22-20 x 2,5	6	4,65
6 x plats inox	46 15 205	21-25,5 x 1,8	6	15,80



Pince Escargot



Huître Bourget



Fourchette escargot Bourget



Couteau huître bleu



Fourchette escargot Valmy



Huître Valmy



Couteau huître noir

Désignation	Code	L cm	Sur.	Prix HT
Pince escargot	47 10 448	15,5	12	4,12
Bourget	47 10 445	13	12	0,51
Valmy fourchette escargot	48 35 987	13	12	0,46
Valmy fourchette huître	48 35 986	13	12	0,32
Bourget	47 10 449	13	12	0,51
Couteau huître bleu	50 50 844	15	6	8,17
Couteau huître noir	47 10 453	15	12	2,05

Les Coquetiers

Coquetier grès bicolore
(6 coloris assortis)Coquetier grès poule
(3 coloris assortis)

Coquetier



Soupière tête de lion

Coquille Saint
Jacques blanc

Moule à flan blanc

Désignation	Code	Ccl	Φ x Ht cm	Sur.	Prix HT
Grès bicolore	24 25 740	5	10 x 5	12	2,15
Grès poule	30 20 837		5,3 x 6,5	12	1,55
Coquetier	26 30 107	5	4,7 x 6,8	12	0,95

Désignation	Code	Ccl	Φ x Ht cm	Sur.	Prix HT
Coquille blanc	26 30 108	20	14 x 13 x 3,5	6	2,50
Soupières	29 40 073	250	23,5 x 13	1	10,50
Tête de lion	29 40 074	160	20,5 x 12,8	8	10,73
	26 30 110	45	11 x 8,5	6	2,91
	29 40 002	10	6 x 5	12	2,45
Moule flan blanc	29 40 096	10	13,5 x 3,5	6	2,65



Les individuels



Compotier haut empilable

Code	Ccl	Φ x Ht cm	Sur.	Prix HT
29 40 247	37	15,5 x 4,4	12	2,96
29 40 246	22,5	13 x 4	12	2,06
29 40 245	15	12 x 3,5	12	1,78



Assiette à salade empilable

Code	Ccl	Φ x Ht cm	Sur.	Prix HT
29 40 025	95	18 x 5,5	6	4,75



Plat rond avec anses Optiva

Code	Ccl	Φ x Ht cm	Sur.	Prix HT
26 32 824	25	15 x 3,7	12	7,39
26 32 822	45	21 x 17 x 3,8	12	7,81
26 32 823	65	20 x 4,5	12	11,11



Assiette Marjolaine 'Welsh'

Code	Ccl	L x l x Ht cm	Sur.	Prix HT
33 56 060	65	19 x 25 x 4,8	6	4,25



Plat ovale à oreilles

Code	Ccl	L x l x Ht cm	Sur.	Prix HT
29 40 007	35	26 x 14 x 4,8	6	4,85



Plat léger à oreilles

Code	Ccl	Φ x Ht cm	Sur.	Prix HT
29 40 044	12	17,5 x 14 x 2,8	8	2,95
29 40 045	9	15,5 x 12,7 x 2,8	6	2,55
29 40 035	7	7-9 x 1,7	20	0,99



Gratin ovale empilable

Code	Ccl	L x l x Ht cm	Sur.	Prix HT
29 40 241	90	23 x 16 x 5	6	4,05
29 40 031	45	19 x 12 x 4	6	2,90



Ravier rectangle empilable

Code	Ccl	L x l x Ht cm	Sur.	Prix HT
29 40 242	60	22 x 16 x 4	6	4,05
29 40 240	45	19 x 13 x 4	6	3,35
29 40 032	30	14 x 9 x 4	6	2,15



Ravier carré empilable

Code	Ccl	L x l x Ht cm	Sur.	Prix HT
29 40 018	20	11 x 11 x 4	12	1,95



Cuillère Chinoise

Code	Ccl	Φ x Ht cm	Sur.	Prix HT
29 40 065	1	13 x 4,8	60	0,75
29 40 066	0,5	11 x 4,2	60	0,55



Vide poche

Code	Ccl	Φ x Ht cm	Sur.	Prix HT
29 40 064		10 x 2	6	2,02



A. Bol à sauce



B. Coupelle lotus

Code	Ccl	Φ x Ht cm	Sur.	Prix HT
A.29 40 079	10	8 x 3	120	1,95
B.29 40 048	13	8,5 x 3,8	24	1,95

Les Bols



C. Bol à riz



D. Bol calice

Code	Ccl	Φ x Ht cm	Sur.	Prix HT
C.26 47 616	30	11 x 6	3	1,85
D.29 40 301	40	13 x 7,2	6	2,55



E. Bol White



F. Campagne à côtes

Code	Ccl	Φ x Ht cm	Sur.	Prix HT
E.26 30 740	60	14,5 x 8	6	2,65
F.29 40 038	40	13,2 x 7,5	6	2,85



G. Hôtel

Code	Ccl	Φ x Ht cm	Sur.	Prix HT
G.29 40 039	40	13 x 6,5	6	2,85

Grès



Ramequin Octave en grès

Désignation	Ccl	Code	Φ x Ht cm	Sur.	Prix HT
Beige	18	33 56 145	9 x 5	12	1,85
	40	33 56 150	12 x 6	6	3,65
Terracotta	18	33 56 146	9 x 5	12	1,85
	40	33 56 151	12 x 6	6	3,65
Kaki	18	33 56 147	9 x 5	12	1,85
	40	33 56 152	12 x 6	6	3,65



Ramequin Fiorella Ramequin canelle Ramequin blanc Ramequin conique grès

Désignation	Code	Ccl	Φ x Ht cm	Sur.	Prix HT
Ram. Fiorella	33 56 220	20	9 x 5,5	12	2,40
Ram. canelle	33 56 052	22,5	9,3 x 5,6	12	1,65
Ram. conique	29 40 087	10	7-5 x 4	10	1,25
Ramequin	29 40 003	160	19 x 11	2	5,95
	29 40 077	35	11 x 6	72	1,65
	29 40 005	28	10 x 4	12	1,55
	29 40 006	20	9 x 4	12	1,50
	29 40 004	12	8 x 4	12	1,45
	29 40 054	9	7 x 3,5	12	1,25



Ramequin (x6)

Désignation	Code	Ccl	Φ x Ht cm	Sur.	Prix HT
Ramequins (Boîte de 6)	16 13 504	12,5	8 x 4	8	4,97



Ramequin trempé empilable Lyon



Ramequin Pyrex

Désignation	Code	Ccl	Φ x Ht cm	Sur.	Prix HT
Trempé Lyon	75 28 125	14	8,5 x 4,1	36	1,17
Ramequin Pyrex	14 50 103	20	10 x 4,7	12	3,66



Ramequin trempé

Bol parisien lys à oreilles

Bol Parisien transparent

Désignation	Code	Ccl	Φ x Ht cm	Sur.	Prix HT
Trempé Duralex	75 28 121	24	10 x 4	4	1,67
	75 28 120	13	8,5 x 4	96	1,19
Bol à oreilles	75 28 099	51	13,5 x 6,5	6	1,85
Bol Parisien	13 10 205	51	13,5 x 6,5	6	1,94



Beurrier verre



Lot de 3 raviers trempé empilable

Désignation	Code	Ccl	Φ x Ht cm	Sur.	Prix HT
Beurrier	75 16 329	30	17 x 10,5 x 6	6	6,99
Lot 3 raviers	75 16 009	28	14 x 9 x 3,5	8	13,65

Inox



Ramequin Inox

Désignation	Ccl	Code	Φ x Ht cm	Sur.	Prix HT
Ramequin	4,5	47 10 589	6 x 2,5	50	0,86
Inox	7,5	47 10 590	5,7 x 4,2	50	0,97
	12	47 10 591	6,6 x 4,7	50	1,09
	23,5	47 10 592	9 x 6	50	3,25



Coupelle carré trempé empilable duralex



Ravier trempé rectangle empilable duralex

Désignation	Code	Ccl	L x l x Ht cm	Sur.	Prix HT
Carré	75 27 035	30	11 x 11 x 4,6	72	1,31
Rectangle	75 27 037	15	9 x 9 x 3,9	72	1,16
	75 28 115	37	15 x 9 x 4	6	2,32



New products Nouveautés

Coupes verres



Onctuose + couvercle



Chiquito

Désignation	Code	Ccl	Φ x Ht cm	Sur.	Prix HT
Onctuose avec couvercle	75 16 250	22	8,2 x 5,9	24	2,63
Coupelle seule (x 24)	75 16 249	22	8,2 x 5,9	1	33,55
Couvercle seul	75 16 245		8,5 x 1	24	0,85
Chiquito	75 07 154	23	8,3 x 5,9	6	1,51



Ypsilon



Fizz



Ovale

Désignation	Code	Ccl	Φ x Ht cm	Sur.	Prix HT
Ypsilon	75 34 094	39	13 x 9	12	5,18
Fizz	75 34 438	22	9 x 12,4	24	4,03
Ovale	75 42 220	25	11,3 x 8,1	6	4,58



Sorbet GM



Seychelles



Pépite

Désignation	Code	Ccl	Φ x Ht cm	Sur.	Prix HT
Sorbet GM	75 12 010	38	11,7 x 9,4	24	5,80
	75 12 009	22	10 x 7,8	24	4,65
Seychelles	75 12 045	20	10,5 x 7,8	24	2,56
Pépite	75 12 097	20	10,8 x 6	24	3,12



Rock bar



Fortuna

Désignation	Code	Ccl	Φ x Ht cm	Sur.	Prix HT
Rock bar	75 35 130	38	8,5 x 18,8	6	5,00
Fortuna	75 35 186	32	12,5 x 18	6	7,94



Diamond



Diamond basse

Désignation	Code	Ccl	Φ x Ht cm	Sur.	Prix HT
Diamond	75 35 244	36	11,5 x 9,9	6	3,98
	75 35 240	22	10,2 x 8,6	12	3,20
Diamond basse	75 35 238	22	11 x 6	12	3,20

Timeless



Gobelet
(boîte de 4)



Coupe glace
(boîte de 2)



Vap forme haute
(boîte de 4)

Désignation	Code	Ccl	Φ x Ht cm	Sur.	Prix HT
Gobelet (x4)	16 13 216	22,5	9 x 5,4	6	8,51
Coupe glace (x2)	16 11 582	25	9,8 x 10	12	4,96
Vap haute (x4)	16 13 189	32	8,7 x 15	6	13,46



Coupes verres



Jolly



Versatile



Jazzed

Désignation	Code	Ccl	Φ x Ht cm	Sur.	Prix HT
Jolly	75 12 153	35	9,2 x 12,5	24	4,01
	75 12 154	45	9,7 x 13,8	24	4,69
Versatile	75 12 129	12	8,7 x 9	24	2,24
	75 12 128	4	6 x 6,2	12	1,41
Jazzed	75 12 080	41	12,5 x 19,8	12	8,67



Palmier grand



Palmier petit



Quadro

Désignation	Code	Ccl	Φ x Ht cm	Sur.	Prix HT
Palmier grand	75 12 071	37	12 x 20,1	24	8,89
Palmier petit	75 12 070	21	12,5 x 10,1	24	5,14
Quadro	75 12 055	36	8,2 x 19	24	6,31



Simple



Frozen



Diamant

Désignation	Code	Ccl	Φ x Ht cm	Sur.	Prix HT
Simple	75 12 082	25	13,4 x 9,2	12	5,90
Frozen	75 12 145	25	13,4 x 9,2	12	5,90
Diamant	75 12 160	20	10 x 6,2	24	3,21



Vague

A.



B.



Triangle

C.



D.

novastyl

Désignation	Code	Ccl	Φ x Ht cm	Sur.	Prix HT
A. Vague x6	16 18 317	30	11 x 11 x 6	8	7,85
B. Vague x6	16 18 307	6,5	7 x 4	4	4,85
C. Triangle x6	16 18 318	30	12,1 x 5,5	8	7,85
D. Triangle x6	16 18 308	6,9	7 x 4	4	4,85



New products
Nouveautés



**Régal
(lot de 6)**



**Narok
(lot de 6)**



**Invitation
(lot de 6)**

Désignation	Ccl	Code	Φ x Ht cm	Sur.	Prix HT
Régal (x6)	9,5	16 18 062	7,7 x 6	6	4,50
Invitation (x6)	8	16 18 040	5,6 x 6	6	4,75
Narok (x6)	10	16 11 465	5 x 7,8	12	2,88



Barista Chicago (lot de 6)



Boston (lot de 6)

Désignation	Ccl	Code	Φ x Ht cm	Sur.	Prix HT
Chicago (x6)	4,5	16 18 083	5 x 5,5	4	4,50
Boston (x6)	6,2	16 18 084	5 x 7,3	4	4,50



Boston 7cl



Boston 3,5cl



Boston Loop

Désignation	Ccl	Code	Φ x Ht cm	Sur.	Prix HT
Boston	7	75 41 037	5,1 x 8,3	12	0,92
	3,5	75 41 036	4,9 x 5,9	12	0,92
Boston Loop	3	75 41 038	4,3 x 7	12	0,92



**Elysia
(lot de 6)**



**Timeless
(lot de 4)**



Casablanca

Désignation	Ccl	Code	Φ x Ht cm	Sur.	Prix HT
Elysia (x6)	6	16 13 084	4,6 x 6,6	4	9,66
Timeless (x4)	6	16 13 214	4,8 x 6,2	12	6,21
Casablanca	3,6	75 41 191	4,8 x 5,5	12	0,75



Mini rock bar



Mini rock bar



Dublino



Désignation	Ccl	Code	Φ x Ht cm	Sur.	Prix HT
Shot Barglass	6,5	75 34 532	4,7 x 7	48	1,68
Mini rock bar	7	75 25 072	5,1 x 6,4	54	1,10
Dublino	5,7	75 34 039	5 x 9	48	1,31
	3,4	75 34 040	4,5 x 7	72	1,07



Cafféino



Caravelle



Novecento



Désignation	Ccl	Code	Φ x Ht cm	Sur.	Prix HT
Cafféino	8,5	75 30 035	5,9 x 7,1	48	0,97
Caravelle	10	75 30 006	5,7 x 6,8	24	0,92
	4,5	75 30 007	4,4 x 5,4	48	0,87
Novecento	7,7	75 34 502	5,5 x 7,9	24	2,30



Gigogne



Picardie



Désignation	Ccl	Code	Φ x Ht cm	Sur.	Prix HT
Gigogne	9	75 25 025	5,8 x 6	72	0,81
Picardie	9	75 25 060	6,5 x 6,7	144	0,88

ARCOROC



Gin



Salto



Baril

Désignation	Ccl	Code	Φ x Ht cm	Sur.	Prix HT
Gin	5	75 05 037	4,8 x 5,7	288	0,97
	3,5	75 05 020	4,2 x 5,2	24	0,90
Salto	6,5	75 06 108	4,8 x 6,6	48	1,55
Baril	16	75 05 006	5,7 x 8	48	1,08



Islande



Vigne



Hot shot

Désignation	Ccl	Code	Φ x Ht cm	Sur.	Prix HT
Islande	6,5	75 06 493	3,8 x 10,5	12/72	0,99
Vigne	6	75 06 146	3,8 x 10,5	48	1,31
Hot shot	7	75 05 066	5,5 x 8,5	48	1,55
	3,4	75 05 065	4,5 x 7	24	1,40



Conique



Stack-up



Granity

Désignation	Ccl	Code	Φ x Ht cm	Sur.	Prix HT
Conique	8	75 05 004	5 x 7,8	48	1,10
Stack-up	4,5	75 07 239	5 x 6	48	1,35
Granity	4,5	75 07 093	5 x 5,7	48	1,31



Shetland



Eskale

Désignation	Ccl	Code	Φ x Ht cm	Sur.	Prix HT
Shetland	15	75 06 069	7 x 9	48	1,81
	9	75 06 068	6 x 7,3	48	1,51
Eskale	18	75 15 287	7,7 x 7,8	24	1,91
	9	75 15 288	6,2 x 6,4	24	1,75



Stockholm



Véga

Désignation	Ccl	Code	Φ x Ht cm	Sur.	Prix HT
Stockholm	4,5	75 05 024	4,3 x 5,2	48	0,97
Véga	4	75 16 380	5 x 3,8	24	1,32



New York shot non trempé

Désignation	Ccl	Code	Φ x Ht cm	Sur.	Prix HT
New york (3 motifs assortis)	3,4	75 07 338	4,4 x 5,5	24	1,23



Juliet - Grès et Acacia



Blanche

Bleu

Perle

Amande

Jaune

Paprika

Kaki

Désignation	Code	Ccl	Φ x Ht cm	Sur.	Prix HT
Blanche	79 12 019	47,5	9-14 x 14	6	9,85
	79 12 168	30	9-12,5 x 11	6	8,50
Bleu	79 12 015	47,5	9-14 x 14	6	9,95
	79 12 167	30	9-12,5 x 11	6	8,50
Perle	79 12 014	47,5	9-14 x 14	6	9,95
	79 12 166	30	9-12,5 x 11	6	8,50
Amande	79 12 013	47,5	9-14 x 14	6	9,95
	79 12 165	30	9-12,5 x 11	6	8,50

Désignation	Code	Ccl	Φ x Ht cm	Sur.	Prix HT
Jaune	79 12 030	47,5	9-14 x 14	6	9,85
	79 12 169	30	9-12,5 x 11	6	8,50
Paprika	79 12 032	47,5	9-14 x 14	6	9,85
	79 12 170	30	9-12,5 x 11	6	8,50
Kaki	79 12 034	47,5	9-14 x 14	6	9,85
	79 12 171	30	9-12,5 x 11	6	8,50



2 FORMATS

Tisanières en grès coloré : 30 et 47,5 cl pour des moments de dégustation adaptés à vos envies, alliant style et praticité.



Enzo - Porcelaine



Théière Enzo 68 cl
avec couvercle bois d'hêtre et infuseur inox

Désignation	Code	Ccl	Φ x Ht cm	Sur.	Prix HT
Théière Enzo	79 12 045	68	18-11,5 x 12	6	16,85

Mona - Porcelaine



Théière en Mona porcelaine
avec couvercle bois d'hêtre et infuseur inox

Désignation	Code	Ccl	Φ x Ht cm	Sur.	Prix HT
Théière Mona	79 12 106	100	22 x 14 x 13	6	18,50

Hôtellerie - Porcelaine



Wersal



Ameryka

Désignation	Code	Ccl	Φ x Ht cm	Sur.	Prix HT
Wersal	26 91 275	60	22 x 9	12	14,23
Ameryka	26 91 074	40	16 x 10	12	13,26



Pichet à anse renforcée

Désignation	Code	Ccl	Φ x Ht cm	Sur.	Prix HT
Pichet à anse	29 40 434	75	8,5-13 x 13	2	13,50
	29 40 433	50	8-12 x 11,5	6	10,85
	29 40 436	30	10,5 x 7,5 x 10	6	8,35
	29 40 432	12	7,5 x 8	4	2,00



Paprika

Jaune

Bleu

Amande

Noir

Désignation	Code	Ccl	L x l x Ht cm	Sur.	Prix HT
Paprika	79 12 175	100	20 x 15 x 13,5	6	28,95
	79 12 180	50	17 x 12 x 11,3	6	21,80
Jaune	79 12 176	100	20 x 15 x 13,5	6	28,95
	79 12 181	50	17 x 12 x 11,3	6	21,80
Bleu	79 12 177	100	20 x 15 x 13,5	6	28,95
	79 12 182	50	17 x 12 x 11,3	6	21,80

Désignation	Code	Ccl	Φ x Ht cm	Sur.	Prix HT
Amande	79 12 178	100	20 x 15 x 13,5	6	28,95
	79 12 183	50	17 x 12 x 11,3	6	21,80
Noir	79 12 179	100	20 x 15 x 13,5	6	28,95
	79 12 184	50	17 x 12 x 11,3	6	21,80

COUVERCLE BOIS

FILTRE INOX
Infuseur micro-perforé : saveurs optimales.

MANCHE BOIS

FONTE D'ACIER
La fonte d'acier préserve élégamment la chaleur, alliant durabilité et style.





Théière compatible tous feux, dont induction



FILTRE AMOVIBLE

Équipée d'un infuseur amovible en acier inoxydable pour le thé en vrac. Facile à nettoyer.



Théières en fonte



Osaka Théière en fonte noire
Grand format 1,5L

Fuji Théière en fonte bleue 80cl

Désignation	Code	Ccl	Φ x Ht cm	Sur.	Prix HT
Osaka grand format	73 21 423	150	20 x 12,5	4	26,50
Osaka moyen format	73 21 528	120	14 x 10,5	4	22,50
Fuji	73 21 629	80	18 x 10,5	4	22,50

Laska



Ambre

Gris

Vert

Coloris	Code	Ccl	Φ x Ht cm	Sur.	Prix HT
Ambre	79 12 215	45	11 x 13	6	12,95
Gris	79 12 216	45	11 x 13	6	12,95
Vert	79 12 217	45	11 x 13	6	12,95

Hera - Lot de 2



Tasses 35cl

Tasses 25cl

Désignation	Code	Ccl	Φ x Ht cm	Sur.	Prix HT
Tasses (x2)	79 12 227	35	8 x 12	8	9,30
	79 12 226	25	8 x 9,5	8	7,40
	79 12 225	12	6,5 x 7,3	8	5,30



Carafe Viktor, double paroi
couvercle infuseur



Théière Oscar
infuseur en verre

Désignation	Code	Ccl	Φ x Ht cm	Sur.	Prix HT
Carafe Viktor	79 12 052	65	10 x 21,5	24	16,50
Théière Oscar	79 12 001	55	13 x 14	6	12,50



Théière Mugi 90cl
couvercle en acacia



Théière Sofia 50cl
couvercle en acacia

Désignation	Code	Ccl	Φ x Ht cm	Sur.	Prix HT
Théière Mugi	79 12 208	90	15 x 14	6	20,79
Théière Sofia	79 12 107	50	18 x 15	6	18,50



Leia - Lot de 2



Tasses 10cl

Tasses 35cl

Tasses 25cl

Désignation	Code	Ccl	Φ x Ht cm	Sur.	Prix HT
Tasses (x2)	79 12 232	35	7 x 11 x 11	8	6,90
	79 12 231	25	6,5 x 10 x 10	8	6,10
	79 12 230	10	6 x 8 x 5	8	3,90

Gustave



Théière 68cl

Théière 120cl

Carafe infuseur

Désignation	Code	Ccl	Φ x Ht cm	Sur.	Prix HT
Théière	79 12 102	68	19 x 12	6	14,50
	79 12 104	100	25 x 13	6	18,50
	79 12 099	120	9 x 18,5 x 18	6	21,50
	79 12 050	150	10 x 27	6	24,95



Tisanière



Tisanière simple paroi



Tisanière double paroi

Désignation	Code	Ccl	L x l x Ht cm	Sur.	Prix HT
Tisanière	79 12 103	30	9 x 12 x 10	12	6,85
Simple paroi	79 12 005	45	8,5 x 13 x 13	12	7,75
Double paroi	79 12 004	10	9,1 x 13 x 12,512	12	9,95

Karl

Service à thé



Théière solitaire

Pichet 2L

Désignation	Code	Ccl	L x l x Ht cm	Sur.	Prix HT
Théière solitaire	79 12 198	40	18 x 19 x 9,5	6	41,62
Pichet Karl	79 12 220	200	12,5 x 16,7 x 25	6	39,29



Lot 2 Tasses 25cl

Désignation	Coloris	Code	Φ x Ht cm	Sur.	Prix HT
Tasses (x2)	Blanc	79 12 195	8 x 10,6	6	6,45
	Gris	79 12 196	8 x 10,6	6	6,45



Théières 55cl



Théières 1,2L



Tisanière 30cl



Tisanière 45cl

Désignation	Coloris	Code	L x l x Ht cm	Sur.	Prix HT
Théière 55cl	Ambre	79 12 200	18 x 10 x 13,5	6	14,95
	Gris	79 12 201	18 x 10 x 13,5	6	14,95
	Vert	79 12 202	18 x 10 x 13,5	6	14,95
Théière 1,2L	Ambre	79 12 205	11 x 20 x 16,5	6	19,95
	Gris	79 12 206	11 x 20 x 16,5	6	19,95
	Vert	79 12 207	11 x 20 x 16,5	6	19,95

Désignation	Coloris	Code	Φ x Ht cm	Sur.	Prix HT
Tisanière 30cl	Ambre	79 12 185	12,5 x 9 x 10	6	8,50
	Gris	79 12 186	12,5 x 9 x 10	6	8,50
	Vert	79 12 187	12,5 x 9 x 10	6	8,50
Tisanière 45cl	Ambre	79 12 190	12,5 x 9 x 13	6	9,85
	Gris	79 12 191	12,5 x 9 x 13	6	9,85
	Vert	79 12 192	12,5 x 9 x 13	6	9,85



New products
Nouveautés

Infuseurs



A. Infuseur tube en verre Ycare



B. Infuseur Gaspard



C. Infuseur Oscar anse et socle acacia, panier inox, couvercle silicone



D. Infuseur Luke panier inox, couvercle acacia



E. Infuseur Sven couvercle bois



F. Boule à thé inox

Désignation	Code	Φ x Ht cm	Sur.	Prix HT
A. Ycare	79 12 048	3 x 13,5	24	5,25
B. Gaspard	79 12 047	5,8 x 3,5 x 14	12	8,25
C. Oscar	79 12 018	4,8 x 14,5	20	5,95

Désignation	Code	Φ x Ht cm	Sur.	Prix HT
D. Luke	79 12 017	5,5-7 x 10	20	9,85
E. Sven	79 12 060	6,6 x 4,5 x 9	12	4,55
F. Boule à thé	50 41 046	4,5 x 4,5	48	1,78

Moulins café à manivelle



Moulin à café naturel

Moulin à café Isaak

Moulin à café Auguste

Désignation	Code	L x l x Ht cm	Sur.	Prix HT
Naturel	79 11 161	9,5 x 6,5 x 17,7	6	21,50
Auguste	79 11 151	20,5 x 11,5 x 24	4	34,95
Isaak	79 11 150	4,8 x 13	6	10,50



Cafetière à piston



Cafetière à piston Keygo



Cafetière à piston Helya

Désignation	Code	Ccl	Φ x Ht cm	Sur.	Prix HT
Keygo	79 12 055	130	10 x 17,5 x 21,5	6	21,50
Helya	79 12 002	80	15 x 23	6	21,50

Accessoires



Pot à verser empilable inox 18.10



Porte filtre

Désignation	Code	Φ x Ht cm	Sur.	Prix HT	
Pot inox 18.10	47 37 012	200	14 x 17,5	6	33,03
	47 37 011	150	12 x 16,5	6	29,68
	47 37 010	100	11 x 14,5	6	24,84
Porte filtre	54 20 325		7,5 x 15	12	2,45



Service à thé et café



Tasse et soucoupe Aroma



Tasse et soucoupe Voluto



Mug Voluto

Désignation	Code	Ccl	Φ x Ht cm	Sur.	Prix HT
Tasse Aroma	75 51 353	22	10 x 8,5	48	4,17
scp	75 51 360		14 x 2,1	48	3,28
	75 51 352	8	7,6 x 6,4	48	3,01
scp	75 51 359		12 x 1,9	48	2,81
Tasse Voluto	75 52 122	22	10,7 x 7,1	24	1,67
scp	75 51 360		14 x 2,1	48	3,28
	75 52 125	9	8,4 x 6,8	24	1,58
scp	75 51 359		12 x 1,9	48	2,81
Mug Voluto	75 52 126	40	11 x 12,3	24	2,60
	75 52 124	32	10,6 x 11	24	1,96
	75 52 123	25	10,4 x 9,1	24	1,73



Lot de 2 chopes macchiato



Lot de 2 mugs



Lot de 2 tasses à thé

Désignation	Code	Ccl	Φ x Ht cm	Sur.	Prix HT
Macchiato	75 36 408	34	8,9 x 15	6	16,61
Mugs (x2)	16 15 501	29,5	8 x 11,8	6	16,87
	16 15 500	12	8 x 7	6	13,47
Tasse à thé	16 15 502	38,5	11,3 x 8,6	6	23,25



Lot de 2 Ametista



Lot de 2 Cylindrical



Lot de 2 Caféino



Lot de 2 chopes juice

Désignation	Code	Ccl	Φ x Ht cm	Sur.	Prix HT
Ametista	16 15 513	11	8,6 x 8,1	6	7,92
Cylindrical	16 15 510	11	6,2 x 6,9	6	7,92
Caféino	75 36 406	8,5	6,2 x 7,4	6	8,86
Chope juice	75 36 407	27	8,2 x 11,3	6	14,47



Mug versaille empilable trempé



Bock thé non trempé



Mug basic



Caféino



Lot de 6 verre à thé Ceylan (3 décors assortis)

Désignation	Code	Ccl	Φ x Ht cm	Sur.	Prix HT
Versaille	13 10 018	26	7 x 9	6	1,67
Bock	75 50 524	23	7 x 10,5	24	3,01
Mug	75 41 105	35	12 x 9,5	24	2,36
Caféino	75 30 035	8,5	5,9 x 7,1	48	0,97
Ceylan (x6)	16 11 493	10	5 x 7,8	8	6,50

Riga

novastyl



Théière Riga avec infuseur et couvercle en acacia

Désignation	Code	Ccl	Φ x Ht cm	Sur.	Prix HT
Théière	30 20 340	100	9,5 x 16 x 17	4	17,90



Mug Riga

Désignation	Coloris	Code	Ccl	Φ x Ht cm	Sur.	Prix HT
Mug	Bleu	30 20 325	44	9,5-13,5 x 10	6	3,15
	Beige	30 20 326	44	9,5-13,5 x 10	6	3,15
	Marron	30 20 327	44	9,5-13,5 x 10	6	3,15
	Amande	30 20 328	44	9,5-13,5 x 10	6	3,15



Bol Riga

Tasse Riga

Désignation	Coloris	Code	Ccl	Φ x Ht cm	Sur.	Prix HT
Bol	Bleu	30 20 330	57	14 x 7	6	3,35
	Beige	30 20 331	57	14 x 7	6	3,35
	Marron	30 20 332	57	14 x 7	6	3,35
	Amande	30 20 333	57	14 x 7	6	3,35
Tasse	Bleu	30 20 336	11	6,2 x 6,2	6	1,55
	Marron	30 20 335	11	6,2 x 6,2	6	1,55

Café gourmand



Tasse Paula et sous-tasse

Code	Ccl	L x l x Ht cm	Sur.	Prix HT
26 91 415	20	8,6-11 x 7	6	3,92
scp 26 91 416		14 x 1,7	6	2,65
26 91 410	7	6,2-8,2 x 6	6	3,06
scp 26 91 411		12 x 1,5	6	1,94



Paire tasse Alaska

Code	Ccl	L x l x Ht cm	Sur.	Prix HT
26 30 373	22	7,5-9 x 8,2	6	3,67
scp		14,5		



Paire tasse Metropolitan
(Boîte de 6)

Code	Ccl	L x l x Ht cm	Sur.	Prix HT
26 30 867	10	6,5 x 5,5	6	13,50
26 30 868	20	8,3 x 7,5	6	16,50



Plateau Paula

Code	Ccl	L x l x Ht cm	Sur.	Prix HT
Plateau Paula				
26 91 420		20 x 13 x 2,3	6	7,48
Tasses compatibles				
26 91 415	20	8,6-11 x 7	6	3,92
26 91 410	7	6,2-8,2 x 6	6	3,06



Tasse Wersal et sous-tasse

Code	Ccl	L x l x Ht cm	Sur.	Prix HT
26 91 271	20	9,3-12 x 5,6	24	3,86
26 91 270		14,5 x 1,8	24	2,43



Hel bol empilable et sous-tasse

Code	Ccl	L x l x Ht cm	Sur.	Prix HT
26 91 068	32	10,5 x 6	6	6,90
scp 26 91 067		16 x 2,4	12	1,89



Tasse Boule empilable et sous-tasse

Code	Ccl	L x l x Ht cm	Sur.	Prix HT
29 40 332	20	9-11 x 6,5	12	4,65
scp 29 40 333		14,5 x 1,8	12	2,36
29 40 330	8	6,2-8 x 5,5	12	3,65
scp 29 40 331		12 x 1,5	12	1,99



Tasse Nadia et sous-tasse

Code	Ccl	L x l x Ht cm	Sur.	Prix HT
26 91 216	22	9,6-12 x 5,6	12	3,92
scp 26 91 217		16 x 1,8	12	2,65
26 91 214	10	7-8,8 x 5,8	12	3,57
scp 26 91 215		13,5 x 1,5	12	2,17



Tasse Hel empilable et sous-tasse

Code	Ccl	L x l x Ht cm	Sur.	Prix HT
26 91 066	25	9,5-12 x 6	12	4,15
scp 26 91 067		16 x 2,4	12	1,89
26 91 064	20	8,5-11 x 6	12	2,90
scp 26 91 065		15 x 2,3	12	2,17
26 91 062	15	8-10 x 6	12	2,76
scp 26 91 063		13,5 x 2	12	1,94
26 91 060	9	5,8-8 x 6	12	2,57
scp 26 91 061		12 x 1,8	12	1,62



Tasse Ambassador et sous-tasse

Code	Ccl	L x l x Ht cm	Sur.	Prix HT
26 15 084	20	8-10,5 x 6	6	3,43
scp 26 15 085		16 x 1,8	6	1,91
26 15 080	10	6-7,8 x 5	6	2,01
scp 26 15 081		12,5 x 1,6	6	1,38



Tasse Empilable standard et sous-tasse

Code	Ccl	L x l x Ht cm	Sur.	Prix HT
29 40 114	20	7-9,4 x 7,2	6	1,45
scp 29 40 115		14 x 1,8	6	1,35
29 40 110	9	5,5-7,3 x 6,2	6	1,45
scp 29 40 111		12,6 x 1,7	6	1,35

Urus - Porcelaine



Tasse 21cl



Soucoupe

Désignation	Coloris	Code	Ccl	Φ x Ht cm	Sur.	Prix HT
Tasse	Bleu	79 32 182	21	9,2 x 6,5	6	5,50
	Beige	79 32 197	21	9,2 x 6,5	6	5,50
	Bleu	79 32 180	9	6,7 x 5,2	6	4,50
	Beige	79 32 195	9	6,7 x 5,2	6	4,50
	Soucoupe	Bleu	79 32 183	15 x 1,8	6	4,50
Beige		79 32 198	15 x 1,8	6	4,50	
Bleu		79 32 181	12 x 1,7	6	4,50	
Beige		79 32 196	12 x 1,7	8	4,50	



Bol 10cl



Bol 24cl



Bol 80cl

Désignation	Coloris	Code	Ccl	Φ x Ht cm	Sur.	Prix HT
Bol	Bleu	79 32 184	10	8 x 4,5	12	3,95
	Beige	79 32 199	10	8 x 4,5	12	3,95
	Bleu	79 32 205	11	8 x 5	12	3,95
	Bleu	79 32 185	24	10 x 5,7	12	5,50
	Beige	79 32 200	24	10 x 5,7	12	5,50
	Bleu	79 32 206	80	18 x 5	4	12,95
	Beige	79 32 207	80	18 x 5	4	12,95

Aronal
& Boral
- GrèsMug 45cl
AronalBol 50cl
AronalBol 50cl
Boral

Désignation	Code	Ccl	Φ x Ht cm	Sur.	Prix HT
Mug	79 32 084	45	12,5 x 8,5 x 10,5	6	3,25
Bol	79 32 243	50	17 x 6	6	4,95
Bol	79 32 253	50	17 x 6	6	4,95



Ora - Porcelaine



Tasse 16cl



Mug 32cl

Désignation	Code	Ccl	Φ x Ht cm	Sur.	Prix HT
Tasse	79 32 361	16	7,5 x 6,5	4	3,95
Mug	79 32 362	32	9,2 x 10	4	5,95



Bock empilable - Grès



Mug White - Porcelaine

Désignation	Code	Ccl	L x l x Ht cm	Sur.	Prix HT
Bock empilable	29 40 117	25	7,7-10,4 x 8,7	6	1,35
Mug White	29 40 119	35	8,2-11,7 x 10,2	6	2,15

Vita - Céramique



Tasse 18cl



Jumbo 50cl



Mug 34cl



Bol 64cl

Désignation	Coloris	Code	Ccl	Φ x Ht cm	Sur.	Prix HT
Tasse	Ivoire	30 20 283	18	7,3 x 8	6	1,35
	Gris	30 20 294	18	7,3 x 8	6	1,35
Mug	Ivoire	30 20 284	34	8,5 x 10,2	6	1,45
	Gris	30 20 295	34	8,5 x 10,2	6	1,45
Jumbo	Ivoire	30 20 285	50	11,5 x 8,2	6	2,10
	Gris	30 20 296	50	11,5 x 8,2	6	2,10
Bol	Ivoire	30 20 286	64	14,6 x 8	6	2,10
	Gris	30 20 297	64	14,6 x 8	6	2,30

Grès



Oli
p.96



Nova
p.97



Aronal
p.98



Boral
p.99



Katanga
p.100



Grenada
p.100

Porcelaine



Urus
p.88-91



Ora
p.92



Sigma
p.93



Vénus
p.94



Saturne
p.95

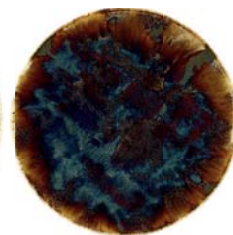

Volcano
p.95

Porcelaine



Omega
p.102



Thera
p.103



Delta
p.104-105



Mellow
p.106-107



Reckless
p.108-109



Tiffany
p.110

Porcelaine



Modest
p.111



Lagoon Ocean
p.112-113



Alhambra
p.114



Albus
p.115



East White
p.116



Viento
p.117

Porcelaine



Luca Mozaic
p.118



Lunar Ocean
p.119



Hornfels
p.120



Aura Space
p.121



Aura Passion
p.121



Atome
p.122

Porcelaine



Nuance
p.123



Palmeraie
p.124



Spirale
p.124



Botanic
p.125



Byzance
p.126



Maka
p.126

Porcelaine



Lachat
p.127



Natura
p.127



Jasmin
p.128



Aqua
p.128



Savane
p.129



Dune
p.129

Porcelaine



Jaipur
p.130



Héraclée
p.130

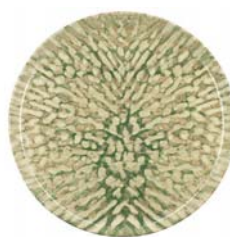

Jade
p.131



Ambre
p.131



Floral
p.132



Faustine
p.132

Porcelaine

Faïence

Porcelaine Blanche



Charlotte
p.133



Capria
p.134



Amatxi
p.135



White
p.136



Metropolitan
p.137



Alaska
p.137

Porcelaine Blanche



Ambassador
p.138



Polo
p.138



Carré Hôtel
p.139



Classic Filet or
p.140



Carbone
p.140



Wersal
p.142

Porcelaine Blanche

Spécifiques



Roma
p.142



Martelé
p.143



Risotto
p.143



Pasta
p.144



Pizza
p.144



Inclinés
p.144

Spécifiques

Porcelaine Vitriifiée



Compartiments
p.144



Creuses/Coupes
p.145



Saladiers
p.145



Carpaccio
p.146



Steak
p.146



Oslo
p.147

Opal

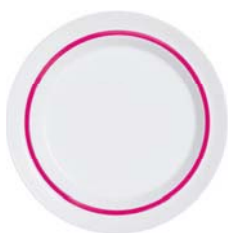

Autonomy
p.148



Heat System
p.148



Nova Aquitana
p.148



Restaurant Filet
p.149



Restaurant Uni
p.149



Brush
p.149

Opal



Evolutions Black
p.150



Stairo
p.151



Feston
p.151



Génération
p.152



Picardie
p.152



Saladiers
p.153

Verre

Mélamine



Kuwaé
p.154

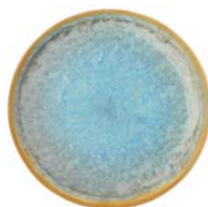

Rivage
p.154



Plat en Verre
p.152



Saladier Inox
p.154



Bols
p.156



Ramequins
p.157

Compléments

Compléments



Coupes en verre
p.158-159



Mises en bouche
p.160-161



Service à thé
p.162-165



Service à café
p.166



Petit Déjeuner
p.167



Tasses en porcelaine
p.168-169



New products
Nouveautés 2026



Trinox Revêtu

Une gamme en acier inoxydable dotée d'un revêtement céramique nid d'abeille, alliant résistance et performance de cuisson.



Alu Pro

Une collection professionnelle en aluminium dotée d'un revêtement céramique haute performance



New products
Nouveautés 2026

Le Parfait



Easynox

Une collection en aluminium et inox, déclinée dans des teintes douces Brume, Écume et Corail, alliant légèreté et performance de cuisson au quotidien.



Bocal Bistrot Le Parfait

Un bocal idéal pour une conservation optimale, disponible en différentes tailles.



03

CUISSON



- Acier Inoxydable 176 à 185
- Aluminium 186 à 191
- Fonte Émaillée 194
- Tajines et Couscous 195 à 196
- Émail 197
- Cuisson au four - Grès 198
- Cuisson au four - Acier carbone 199 à 201
- Bacs gastronomiques 202 à 203
- Cuisson au four - Verre 204 à 208
- Storage 209 à 215
- Matériel électrique 216 à 219



TRIPLY,

La collection made in France pour les professionnels de la restauration !



CUISSON

Durabilité & ROBUSTESSE



CUISSON PRO, SAINE & DURABLE

Sans substances nocives, précise et rapide grâce à la technologie 3 couches :



GRADUATIONS
Jauger rapidement la capacité

BORD VERSEUR
Simplifier le versement

1 COUCHE INTÉRIEURE
INOX 304
0,4mm

2 COUCHE INTERMÉDIAIRE
ALUMINIUM
1mm

3 COUCHE EXTÉRIEURE
INOX 430
0,6mm

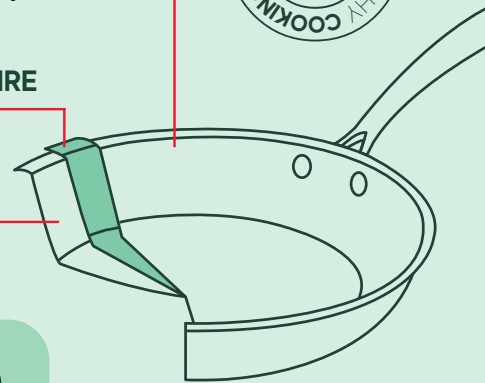

Four



Gaz



Électrique



Vitro-céramique



Induction



Triply

LA COLLECTION

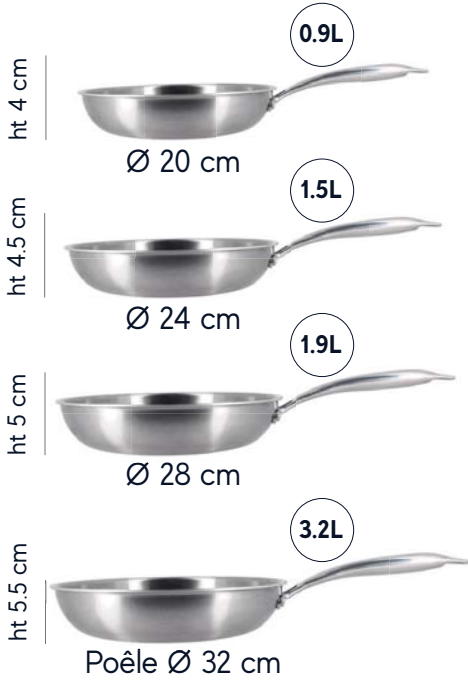

Désignation	Litres	Code	Φ x Ht cm	SUR.	Prix HT
Poêle	0,9	60 20 485	20 x 4	6	26,63
	1,5	60 20 486	24 x 4,5	6	29,51
	1,9	60 20 487	28 x 5	6	33,94
	3,2	60 20 488	32 x 5,5	6	41,05
Casserole	1,85	60 20 489	16 x 7	6	25,59
	2	60 20 490	18 x 8	6	28,68
	3	60 20 491	20 x 9	6	31,88

Désignation	Litres	Code	Φ x Ht cm	SUR.	Prix HT
Sauteuse	3	60 20 529	24 x 8,5	4	40,90
Wok	4	60 20 519	24 x 8	4	35,90
	4	60 20 492	28 x 8,5	4	38,51
Faitout	4,5	60 20 518	24 x 12	4	54,85
Crêpière		60 20 534	28 x 2,4	6	37,65



New products
Nouveautés

TRINOX,
L'inox triple couche
haute résistance



Désignation	Litres	Code	Φ x Ht cm	SUR.	Prix HT
Poêle	1,5	60 20 145	24 x 4,5	6	13,50
	1,9	60 20 146	28 x 5	6	14,95
	2,7	60 20 147	30 x 5	6	16,05
Casserole	2	60 20 148	18 x 9	6	13,25
	3	60 20 149	20 x 10	6	14,95

Désignation	Litres	Code	Φ x Ht cm	SUR.	Prix HT
Faitout	3	60 20 151	20 x 10	6	24,75
	4,5	60 20 152	24 x 12	6	26,40

3 COUCHES TRI-PLY

1 COUCHE EXTÉRIEURE INOX 430 0,6mm

2 COUCHE INTERMÉDIAIRE ALUMINIUM 1mm

3 COUCHE INTÉRIEURE INOX 304 0,4mm



Four



Gaz



Électrique



Vitro-céramique



Induction

POIGNÉE CHEF
Non conductrice
de la chaleur

Trinox Revêtu

TRINOX REVÊTU,

L'inox triple couche haute résistance, associé à un revêtement céramique performant

COUCHE EXTÉRIEURE 1
INOX 430 0,6mm

COUCHE INTERMÉDIAIRE 2
ALUMINIUM 1mm

COUCHE INTÉRIEURE 3
INOX 304 0,4mm

REVÊTEMENT CÉRAMIQUE NID D'ABEILLE
Ultra résistant

POIGNÉE CHEF
Non conductrice de la chaleur



Four



Gaz



Électrique



Vitro-céramique



Induction



CUISSON



Désignation	Litres	Code	Φ x Ht cm	SUR.	Prix HT
Poêle	0,9	60 21 060	20 x 4,5	6	16,75
	1,5	60 21 061	24 x 4,5	6	17,95
	1,9	60 21 062	28 x 5	6	20,50
	2,7	60 21 063	30 x 5	6	22,85
Sauteuse	3	60 21 066	24 x 6,5	6	27,95
Casserole	1	60 21 064	14 x 7	6	16,85
	1,85	60 21 065	16 x 8	6	18,95

Désignation	Litres	Code	Φ x Ht cm	SUR.	Prix HT
Wok	4	60 21 067	28 x 8,5	3	23,95
Faitout	3	60 21 068	20 x 10	2	32,50
	4,5	60 21 069	24 x 12	2	41,95

New products Nouveautés



INOX PRO,

La qualité professionnelle,
robuste et durable !

CUISSON

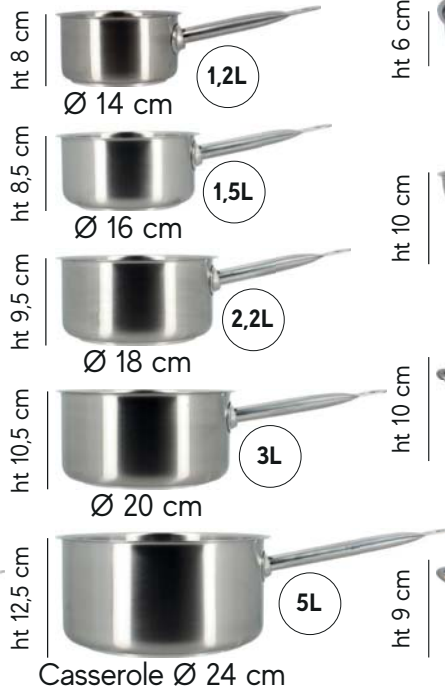
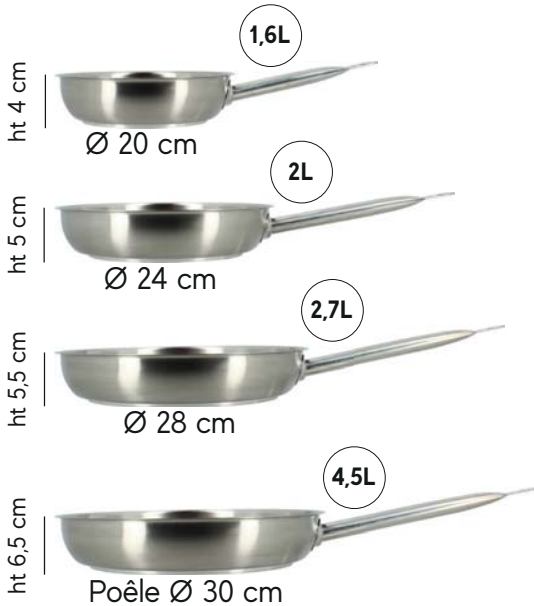

Désignation	Litres	Code	Φ x Ht cm	SUR.	Prix HT
Poêle	1,6	75 20 060	20 x 4	6	16,85
	2	75 20 061	24 x 5	6	22,45
	2,7	75 20 062	28 x 5,5	6	24,55
	4,5	75 20 063	30 x 6,5	6	26,55
Casserole	1,2	75 20 001	14 x 8	6	13,55
	1,5	75 20 002	16 x 8,5	6	14,55
	2,2	75 20 003	18 x 9,5	6	16,85
	3	75 20 004	20 x 10,5	6	18,75
	5	75 20 005	24 x 12,5	4	27,25

Désignation	Litres	Code	Φ x Ht cm	SUR.	Prix HT
Poêle poisson	3,8	60 20 260	37,5 x 6	4	31,15
Wok	5,1	75 20 065	30 x 10	6	25,80
Marmite	2,7	75 20 038	24 x 10	4	38,85
Sautreuse	4,5	75 20 016	28 x 9	4	38,95



Inox pro



Four



Gaz



Électrique

Vitro-
céramique

Induction

POIGNÉE TUBULAIRENon conductrice
de la chaleur**3** COUCHE EXTÉRIEURE
INOX 430**2** COUCHE INTERMÉDIAIRE
ALUMINIUM**1** COUCHE INTÉRIEURE
INOX 304

EASYNEX
LINOX 304 FACILE



**ULTRA-LÉGÈRE
NATURELLEMENT SAINE**



CUISSON

LA COLLECTION Poignée fixe



Désignation	Litres	Code	Φ x Ht cm	SUR.	Prix HT
Poêle	1,2	60 21 001	20 x 4	6	12,55
	1,9	60 21 002	24 x 5,5	6	15,20
	2,9	60 21 003	28 x 5,5	6	17,85
Casserole	1,5	60 21 004	16 x 8	6	13,15
	2,1	60 21 005	18 x 8,5	6	15,30
	2,7	60 21 006	20 x 9,5	6	16,45

Désignation	Litres	Code	Φ x Ht cm	SUR.	Prix HT
Faitout	4,8	60 21 008	24 x 8	3	24,45
Wok	4,1	60 21 010	28 x 12,5	6	22,65

*Le Meilleur
des 2 mondes* 

INOX 
Le choix santé

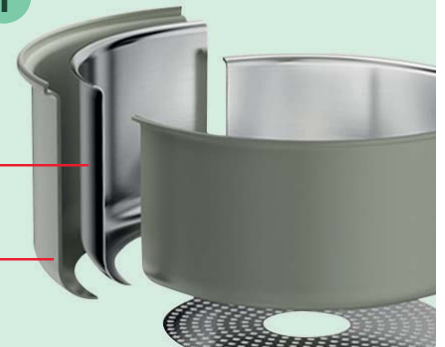

 **ALUMINIUM**
La Cuisson homogène

LA COLLECTION

Amovible



LA COMPOSITION



ht 5 cm



Ø 24 cm

ht 8,5 cm



Ø 18 cm

ht 5,5 cm



Poêle Ø 28 cm

ht 9 cm



Casserole Ø 20 cm



Four



Gaz



Électrique



Vitro-
céramique



Induction

Désignation	Code	SUR.	Prix HT
Bleu vert	60 21 015	6	56,35
Corail	60 21 016	6	56,35
Ivoire	60 21 017	6	56,35



Iris Inox

L'INOX
LE MEILLEUR CHOIX
POUR UNE
Cuisson Saine

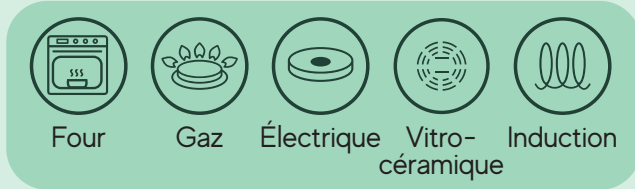

1 ACIER INOXYDABLE 304

Épaisseur 0,5 mm

2 ALUMINIUM

Fond sandwich renforcé

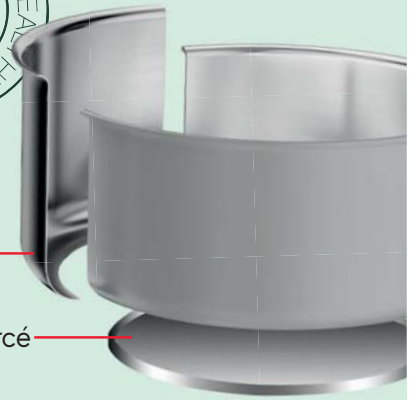

LA COLLECTION

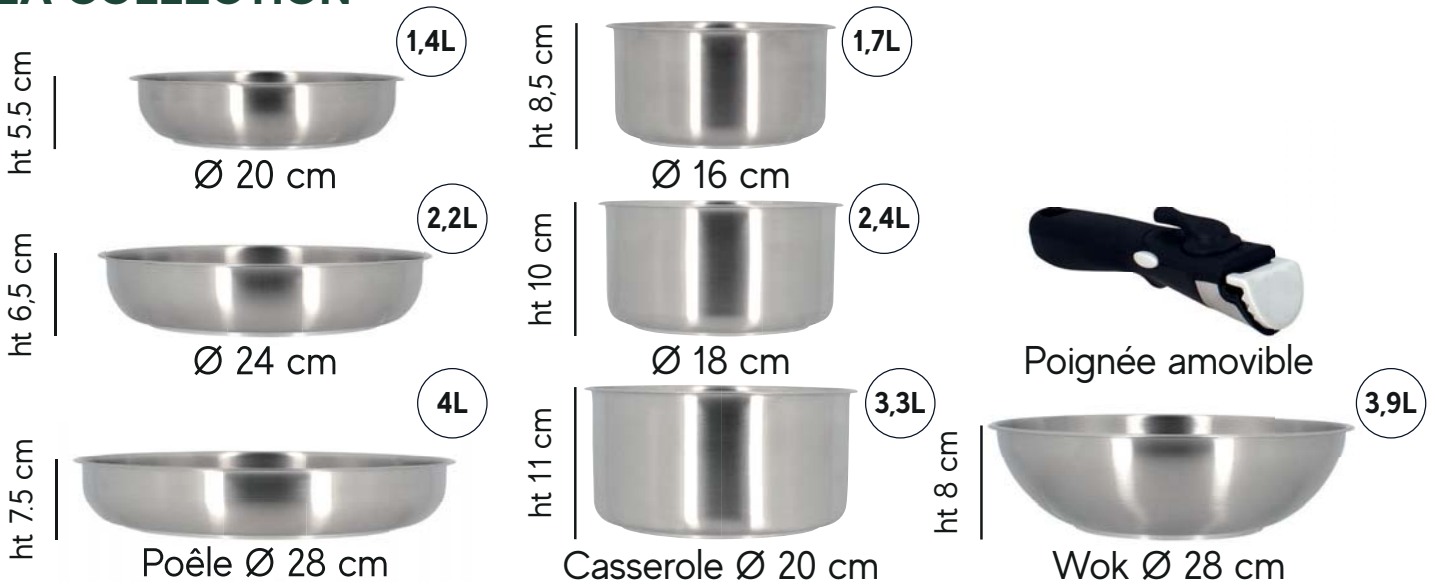

Désignation	Litres	Code	Φ x Ht cm	SUR.	Prix HT
Poêle	1,4	79 30 100	20 x 5,5	3	13,25
	2,2	79 30 101	24 x 6,5	3	16,65
	4	79 30 103	28 x 7,5	3	19,95

Désignation	Litres	Code	Φ x Ht cm	SUR.	Prix HT
Casserole	1,7	79 30 082	16 x 8,5	3	11,65
	2,4	79 30 083	18 x 10	3	13,65
	3,3	79 30 084	20 x 11	3	14,95
Wok	3,9	79 30 104	28 x 8	3	21,85

CHALEUR INSTANTANÉE
en **30** Secondes !



POIGNÉE AMOVIBLE
Double sécurité
Pratique à utiliser



First Inox

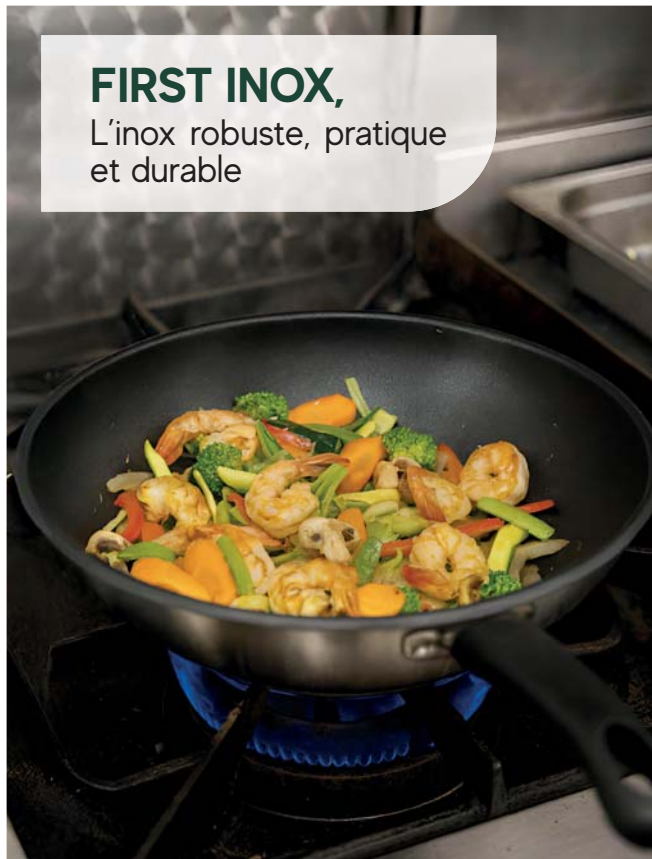

FIRST INOX,

L'inox robuste, pratique et durable



Gaz



Électrique



Vitro-céramique



Induction

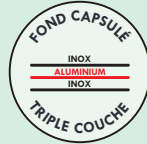

POIGNÉE BAKÉLITE

Non conductrice de la chaleur

- 1 REVÊTEMENT ANTI-ADHÉSIF**
Xylan plus PPG pour les poêles
2 couches



- 2 ACIER INOXYDABLE 430**
Épaisseur 0,4 mm

- 3 FOND INDUCTION**
Fond capsulé 5mm

LA COLLECTION



Désignation	Litres	Code	Φ x Ht cm	SUR.	Prix HT
Wok	3,7	60 20 252	28 x 8	3	16,55
Poêle	1,3	60 20 244	20 x 4,5	3	12,25
	2	60 20 246	24 x 6	3	14,35
	2,9	60 20 247	28 x 7	3	16,85

Désignation	Litres	Code	Φ x Ht cm	SUR.	Prix HT
Casserole	1	60 20 240	14 x 8,5	3	7,55
	1,4	60 20 241	16 x 9	3	8,25
	2	60 20 242	18 x 10	3	8,95
	2,5	60 20 243	20 x 10	3	9,85
Sauteuse	3	60 20 248	24 x 9	3	18,95
Faitout	2,8	60 20 255	20 x 9,5	2	14,25
	5	60 20 256	24 x 13	2	17,55

ALU PRO,

L'aluminium professionnel haute performance, associé à un revêtement céramique performant



98% ALUMINIUM RECYCLÉ 

1 COUCHE EXTÉRIEURE REVÊTEMENT NOIR

2 COUCHE INTERMÉDIAIRE ALUMINIUM PRESSÉ 4mm

3 COUCHE INTÉRIEURE CÉRAMIQUE DOUBLE COUCHE

+ POIGNÉE CHEF MÉTAL RIVETÉ
Ultra résistante, non conductrice de la chaleur

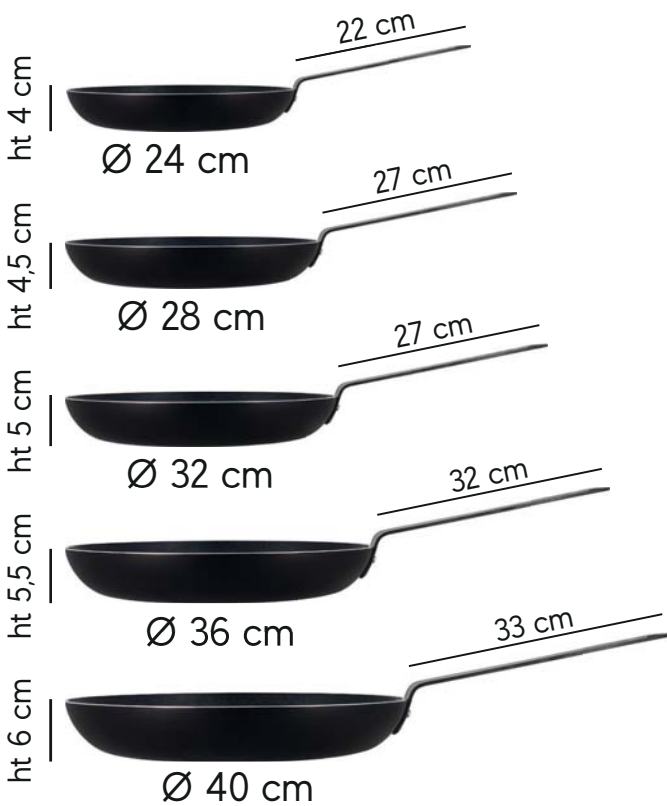

Désignation	Litres	Code	Φ x Ht cm	SUR.	Prix HT
Poêle	1,4	60 21 100	24 x 4	6	15,00
	2,3	60 21 101	28 x 4,5	6	18,60
	3,2	60 21 102	32 x 5	6	23,40
	4,6	60 21 103	36 x 5,5	6	28,20
	6	60 21 104	40 x 6	6	34,20



First Alu

98% ALUMINIUM RECYCLÉ

REVÊTEMENT CÉRAMIQUE

Revêtement anti-adhésif, résistant et facile à nettoyer

FOND TEXTURÉ

Pour une meilleure adhérence des aliments pour une cuisson homogène

POIGNÉE ERGONOMIQUE

En bakélite soudée pour bonne prise en main



FOND ALUMINIUM FORGÉ
Épaisseur 2 mm



Faitout

Code	Litres	Φ x Ht cm	SUR.	Prix HT
60 20 646	2,3	20 x 10	4	13,55
60 20 647	4,3	24 x 12	4	16,95



Casserole

Poêle

Code	Litres	Φ x Ht cm	SUR.	Prix HT
60 20 635	1	20 x 4,2	6	7,85
60 20 636	1,7	24 x 4,8	6	8,85
60 20 637	2,1	26 x 5	6	10,55
60 20 638	2,5	28 x 5	6	11,55
60 20 639	3,1	30 x 5,4	6	12,55

Code	Litres	Φ x Ht cm	SUR.	Prix HT
60 20 611	1,3	16 x 7,8	6	7,85
60 20 612	1,7	18 x 8	6	8,85
60 20 613	2,3	20 x 8,5	6	9,85



Gaz



Électrique



Vitro-
céramique



Induction





Poêle

Désignation	Litres	Code	Φ x Ht cm	SUR.	Prix HT
● Rose	1,1	60 20 920	20 x 4,5	4	16,60
	1,8	60 20 921	24 x 5	4	20,80
	2,7	60 20 922	28 x 5,8	4	23,20
● Crème	1,1	60 20 845	20 x 4,5	4	16,60
	1,8	60 20 846	24 x 5	4	20,80
	2,7	60 20 847	28 x 5,8	4	23,20
● Safran	1,1	60 20 830	20 x 4,5	4	16,60
	1,8	60 20 831	24 x 5	4	20,80
	2,7	60 20 832	28 x 5,8	4	23,20
● Céladon	1,1	60 20 800	20 x 4,5	4	16,60
	1,8	60 20 801	24 x 5	4	20,80
	2,7	60 20 802	28 x 5,8	4	23,20
● Magenta	1,1	60 20 815	20 x 4,5	4	16,60
	1,8	60 20 816	24 x 5	4	20,80
	2,7	60 20 817	28 x 5,8	4	23,20
● Olive	1,1	60 20 875	20 x 4,5	4	16,60
	1,8	60 20 876	24 x 5	4	20,80
	2,7	60 20 877	28 x 5,8	4	23,20



Casserole

Désignation	Litres	Code	Φ x Ht cm	SUR.	Prix HT
● Rose	1,2	60 20 923	16 x 7,5	4	16,60
	1,8	60 20 924	18 x 8,5	4	19,95
	2,8	60 20 925	20 x 11	4	23,20
● Crème	1,2	60 20 848	16 x 7,5	4	16,60
	1,8	60 20 849	18 x 8,5	4	19,95
	2,8	60 20 850	20 x 11	4	23,20
● Safran	1,2	60 20 833	16 x 7,5	4	16,60
	1,8	60 20 834	18 x 8,5	4	19,95
	2,8	60 20 835	20 x 11	4	23,20
● Céladon	1,2	60 20 803	16 x 7,5	4	16,60
	1,8	60 20 804	18 x 8,5	4	19,95
	2,8	60 20 805	20 x 11	4	23,20
● Magenta	1,2	60 20 818	16 x 7,5	4	16,60
	1,8	60 20 819	18 x 8,5	4	19,95
	2,8	60 20 820	20 x 11	4	23,20
● Olive	1,2	60 20 878	16 x 7,5	4	16,60
	1,8	60 20 879	18 x 8,5	4	19,95
	2,8	60 20 880	20 x 11	4	23,20



Wok

Désignation	Litres	Code	Φ x Ht cm	SUR.	Prix HT
● Rose	3,7	60 20 929	28 x 8	4	23,00
● Crème	3,7	60 20 854	28 x 8	4	23,00
● Safran	3,7	60 20 839	28 x 8	4	23,00
● Céladon	3,7	60 20 809	28 x 8	4	23,00
● Magenta	3,7	60 20 824	28 x 8	4	23,00



Sautéuse

Désignation	Litres	Code	Φ x Ht cm	SUR.	Prix HT
● Rose	2,7	60 20 928	24 x 9	2	41,60
● Crème	2,7	60 20 853	24 x 9	2	41,60
● Safran	2,7	60 20 838	24 x 9	2	41,60
● Céladon	2,7	60 20 808	24 x 9	2	41,60
● Magenta	2,7	60 20 823	24 x 9	2	41,60



COUVERCLE
En verre transparent avec bouton bakélite effet bois

ALUMINIUM FORGÉ
épaisseur 2.5 mm

INDUCTION
INDUCTION

VITRO CÉRAMIQUE
GLASS CERAMIC

ELECTRIQUE
ELECTRIC

GAZ
GAS

Tous feux, dont induction

REVÊTEMENT 3 COUCHES
Revêtement anti-adhérent très résistant Skandia Xtreme PPG

**98%
ALUMINIUM,
RECYCLÉ**

PFOA

PFOS

PTFE

Cuisson saine sans PFOA

Faitout Noisette

Faitout Crème

Faitout Safran

Faitout Céladon

Faitout Magenta

Désignation	Litres	Code	Φ x Ht cm	SUR.	Prix HT
● Rose	2,8	60 20 926	20 x 12,5	3	33,20
	5,5	60 20 927	24 x 16	3	49,90
○ Crème	2,8	60 20 851	20 x 12,5	3	33,20
	5,5	60 20 852	24 x 16	3	49,90
● Safran	2,8	60 20 836	20 x 12,5	3	33,20
	5,5	60 20 837	24 x 16	3	49,90

Désignation	Litres	Code	Φ x Ht cm	SUR.	Prix HT
● Céladon	2,8	60 20 806	20 x 12,5	3	33,20
	5,5	60 20 807	24 x 16	3	49,90
● Magenta	2,8	60 20 821	20 x 12,5	3	33,20
	5,5	60 20 822	24 x 16	3	49,90
● Olive	2,8	60 20 881	20 x 12,5	3	33,20
	5,5	60 20 882	24 x 16	3	49,90

**POIGNÉE ERGONOMIQUE**

Poignée bakélite soft touch avec revêtement effet bois

**INDUCTION**

Disque compatible tous feux dont induction

**Crêpière 26 cm / Galettière 32 cm**

Désignation	Litres	Code	Φ x Ht cm	SUR.	Prix HT
● Rose Crêpe	0,7	60 20 930	26 x 2,5	4	24,90
● Galette	0,6	60 20 931	32 x 1,5	4	25,90
● Crème Crêpe	0,7	60 20 855	26 x 2,5	4	24,90
● Galette	0,6	60 20 856	32 x 1,5	4	25,90
● Safran Crêpe	0,7	60 20 840	26 x 2,5	4	24,90
● Galette	0,6	60 20 841	32 x 1,5	4	25,90
● Céladon Crêpe	0,7	60 20 810	26 x 2,5	4	24,90
● Galette	0,6	60 20 811	32 x 1,5	4	25,90
● Magenta Crêpe	0,7	60 20 825	26 x 2,5	4	24,90
● Galette	0,6	60 20 826	32 x 1,5	4	25,90



Cannelle

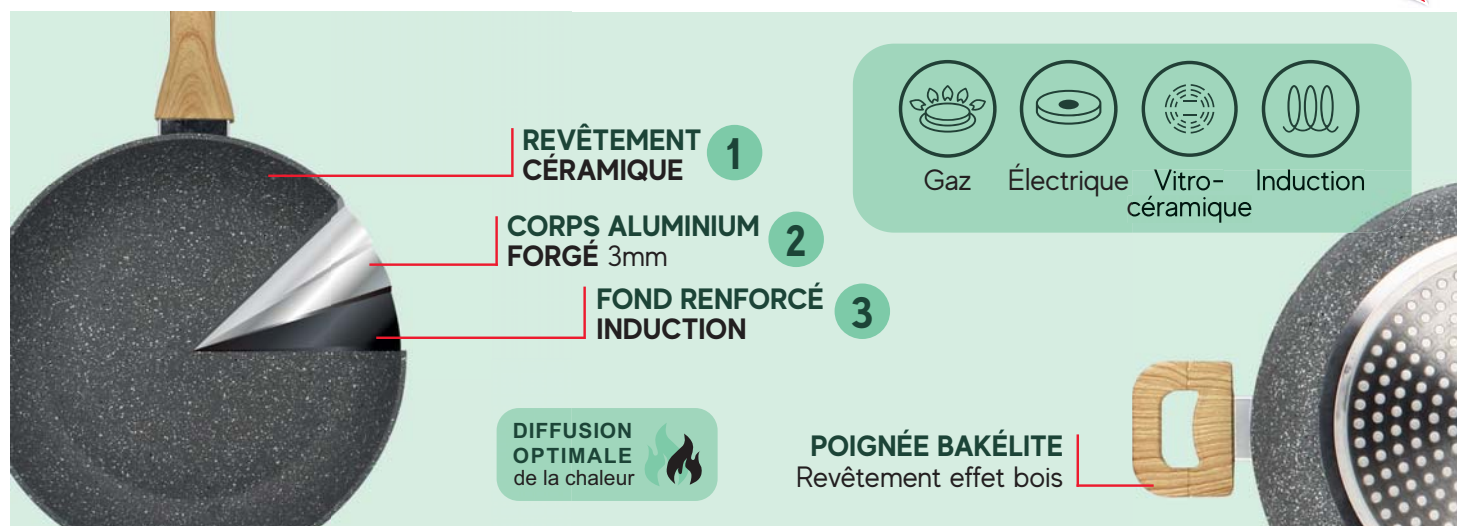

NOUVEAU REVÊTEMENT CÉRAMIQUE

pour une cuisson saine



Wok

Désignation	Litres	Code	Φ x Ht cm	SUR.	Prix HT
Wok	3,5	60 20 038	28 x 8	3	19,55



Poêle

Désignation	Litres	Code	Φ x Ht cm	SUR.	Prix HT
Poêle	1,6	60 20 063	24 x 5,5	3	14,25
	2,3	60 20 064	28 x 6	3	17,55
	3	60 20 065	30 x 6	3	21,65



Sauteuse avec couvercle

Désignation	Litres	Code	Φ x Ht cm	SUR.	Prix HT
Sauteuse	2,2	60 20 039	24 x 10	2	22,45
	3,6	60 20 040	28 x 9	2	32,85

Cerise

1 NOUVEAU REVÊTEMENT CÉRAMIQUE

Cuisson saine et sans accroche

POIGNÉE BAKÉLITE
Effet métallisé rouge

CORPS ALUMINIUM
Effet métallisé rouge **2**
2,5 mm

FOND INDUCTION **3**

Gaz



Électrique

Vitro-
céramique

Induction



Poêle

Désignation	Litres	Code	Φ x Ht cm	SUR.	Prix HT
Poêle	0,9	60 20 574	20 x 4	3	9,50
	1,4	60 20 575	24 x 4,5	3	12,50
	2,2	60 20 576	28 x 5	3	16,50
	3,5	60 20 577	32 x 6	3	21,50



Casserole

Désignation	Litres	Code	Φ x Ht cm	SUR.	Prix HT
Casserole	0,9	60 20 570	14 x 7	3	9,50
	1,3	60 20 571	16 x 8	3	10,50
	2,3	60 20 572	18 x 8,5	3	11,50
	2,5	60 20 573	20 x 9	3	13,50



Sauteuse avec couvercle

Désignation	Litres	Code	Φ x Ht cm	SUR.	Prix HT
Sauteuse	2,1	60 20 580	24,5 x 11	2	17,65



Wok

Désignation	Litres	Code	Φ x Ht cm	SUR.	Prix HT
Wok	3	60 20 581	28 x 8	3	17,65



Crêpière

Désignation	Code	Φ x Ht cm	SUR.	Prix HT
Crêpière	60 20 578	25 x 1,7	3	11,50



Faitout avec couvercle

Désignation	Litres	Code	Φ x Ht cm	SUR.	Prix HT
Faitout	4,2	60 20 579	24 x 17	4	23,50



Poêles

Acier inoxydable 18/10



Triply
p.176
Ø 20/24/28/32 cm



Trinox
p.178
Ø 24/28/30 cm



Trinox Revêtu
p.179
Ø 20/24/28/30 cm



Inox Pro
p.280
Ø 20/24/28/30 cm

Acier inoxydable 18/10



Easynox
p.182
Ø 20/24/28 cm



Iris Inox
p.184
Ø 20/24/28 cm

Acier inoxydable 18/0



First Inox
p.185
Ø 20/24/28 cm



Alu Pro
p.186
Ø 24/28/32/36/40 cm

Aluminium revêtement Céramique

Aluminium revêtement Céramique



First Alu
p.187
Ø 20/24/26/28/30 cm



Colorama
p.188
Ø 20/24/28 cm



Cannelle
p.190
Ø 20/24/28/30 cm



Cerise
p.191
Ø 20/24/28/32 cm

Poêle à poisson

Acier inoxydable 18/10



Inox Pro
p.180
37,5 cm

Woks

Acier inoxydable 18/10



Triply
p.176
Ø 24/28 cm



Trinox revêtu
p.179
Ø 28 cm



Inox Pro
p.180
Ø 30 cm



Easynox
p.182
Ø 28 cm



Iris Inox
p.184
Ø 28 cm

Acier inoxydable 18/0



First Inox
p.185
Ø 28 cm



Colorama
p.188
Ø 28 cm



Cannelle
p.190
Ø 28 cm



Cerise
p.191
Ø 28 cm

Aluminium revêtement Céramique

Crêpières

Aluminium revêtement Céramique



Colorama
p.189
Ø 26/32 cm



Cerise
p.191
Ø 25 cm

Faitouts

Acier Inoxydable 18/10



Triply
p.176
Ø 24 cm



Trinox
p.178
Ø 20/24 cm



Trinox Revêtu
p.179
Ø 20/24 cm



Inox Pro
p.180
Ø 24 cm



Easynox
p.182
Ø 24 cm

Acier Inoxydable 18/0

Aluminium revêtement Céramique



First Inox
p.185
Ø 24 cm



First alu
p.187
Ø 20/24 cm



Colorama
p.189
Ø 20/24 cm



Cerise
p.191
Ø 24 cm

Sauteuses

Acier Inoxydable 18/10

Acier Inoxydable 18/0



Triply
p.176
Ø 24 cm



Trinox Revêtu
p.179
Ø 24 cm



Inox Pro
p.180
Ø 28 cm



First Inox
p.185
Ø 24 cm

Aluminium revêtement Céramique



Colorama
p.188
Ø 24 cm



Cannelle
p.190
Ø 24/28 cm



Cerise
p.191
Ø 24 cm

Casseroles

Acier Inoxydable 18/10



Triply
p.176
Ø 16/18/20 cm



Trinox
p.178
Ø 18/20 cm



Trinox Revêtu
p.179
Ø 14/16 cm



Inox Pro
p.180
Ø 14/16/18/20/24 cm

Acier Inoxydable 18/10

Acier Inoxydable 18/0

Aluminium revêtement Céramique



Easynox
p.182
Ø 16/18/20 cm



Iris Inox
p.184
Ø 16/18/20 cm



First Inox
p.185
Ø 14/16/18/20 cm



First Alu
p.187
Ø 16/18/20 cm

Aluminium revêtement Céramique



Colorama
p.188
Ø 16/18/20 cm



Cerise
p.191
Ø 14/16/18/20 cm

Colette & Volcano



Four



Gaz



Électrique



Vitro-céramique



Induction



**COCOTTE EN FONTE
DIFFUSION UNIFORME
DE LA CHALEUR**

**BOUTON
ACIER INOXYDABLE**



FONTE ÉMAILLÉE
Épaisseur 2.5 mm

MAINTIENT L'HUMIDITÉ
Pour une cuisson savoureuse

COUVERCLE AJUSTÉ
Pour retenir la vapeur

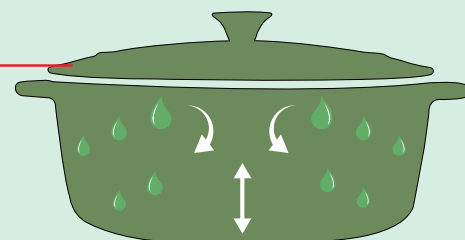

**INTÉRIEUR
COUVERCLE**

Avec picots pour
un maintien de la
vapeur d'eau

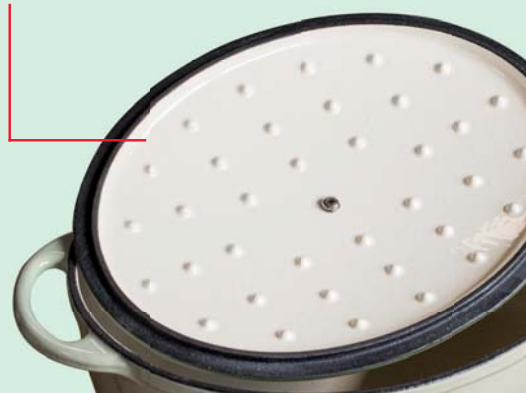

Cocotte ovale avec couvercle

Désignation	Code	Ccl	L x l x Ht cm	SUR.	Prix HT
Cocotte ovale rouge	60 20 101	400	27 x 21 x 11	2	41,55
	60 20 102	650	33 x 25 x 12,5	1	63,25
	60 20 103	900	36 x 27 x 14	1	78,85



Cocotte ronde avec couvercle

Désignation	Code	Ccl	Φ x Ht cm	SUR.	Prix HT
Cocotte ronde rouge	60 20 105	700	29 x 13	1	58,35



Cocotte ovale avec couvercle

Désignation	Code	Ccl	L x l x Ht cm	SUR.	Prix HT
Cocotte ovale verte	60 20 080	400	34,5 x 22 x 17	1	34,20



Tajines & Couscoussiers



Tajine 24 cm



Tajine 24 cm

Désignation	Litres	Code	Φ x Ht cm	SUR.	Prix HT
Céladon	1,6	60 20 041	24 x 21	4	27,00
Safran	1,6	60 20 047	24 x 21	4	27,00

Désignation	Litres	Code	Φ x Ht cm	SUR.	Prix HT
Magenta	1,6	60 20 042	24 x 21	4	27,00
Rose	1,6	60 20 046	24 x 21	4	27,00

ALUMINIUM
Effet marbre

PARTIE SUPÉRIEURE

Passoire avec bas percé pour laisser passer la vapeur pour la cuisson du couscous



Four



Gaz



Électrique

Vitro-
céramique

Induction

COUVERCLE
VERREALUMINIUM FORGÉ
Épaisseur 2.5 mmPOIGNÉES EN BAKÉLITE
Soudées

Couscoussier 24 cm

Désignation	Litres	Code	Φ x Ht cm	SUR.	Prix HT
Couscoussier	9	60 20 033	24 x 30,5	2	41,55

COUVERCLE CÉRAMIQUE
Coloris jauneALUMINIUM FORGÉ
Épaisseur 2.5 mm

Tajine 30 cm

Désignation	Litres	Code	Φ x Ht cm	SUR.	Prix HT
Tajine	2,5	60 20 032	30 x 23	2	41,55



**COUVERCLE
VERRE**



Couscoussier inox

Code	Litres	Φ x Ht cm	SUR.	Prix HT
46 15 450	10	24 x 32	6	29,55



Marmite inox

Code	Litres	Φ x Ht cm	SUR.	Prix HT
46 15 455	9	24 x 20	2	27,95
46 15 451	17	30 x 40	2	41,95

CORPS INOX
Durable, résistant à la rouille et à la corrosion
Diffusion optimale de la chaleur

POIGNÉE
Poignée rivetée en inox
qui reste froide



Bassine à confiture

Code	Litres	Φ x Ht cm	SUR.	Prix HT
46 15 452	17	41 x 17	6	24,95



Autocuiseur Authentique

Désignation	Litres	Code	Φ x Ht cm	SUR.	Prix HT
Autocuiseur*	6	42 14 240	24 x 20	1	145,00



Harry



Plat rectange inox

Désignation	Code	L	L x l x Ht cm	SUR.	Prix HT
Plat rectange Inox	46 15 220	3	30 x 21 x 5	6	8,55
	46 15 221	4	35 x 25 x 6	6	11,25
	46 15 222	5	40 x 28 x 6	6	11,85



Amandine



Plat à rôtir acier carbone

Code	L x l x Ht cm	SUR.	Prix HT
60 20 003	43,5 x 29 x 6	6	10,25



Couverture inox

Code	Φ cm	SUR.	Prix HT
46 15 210	21	6	2,65
46 15 211	25	6	3,32
46 15 212	30	6	4,17



Couverture silicone

Code	L x l x Ht cm	SUR.	Prix HT
60 21 990	16/18/20	6	4,90
60 21 991	22/24/26	6	5,50
60 21 992	26/28/30	6	6,90

Marmite à moules



Marmite à moules Noire

Marmite à moules Noire inscription "Moules"

Marmite à moules Rouge

Marmite à moules Blanche

Désignation	Code	Litres	Ø x Ht cm	SUR.	Prix HT
Marmite Noire	36 45 567	2,7	18 x 15,5	6	8,95
Marmite 'Moules'	36 45 563	2,7	18 x 15,5	6	9,95
	36 45 564	5	24 x 17,5	6	14,55

Désignation	Code	Litres	Ø x Ht cm	SUR.	Prix HT
Marmite Rouge	36 45 562	2,7	18 x 15,5	6	11,10
Marmite Blanche	36 45 561	2,7	18 x 15,5	2	11,95

ACIER ÉMAILLÉ
Épaisseur 0,6 mm

DIFFUSION OPTIMALE
de la chaleur

Gaz Électrique Vitro-céramique Induction



Marmite à moules en Acier Inoxydable

Code	Litres	Ø x Ht cm	SUR.	Prix HT
60 20 360	2,7	18 x 19,5	4	11,40

Friteuse



Panier friteuse



Friteuse du nord émail avec panier



Poêle à frire émail avec panier



Friteuse émail noire avec panier et couvercle

Désignation	Litres	Code	L x l x Ht cm	SUR.	Prix HT
Panier friteuse		36 45 025	24 x 9,5	12	3,95
Poêle à frire	2,7	36 45 749	44 x 26 x 10,5	6	9,95

Désignation	Litres	Code	Ø x Ht cm	SUR.	Prix HT
Friteuse du nord	6,8	36 45 575	28 x 20	6	18,69
Friteuse avec couvercle	2,6	36 45 579	20 x 11,5	6	9,55
	5	36 45 580	26 x 11,5	6	18,71

Octave



DESIGN ÉLÉGANT
Look tendance, intérieur brillant, extérieur mat

PLAT EN GRÈS
Résistant aux chocs thermiques et aux rayures



CUISSON LENTE
Rétention thermique exceptionnelle

3 COLORIS TENDANCES
Terracotta, Crème et Kaki



Compatible congélateur, micro-ondes, lave-vaisselle & four



Plat rectangulaire (x4 tailles)

Désignation	Litres	Code	L x l x Ht cm	SUR.	Prix HT
● Beige	0,5	33 56 125	22 x 13,5 x 4,5	6	5,75
	1,1	33 56 130	27 x 16,5 x 5,8	6	9,95
	2,2	33 56 135	33 x 20 x 6,5	6	14,55
● Terracotta	3,3	33 56 140	38 x 23 x 8	6	21,95
	0,5	33 56 126	22 x 13,5 x 4,5	6	5,75
	1,1	33 56 131	27 x 16,5 x 5,8	6	9,95
● Kaki	2,2	33 56 136	33 x 20 x 6,5	6	14,55
	3,3	33 56 141	38 x 23 x 8	6	21,95
	0,5	33 56 127	22 x 13,5 x 4,5	6	5,75
● Kaki	1,1	33 56 132	27 x 16,5 x 5,8	6	9,95
	2,2	33 56 137	33 x 20 x 6,5	6	14,55
	3,3	33 56 142	38 x 23 x 8	6	21,95



Plat ovale



Plat carré



Plat rond



Ramequin 12 cm



Ramequin 9 cm

Désignation	Code	Ccl	L x l x Ht cm	SUR.	Prix HT
Plat ovale	● 33 56 161	95	27 x 17 x 5,5	6	9,35
	● 33 56 162	95	27 x 17 x 5,5	6	9,35
Plat carré	● 33 56 165	120	24 x 19 x 5,8	6	9,95
	● 33 56 166	120	24 x 19 x 5,8	6	9,95
	● 33 56 167	120	24 x 19 x 5,8	6	9,95

Désignation	Code	Ccl	Φ x Ht cm	SUR.	Prix HT
Plat rond	● 33 56 170	95	20 x 5,8	6	8,95
	● 33 56 170	95	20 x 5,8	6	8,95
	● 33 56 170	95	20 x 5,8	6	8,95
Ramequin 12 cm	● 33 56 150	40	12 x 6	6	3,65
	● 33 56 151	40	12 x 6	6	3,65
	● 33 56 152	40	12 x 6	6	3,65
Ramequin 9 cm	● 33 56 145	18	9 x 5	12	1,85
	● 33 56 146	18	9 x 5	12	1,85
	● 33 56 147	18	9 x 5	12	1,85



Plat grille



Tourtière



Moule à cake

Code	Ccl	L x l x Ht cm	SUR.	Prix HT
● 33 56 155	84	26,5 x 15 x 4,5	6	8,95
● 33 56 156	84	26,5 x 15 x 4,5	6	8,95
● 33 56 157	84	26,5 x 15 x 4,5	6	8,95

Code	Ccl	Φ x Ht cm	SUR.	Prix HT
● 33 56 180	180	29 x 4,5	6	11,45
● 33 56 181	180	29 x 4,5	6	11,45
● 33 56 182	180	29 x 4,5	6	11,45



Code	Ccl	L x l x Ht cm	SUR.	Prix HT
● 33 56 185	180	27 x 13,5 x 8	6	7,25
● 33 56 186	180	27 x 13,5 x 8	6	7,25
● 33 56 187	180	27 x 13,5 x 8	6	7,25

Amandine Colorama



REVÊTEMENT CÉRAMIQUE CÉLADON
Cuisson sans accroche et nettoyage facile

ACIER CARBONE
Épaisseur 0,6mm

  Compatible four & lave-vaisselle

3 TAILLES DISPONIBLES

- 35x27 cm
- 40x28 cm
- 45x30 cm



Plat à rotir Céladon

Désignation	Code	L x l x Ht cm	SUR.	Prix HT
Plat Céladon	60 21 073	35 x 27 x 6,8	6	4,95
	60 21 074	40 x 28 x 7	6	5,50
	60 21 075	45 x 30 x 7,5	6	5,95



Moule à manqué Noisette

Code	Ø x Ht cm	SUR.	Prix HT
60 20 787	26 x 5	6	4,35



Moule à tarte Céladon

Code	Ø x Ht cm	SUR.	Prix HT
60 20 788	28 x 3	6	4,25



Moule à tarte Noisette

Code	Ø x Ht cm	SUR.	Prix HT
60 20 789	30 x 3	6	4,70



Moule à charnière Magenta

Code	Ø x Ht cm	SUR.	Prix HT
60 20 784	22 x 7	6	5,50



Moule à charnière Safran

Code	Ø x Ht cm	SUR.	Prix HT
60 20 785	24 x 6,8	6	5,60



Moule à charnière Olive

Code	Ø x Ht cm	SUR.	Prix HT
60 20 786	26 x 7	6	6,05



Moule à cake Crème

Code	L x l x Ht cm	SUR.	Prix HT
60 20 783	31 x 11,5 x 7,5	6	4,65

Angélique

Acier Inoxydable

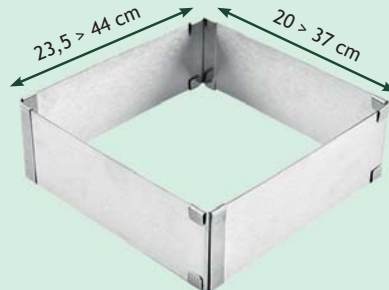

Cadre extensible rectangulaire

Code	L x l x Ht cm	SUR.	Prix HT
60 20 023	23,5>44 x 20>37 x 5	12	8,29



Cadre extensible rond

Code	Ø x Ht cm	SUR.	Prix HT
60 20 024	16>30 x 17	12	8,29

Amandine

La gamme Amandine, ce sont des moules solides et durables avec un **revêtement anti-adhésif** une couche Goldenflon



ACIER CARBONE
Épaisseur 0,4mm
Pour une cuisson homogène



Compatible congélateur, four & lave-vaisselle



SYSTÈME DE CHARNIÈRE
Pour un démoulage facile et rapide en un clic

Moule à charnière rond



Moule à charnière carré

Désignation	Code	L x l x Ht cm	SUR.	Prix HT
Moule à charnière rond	60 20 757	14 x 6,8	6	3,85
	60 20 758	18 x 6,2	6	4,55
	60 20 752	24 x 6,8	6	4,55

Désignation	Code	L x l x Ht cm	SUR.	Prix HT
Moule à charnière carré	60 20 704	26 x 26 x 6,5	6	5,95



Plaque au four



Plaque à pizza



Moule à tarte rectangle



Moule à cake

Désignation	Code	L x l x Ht cm	SUR.	Prix HT
Plaque au four	60 20 745	38 x 27 x 2	6	3,95
Plaque à pizza	60 20 761	33 x 33 x 1,5	6	4,50

Désignation	Code	L x l x Ht cm	SUR.	Prix HT
Moule rectangle	60 20 749	35,5 x 13 x 2,5	6	5,25
Moule à cake	60 20 755	30,5 x 11,5 x 8	6	3,55

Amandine



Moule à manqué carré



Moule à manqué rond



Moule à tarte rond



Moule à tarte rond perforé

Désignation	Code	Φ x Ht cm	SUR.	Prix HT
Moule carré	60 20 756	21 x 4,5	6	3,05
Moule rond	60 20 751	26 x 5	6	3,55

Désignation	Code	Φ x Ht cm	SUR.	Prix HT
Moule tarte	60 20 754	32 x 3	6	4,25
Moule tarte perforé	60 20 753	28 x 3	6	3,85
Moule tarte perforé	60 20 748	32 x 3	6	4,55



Moule à 12 muffins



Moule à 6 muffins



Panier cuisson



Moule cuisson

Désignation	Code	L x l x Ht cm	SUR.	Prix HT
Moule à 12 muffins	60 20 747	35 x 26,5 x 3	6	6,55
Moule à 6 muffins	60 20 746	26,5 x 18 x 3	6	3,95

Désignation	Code	Ø x Ht cm	SUR.	Prix HT
Panier cuisson	60 20 672	20 x 7	6	3,60
Moule cuisson	60 20 671	20 x 2,5	2,5	1,95

Accessoires Silicone

MOULE SILICONE
Flexible, anti-adhésif et résistant à la chaleur



Plaque génoise

Code	L x l x Ht cm	SUR.	Prix HT
60 20 030	36 x 26,5 x 1	12	6,85

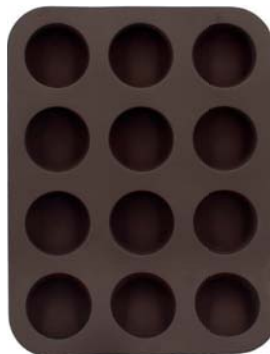

Moule à 12 muffins

Code	L x l x Ht cm	SUR.	Prix HT
60 20 773	25 x 19 x 2,5	12	10,79



Moule à 6 financiers

Code	L x l x Ht cm	SUR.	Prix HT
60 20 774	26,5 x 16 x 2,5	12	9,96

Bacs gastronormes en inox

EMPILABLE



ACIER INOXYDABLE 18/10

Robuste et facile à nettoyer

UNE GRANDE RÉSISTANCE

Résiste aux chocs thermiques (changement de températures rapides) et aux températures extrêmes (jusqu'à 400°)



Compatible congélateur, lave vaisselle et four.

USAGE PROFESSIONNEL

Bacs adaptés pour la restauration et l'hôtellerie. Ils s'adaptent aux équipements normés : armoires réfrigérées, chariots de transport, présentoirs, fours, éviers, ...



A. Bac 1/1 : 53 x 32,5 cm

Désignation	Code	Litres	Profondeur cm	SUR.	Prix HT
A. Bac 1/1	46 10 450	5,5	prof 4	6	14,71
	46 10 451	7,2	prof 5,5	6	16,46
	46 10 452	8,5	prof 6,5	6	16,41
	46 10 453	13,3	prof 10	6	22,11
	46 10 454	20,6	prof 15	6	30,21
	46 10 455	30	prof 20	6	34,70
	46 10 489	8,5	prof 6,5 perforé	6	18,86
	46 10 490	13,3	prof 10 perforé	6	24,07



B. Bac 1/2 : 26,5 x 32,5 cm

Désignation	Code	Litres	Profondeur cm	SUR.	Prix HT
B. Bac 1/2	46 10 457	3,2	prof 5,5	12	9,44
	46 10 458	4,2	prof 6,5	12	10,01
	46 10 459	8	prof 10	6	14,04



C. Bac 1/9 : 17,6 x 10,8 cm

Code	Litres	Profondeur cm	SUR.	Prix HT
46 10 476	0,7	prof 6,5	48	4,00
46 10 477	0,85	prof 10	48	6,53



D. Bac 1/3 : 17,6 x 32,5 cm

Code	Litres	Profondeur cm	SUR.	Prix HT
46 10 464	2,5	prof 6,5	18	8,02
46 10 465	3,8	prof 10	18	11,30
46 10 466	5,9	prof 15	18	15,48
46 10 467	8,1	prof 20	6	17,70



E. Bac 1/4 : 26,5 x 16,2 cm

Code	Litres	Profondeur cm	SUR.	Prix HT
46 10 468	1,9	prof 6,5	6	6,99
46 10 470	4,1	prof 15	1	13,88



F. Bac 1/6 : 17,6 x 16,2 cm

Code	Litres	Profondeur cm	SUR.	Prix HT
46 10 473	1,6	prof 10	36	7,95
46 10 474	2,5	prof 15	36	9,98



G. Couverture avec poignée

Code	Bac adapté	L x l cm	SUR.	Prix HT
46 10 483	1/9	17,6 x 10,8	48	2,25
46 10 482	1/6	17,6 x 16,2	36	2,85
46 10 481	1/4	26,5 x 16,2	24	5,20
46 10 480	1/3	32,5 x 17,6	18	5,50
46 10 479	1/2	32,5 x 26,5	12	7,15
46 10 478	1/1	53 x 32,5	6	14,45



Pince inox bac

Code	L x l x Ht cm	SUR.	Prix HT
46 10 492	22 x 60 x 45	12	18,55

Bacs en polypropylène

HAUTE RÉSISTANCE

Plats conçus en polypropylène supportant des températures de -40°C à 70°C.

TRANSPARENCE

Identification du contenu très rapidement grâce à la transparence.



Compatible congélateur, lave vaisselle.



H. Bac 1/1 : 53 x 32,5 cm

Désignation	Code	Litres	Profondeur cm	SUR.	Prix HT
H. Bac 1/1	46 10 550	8,5	prof 6,5	6	11,85
	46 10 551	12,9	prof 10	6	14,05
	46 10 552	19,5	prof 15	6	17,75
	46 10 553	25,9	prof 20	6	22,45



I. Bac 1/2 : 26,5 x 32,5 cm

Désignation	Code	Litres	Profondeur cm	SUR.	Prix HT
I. Bac 1/2	46 10 554	3,9	prof 6,5	12	6,10
	46 10 555	5,9	prof 10	12	8,65
	46 10 556	8,8	prof 15	12	10,20



J. Bac 1/3 : 17,6 x 32,5 cm

Désignation	Code	Litres	Profondeur cm	SUR.	Prix HT
J. Bac 1/3	46 10 558	2,4	prof 6,5	18	4,90
	46 10 559	3,8	prof 10	18	5,85
	46 10 561	5,1	prof 15	18	7,25
	46 10 562	6,9	prof 20	18	8,85



K. Bac 1/4 : 26,5 x 16,2 cm

Désignation	Code	Litres	Profondeur cm	SUR.	Prix HT
K. Bac 1/4	46 10 564	2,4	prof 10	24	5,55
	46 10 565	3,7	prof 15	24	5,95



L. Bac 1/6 : 17,6 x 16,2 cm

Code	Litres	Profondeur cm	SUR.	Prix HT
46 10 566	1	prof 6,5	36	3,75
46 10 567	1,6	prof 10	36	4,05
46 10 568	2,2	prof 15	36	5,65



M. Bac 1/9 : 17,6 x 10,8 cm

Code	Litres	Profondeur cm	SUR.	Prix HT
46 10 569	0,9	prof 10	48	3,75



N. Couverture

Code	Bac adapté	L x l cm	SUR.	Prix HT
46 10 575	1/9	17,6 x 10,8	48	1,95
46 10 574	1/6	17,6 x 16,2	36	2,15
46 10 573	1/4	26,5 x 16,2	24	3,30
46 10 572	1/3	32,5 x 17,6	18	3,95
46 10 571	1/2	32,5 x 26,5	12	5,35
46 10 570	1/1	53 x 32,5	6	8,95



Plat ovale classique



Plat gratin



Plat rectangle

Désignation	Ccl	Code	L x l x Ht cm	SUR.	Prix HT
Plat ovale	200	75 41 456	30 x 21 x 6,2	4	6,30
	300	75 41 457	35 x 24 x 6,5	6	7,73
	400	75 41 458	39 x 27 x 6,5	4	9,25
Plat gratin	50	75 41 460	19 x 14 x 4	6	3,75
	80	75 41 462	25 x 20 x 5,5	6	4,97

Désignation	Ccl	Code	L x l x Ht cm	SUR.	Prix HT
Plat rectangle	150	14 59 003	32 x 20 x 5	6	5,75
	200	14 59 004	35 x 23 x 5,5	6	7,15
	250	14 59 005	39 x 23 x 5,5	6	8,50



Plat carré

Code	Ccl	L x l x Ht cm	SUR.	Prix HT
14 59 009	100	20 x 17 x 6	10	5,68

PLAT EN VERRE

Verre borosilicate, haute résistance à la chaleur, convient à un usage au four, au micro-ondes, au réfrigérateur et au congélateur



Jatte

Code	Litres	Φ x Ht cm	SUR.	Prix HT
14 59 039	3	24 x 13	6	7,67



Jate expert bowl

Code	Litres	L x l x Ht cm	SUR.	Prix HT
14 59 040	4,2	29 x 27 x 15	3	13,54



Moule à cake

Code	Ccl	L x l x Ht cm	SUR.	Prix HT
75 41 473	150	28 x 26 x 12	6	7,21



Moule à tarte

Code	Ccl	Φ x Ht cm	SUR.	Prix HT
75 41 472	250	27 x 3,5	8	6,00



Accessoires Airfryer



Plat rond



Plat rectangle



Plat carré

Désignation	Code	Ccl	L x l x Ht cm	SUR.	Prix HT
Plat rond	14 50 140	100	20 x 18 x 7	4	9,55
	14 50 144	230	26 x 23 x 8	5	10,75
Plat rectangle	14 50 143	120	23 x 15 x 7	8	10,75
Plat carré	14 50 141	100	20 x 17 x 6	10	9,55
	14 50 142	220	25 x 22 x 7	8	10,75



Slow Cook



Cocotte ovale classic

Désignation	Ccl	Code	L x l x Ht cm	SUR.	Prix HT
Cocotte ovale	440	14 50 076	38 x 23 x 15	3	28,81

Slow Cook



Cocotte rectangle

Désignation	Ccl	Code	L x l x Ht cm	SUR.	Prix HT
Cocotte rectangle	670	14 50 040	37 x 22 x 14	3	30,80

4 en 1



Cocotte ronde

Désignation	Ccl	Code	L x l x Ht cm	SUR.	Prix HT
Cocotte ronde	140	14 50 098	21 x 18 x 8,5	3	14,33
	210	14 50 096	24 x 20 x 10	3	12,46
	300	14 50 094	27 x 23 x 11	3	10,56
	350	14 50 074	32 x 27 x 14	3	22,53

Ô Cuisine



Cocotte ovale

Désignation	Ccl	Code	L x l x Ht cm	SUR.	Prix HT
Cocotte ovale	400	14 59 018	34 x 22 x 13,5	3	14,00



Cocotte ronde

Désignation	Ccl	Code	L x l x Ht cm	SUR.	Prix HT
Cocotte ronde	100	75 41 469	21 x 17,8 x 8,3	3	7,59
	160	75 41 465	23,9 x 20,2 x 9,8	3	8,79
	250	75 41 466	23 x 28 x 13	3	9,46





UNE GRANDE RÉSISTANCE

Résiste aux chocs thermiques (changement de températures rapides) et aux températures extrêmes (jusqu'à 400°)



Cook & freeze



Plat rectangle

Désignation	Code	Ccl	L x l x Ht cm	SUR.	Prix HT
Plat rectangle	14 51 004	80	19 x 14 x 4	6	9,33
	14 51 005	150	22 x 17 x 6	6	12,48
	14 51 006	260	25 x 19 x 8	6	15,60
	14 51 007	400	27 x 22 x 9	3	17,47



Plat rond

Désignation	Code	Ccl	L x l x Ht cm	SUR.	Prix HT
Plat rond	14 51 057	60	12 x 6	8	?
	14 51 058	110	15 x 9	4	?

Cook & heat



Compatible congélateur, micro-ondes, lave vaisselle et four (sauf couvercle)



Plat rectangle

Désignation	Code	Ccl	L x l x Ht cm	SUR.	Prix HT
Plat rectangle	14 51 023	40	17 x 10 x 5	5	9,10
	14 51 024	110	23 x 15 x 6	5	12,18
	14 51 025	250	28 x 20 x 8	4	16,11



Plat carré

Désignation	Code	Ccl	L x l x Ht cm	SUR.	Prix HT
Plat carré	14 51 022	220	25 x 22 x 7	4	16,11
Plat rond	14 51 018	110	20 x 18 x 7	5	12,18



Plat rond

COUVERCLE

Couvercle à valves breveté

Let's Share



Plat carré

Désignation	Code	Ccl	L x l x Ht cm	SUR.	Prix HT
Plat carré	14 50 010	230	29 x 23 x 7	6	15,82



Plat ovale

Désignation	Code	Ccl	L x l x Ht cm	SUR.	Prix HT
Plat ovale	14 50 015	200	30 x 21 x 7	4	13,30
	14 50 016	280	35 x 24 x 6	6	17,10
	14 50 017	450	39 x 27 x 7	4	20,92



Plat rectangle

Désignation	Code	Ccl	L x l x Ht cm	SUR.	Prix HT
Plat rectangle	14 50 011	140	27 x 17 x 6	6	12,00
	14 50 012	210	31 x 20 x 6	6	15,19
	14 50 013	290	35 x 23 x 6	6	18,42
	14 50 014	380	39 x 25 x 7	6	21,54



Pyrex



PYREX



LE VERRE PYREX® EST UNIQUE

En borosilicate de qualité supérieure, d'une extrême résistance aux chocs thermiques et mécaniques. Tous les produits de la gamme en verre Pyrex® sont garantis 10 ans



Essentials



Plat ovale

Code	Ccl	L x l x Ht cm	SUR.	Prix HT
14 50 035	65	21 x 13 x 5	10	7,46
14 50 036	160	26 x 18 x 6	6	9,99



Plat lasagne Cook & Enjoy

Code	Ccl	L x l x Ht cm	SUR.	Prix HT
14 50 032	260	35 x 23 x 5	6	13,75
14 50 033	370	40 x 28 x 6	6	18,77



Panier vapeur

Code	Ccl	Φ x Ht cm	SUR.	Prix HT
14 50 082	400	24 x 7	6	15,19

Cook & Enjoy



Moule à manqué

Code	Ccl	Φ x Ht cm	SUR.	Prix HT
14 50 155	210	26 x 6	6	11,54

Iconics



Jatte

Code	Ccl	Φ x Ht cm	SUR.	Prix HT
14 50 116	50	14 x 8	12	3,76
14 50 117	100	17 x 10	12	5,30
14 50 118	200	21 x 11	6	7,35
14 50 119	300	24 x 13	6	9,37

Cook & Enjoy



Moule à soufflé

Code	Ccl	Φ x Ht cm	SUR.	Prix HT
14 50 158	250	21 x 9,9	4	11,54



Cook & Enjoy



Moule à cake

Code	Ccl	L x l x Ht cm	SUR.	Prix HT
14 50 156	150	28 x 11 x 8	4	9,73
14 50 157	170	31 x 12 x 8	4	11,54

Iconics



Moule à tarte

Code	Ccl	Φ x Ht cm	SUR.	Prix HT
14 50 151	110	25 x 3,49	6	9,73
14 50 152	140	28 x 3,65	6	11,54
14 50 153	180	31 x 3,5	6	13,40

Cristal



Lot 2 plats carrés

Désignation	Code	L x l x Ht cm	SUR.	Prix HT
Lot 2 plats carrés	16 92 037	22 x 22 x 5 28 x 28 x 6	4	10,95



Lot 2 plats ovales

Désignation	Code	L x l x Ht cm	SUR.	Prix HT
Lot 2 plats ovales	16 92 036	26 x 18 x 6 35 x 25 x 5	4	10,95



Lot 2 plats à tartes

Désignation	Code	Φ x Ht cm	SUR.	Prix HT
Lot 2 plats à tartes	16 92 038	26 x 4 32 x 5	4	10,95



Cocotte

Désignation	Ccl	Code	L x l x Ht cm	SUR.	Prix HT
Cocotte	510	16 90 025	35,5 x 20 x 15	4	10,85



PLAT EN VERRE

Verre borosilicate, convient à un usage au four, au micro-ondes, au réfrigérateur et au congélateur



So Urban

Parfaitement empilables, et ultra fonctionnelles pour l'optimisation du rangement et des présentations. Verre trempé : Haute résistance thermique et mécanique. Passe au micro-ondes. Fond et couvercle conçus pour lavages en lave-vaisselle industriel. Couvercle en polyéthylène.

Collection 2025

Désignation	Ccl	Code	Φ x Ht cm	SUR.	Prix HT
Coupelle seule S	37	75 16 219	11 x 7,3	24	1,51
Couvercle S		75 16 235	11 x 1,2	24	0,94
Coupelle + couvercle S	37	75 16 218	11 x 7,5	24	2,88
Coupelle seule M	80	75 16 233	14 x 8,8	24	2,58
Couvercle M		75 16 236	14,5 x 1,2	24	1,09
Coupelle + couvercle M	80	75 16 231	14,5 x 9	24	4,24
Coupelle seule L	110	75 16 256	17 x 7,1	12	4,05
Couvercle L		75 16 243	17,5 x 1,2	12	1,59
Coupelle + couvercle L	110	75 16 257	17,5 x 7,5	12	6,67



Food box

Boite en verre trempé transparent extra résistant. Hermétique, pas de dégradation du goût, ni de l'odeur des aliments. Facile à stocker, les boîtes s'empilent à condition de laisser le couvercle. Couvercle translucide neutre.



Boite hermétique rectangle

Désignation	Ccl	Code	L x l x Ht cm	SUR.	Prix HT
Boite Food box	82	75 53 011	17,5 x 13 x 6	12	3,31
Couvercle		75 53 026	18,6 x 13,7	12	1,12
Boite Food box	122	75 53 012	21 x 15,5 x 6,5	12	4,00
Couvercle		75 53 027	21,4 x 15,8	12	1,32

Cassis



Lot de 6 bols avec couvercle coloré

Désignation	Code	Φ cm	SUR.	Prix HT
Lot 6 bols	50 39 040	23 - 20 - 17 - 14 - 13 (x2)	2	14,95



Lot de 5 bols avec couvercle gris

Désignation	Code	Φ cm	SUR.	Prix HT
Lot 5 bols	50 39 038	17,3 - 14,2 - 12,8 - 10,9 - 9,4	6	5,95



Lot de 4 saladiers avec couvercle coloré

Désignation	Code	Φ cm	SUR.	Prix HT
Lot 4 saladiers	16 11 889	23 - 20 - 17 - 14	2	14,84

VERRE BOROSILICATE
Sécurité alimentaire

Compatible congélateur, micro-ondes, lave vaisselle et four (sauf couvercle)

CONSERVATION
Par pression de l'air

OUVERTURE FACILE
Avec la languette

APPUYER POUR CONSERVER



Boîte ronde Lilas

Désignation	Code	Ccl	Ø x Ht cm	SUR.	Prix HT
Boîte ronde Lilas	50 39 080	25	9,7 x 5,4	6	4,70
Lilas	50 39 082	47	12,3 x 6,3	6	5,50



Boîte ronde Vert d'eau

Désignation	Code	Ccl	Ø x Ht cm	SUR.	Prix HT
Boîte ronde Vert d'eau	50 39 081	25	9,7 x 5,4	6	4,70
Vert d'eau	50 39 083	47	12,3 x 6,3	6	5,50



Boîte rectangle Lilas

Désignation	Code	Ccl	L x l x Ht cm	SUR.	Prix HT
Boîte rectangle Lilas	50 39 084	82	19,5 x 13,9 x 4,5	6	7,90
Lilas	50 39 086	150	21,9 x 17 x 6	6	9,90
	50 39 088	260	24,6 x 20 x 7,6	6	12,50



Boîte rectangle Vert d'eau

Désignation	Code	Ccl	L x l x Ht cm	SUR.	Prix HT
Boîte rectangle Vert d'eau	50 39 085	82	19,5 x 13,9 x 4,5	6	7,90
Vert d'eau	50 39 087	150	21,9 x 17 x 6	6	9,90
	50 39 089	260	24,6 x 20 x 7,6	6	12,50

Clémentine



Boîte carrée + couvercle

Désignation	Code	Ccl	L x l x Ht cm	SUR.	Prix HT
Boîte carrée	50 40 485	31	11,7 x 11,7 x 5,7	6	2,95
	50 40 486	50	15,5 x 15,5 x 6,8	6	3,55
	50 40 487	80	17,8 x 17,8 x 7,5	6	4,55



Boîte rectangulaire + couvercle

Désignation	Code	Ccl	L x l x Ht cm	SUR.	Prix HT
Boîte rectangulaire	50 40 488	37	15,3 x 11,2 x 5,7	6	2,95
	50 40 489	63	18 x 13,5 x 6,1	6	4,25
	50 40 490	104	20,5 x 15,5 x 7	6	4,95
	50 40 494	150	23 x 17,5 x 7,6	6	7,95
	50 40 503	226	24,5 x 19,5 x 7,7	6	8,25



Boîte ronde + couvercle

Désignation	Code	Ccl	Φ x Ht cm	SUR.	Prix HT
Boîte ronde	50 40 491	37	13,5 x 6,2	6	2,95
	50 40 492	64	15,5 x 6,8	6	3,95
	50 40 493	93	17,8 x 7,5	6	4,55

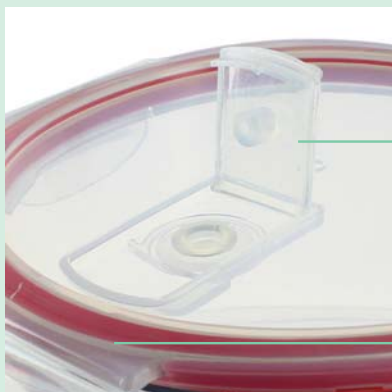

Compatible congélateur, micro-ondes, lave vaisselle et four (sauf couvercle)

**VALVE VAPEUR**

Pour réchauffer au micro-ondes

100% HERMÉTIQUE

Excellente conservation grâce au couvercle à clap muni d'un joint en silicone

**VERRE BOROSILICATE**

Résistant aux rayures ainsi qu'aux chocs. Il peut passer directement du congélateur au four. C'est un matériau sain sans BPA.

TERRINES

Collection by LE PARFAIT



Un acteur incontournable pour tous les professionnels de la restauration

Le Parfait



Bocal Bistrot

Le bocal "Bistrot", est disponible en deux tailles et dispose d'un système de fermeture hermétique à clips en acier inoxydable. Étanche, il permet de conserver et transporter les aliments en toute sécurité. Sans ses clips amovibles, le bocal est adapté au micro-ondes, ainsi qu'à la pasteurisation et stérilisation pour une conservation longue durée. Les clips sont fixés à l'armature, évitant tout risque de perte.



MONTURE INOX

3 Clips amovibles en acier inoxydable



Lot 6 bocaux 25,5 cl Lot 6 bocaux 42,5 cl Lot 6 bocaux 58 cl

Désignation	Code	Ccl	Ø x Ht cm	SUR.	Prix HT Lot de 6
Lot de 6 Bocaux bistrot	15 10 318	25,5	8,5 x 7,5	1	21,95
	15 10 319	42,5	9,5 x 9	1	28,65
	15 10 324	58	9,5 x 12,5	1	31,25



Stérilisateur

Le nouveau stérilisateur électrique et automatique Le Parfait® facilite la conservation des aliments avec une cuve en inox, des poignées thermo-isolantes, un couvercle en plastique noir, un robinet de vidange et un écran LCD avec minuterie automatique pour une stérilisation simple et efficace.



Stérilisateur 23 L

Stérilisateur 45 L

Code	Code	L	ø. x Ht. cm	SUR.	Prix HT
Stérilisateur	15 10 325	23	39 x 46	1	175,00
	15 10 326	45	38 x 61,5	1	210,00

Le Parfait "Color Vis"

Le meilleur bocal pour le vrac. Ces bocaux excellent dans la conservation de recettes qui ne nécessitent pas de traitement thermique (stérilisation ou pasteurisation). Des couvercles colorés pour dissocier vos préparations et vos plats à emporter.

Utilisation possible de capsules et couvercles Familia Wiss ø 100 sur la gamme À VIS.

Couvercles étanches grâce à leur nouveau joint Alvéolite qui prend la forme d'un disque plein blanc qui se maintient parfaitement dans le fond des couvercles.



Bocaux 1L

Bocaux 2L

Bocaux 3L

Désignation	L	Code	Ø x Ht cm	SUR.	Prix HT
Bocal Orange	1	15 10 315	10,8 x 17	6	3,15
	2	15 10 316	12,2 x 24,5	6	3,95
	3	15 10 317	13,8 x 27,5	3	6,75
Bocal Rouge	1	15 10 365	10,8 x 17	6	3,75
Bocal Bleu	2	15 10 361	12,2 x 24,5	6	5,15
Bocal Vert foncé	2	15 10 376	12,2 x 24,5	6	5,20
Bocal Vert clair	1	15 10 370	10,8 x 17	6	3,75
	3	15 10 372	13,8 x 27,5	3	6,75

Autres couleurs nous consulter

 **New products**
Nouveautés



Terrines «Le Parfait Familia Wiss»

Les Familia Wiss sont une alternative de choix pour la vente à emporter car une fois ouvertes elles passent au micro-ondes. Elles accueillent toutes les préparations (à l'exception des vinaigres et saumures qui favorisent la corrosion des capsules). La forme droite permet de démouler facilement.



Pack de 6 terrines

Désignation	Code	g	Ø x Ht cm	SUR.	Prix HT
6 terrines	15 10 145	200	8,75 x 6,25	1	13,95
couvercles + capsules	15 10 146	350	10,35 x 7,33	1	16,95
	15 10 147	500	10,35 x 9,38	1	17,95
	15 10 148	750	10,35 x 14,28	1	19,85
	15 10 149	1000	10,35 x 14,28	1	21,35
	15 10 150	1000	11,6 x 14,28	1	26,35
	15 10 151	1500	11,6 x 21,25	1	28,95



Bocaux vendus au pack avec rondelles fournies

Code	Pack	Ccl	ø. x Ht. cm	SUR.	Prix HT
15 10 006	6 bocaux	50	10,8 x 10,85	1	18,55
15 10 007	6 bocaux	75	10,8 x 14,5	1	20,20
15 10 008	6 bocaux	100	10,8 x 17,5	1	19,15
15 10 009	6 bocaux	150	10,8 x 25,5	1	25,65
15 10 010	6 bocaux	200	12 x 25	1	29,85
15 10 011	3 bocaux	300	13,8 x 28,34	1	24,80

Terrines LPS «Le Parfait Super»



Les terrines Le Parfait Super offrent le meilleur contenant pour pâtés, rillettes et autres préparations maison. Le modèle préféré des professionnels de la restauration, grâce à sa forme conique, parfaite pour démouler facilement toutes les recettes !



Pack de 6 terrines avec joint

Désignation	Code	g	Ø x Ht cm	SUR.	Prix HT
6 terrines	15 10 024	125	8,33 x 7,34	1	15,95
avec joint	15 10 025	200	8,33 x 8,65	1	16,85
	15 10 026	350	8,7 x 9,9	1	18,50
	15 10 027	500	9,2 x 10,7	1	23,95
	15 10 028	750	10 x 13,7	1	25,65
	15 10 029	1000	10 x 17,15	1	28,15



Bocaux LPS «Le Parfait Super»

Les bocaux Le Parfait Super, de part leur forme arrondie, leur rondelle et leur monture métallique à toute épreuve sont idéaux pour conserver fruits et légumes que ce soit au naturel, au sirop ou en soupes. Multi-usages, ils se prêtent aussi à la fermentation. Disponibles en grands formats, ils font d'excellents bocaux pour vos réserves.



Bouteilles Le Parfait

Le Parfait propose une famille complète de bouteilles en verre pour conserver les boissons, avec deux systèmes de fermeture. D'un côté le swing-top, allié conservation et service des eaux et jus. De l'autre, la bouteille fraîcheur, idéale pour la vente à emporter.



A. "Fraîcheur"
avec couvercle Twist off



B. "Swing top"
fermeture mécanique jumper

Désignation	Code	Ccl	ø. x Ht. cm	SUR.	Prix HT
A. Twist off	15 10 235	50	6,7 x 19	6	1,55
	15 10 236	100	8,4 x 25,2	6	1,80
B. Swing top	15 10 230	50	6,5 x 28	3	2,75
	15 10 231	100	8,5 x 34	3	3,20



Confituriers «Le Parfait»

Des bocaux spécialement conçus pour conserver les confitures.



C. Pot avec couvercle plastique (x6)



D. Pot avec couvercle métal (x6)



E. Pot avec couvercle métal (x8)

Code	Pack	Ccl	ø. x Ht. cm	SUR.	Prix HT
C. 12 10 193	6 pots	32,4	8,5 x 9,5	1	8,45
D. 12 10 189	6 pots	32,4	8,5 x 9	1	6,85
D. 12 10 190	6 pots	38,5	8,5 x 11	1	8,45
Offre avec gratuits 6+2					
E. 15 10 258	6 + 2 pots	32,4	8,5 x 9	1	8,15
E. 15 10 259	6 + 2 pots	38,5	8,5 x 11	1	6,45

Accessoires



F. Couvercle



G. Sachet de 6 couvercles



H. Lot de 10 capsules



I. Lot de 2 marqueurs

Désignation	Code	Ø cm	SUR.	Prix HT
F. Lot 6 couvercles	12 10 191	8,2	40	3,85
F. Lot 18 couvercles	12 10 185	8,2	15	11,55
G. Sachet 6 couvercles	15 10 240	8,2	20	4,70
	15 10 241	10	15	6,65
	15 10 242	11	15	7,35
H. Lot 10 capsules	15 10 070	8,2	24	6,95
	15 10 071	10	12	8,57
	15 10 072	11	12	10,65
I. Lot 2 marqueurs	15 10 248	feutres blancs	18	4,15

Accessoires «Le Parfait»

Des accessoires parfaitement adaptés aux produits Le Parfait. Compagnons indispensables des bocaux, terrines et confituriers Le Parfait, les rondelles, capsules et couvercles permettent de réaliser et conserver vos préparations sereinement.



J. Sachet de 10 rondelles universelles
convient aux terrines 500, 750, 1000 et bocal 3 L



L. Sachet de 10 rondelles universelles
convient aux terrines 125 cl et 250 cl



N. Sachet de 10 de rondelles 2 oreilles
Convient aux terrines 350 g et les bocaux 0,5 / 0,75 / 1 / 1,5 et 2 L



P. Tire rondelle



Q. Sachet de 27 étiquettes

Code	Pack	ø cm	SUR.	Prix HT
J. 15 10 062	10 rondelles	10	20	2,95
K. 15 10 061	10 rondelles	8,5	20	4,50
L. 15 10 060	10 rondelles	7	20	2,40
M. 15 10 096	30 rondelles	8,5	20	7,70

Code	Pack	ø cm	SUR.	Prix HT
N. 15 10 064	10 rondelles 2 oreilles	8,5	20	2,95
O. 15 10 052	10 rondelles 2 oreilles	7	50	2,85
P. 15 10 250	Tire rondelle		50	5,10
Q. 12 10 112	27 étiquettes adhésives		50	3,25

Colorama - Friteuse à air chaud



11L

Séparateur amovible
11L ou 2 cuves de 5,5L



5L

5L



Friteuse à air chaud double zone beige

Désignation	Code	Litres	L x l x Ht cm	SUR.	Prix HT
Friteuse double zone	60 25 025	11	40 x 39 x 30	1	142,50

Accessoires - Friteuse à air chaud



Moule silicone rectangle



Moule silicone carré



Moules papier (x50)



Panier cuisson



Moule cuisson

Désignation	Code	L x l x Ht cm	SUR.	Prix HT
Moule silicone rectangle	60 20 012	23 x 15 x 4,5	12	4,70
Moule silicone carré	60 20 013	20 x 20 x 3,8	12	4,70
Moules papier (x50)	50 40 103	20 x 20 x ?	10	2,70

Désignation	Code	Ø x Ht cm	SUR.	Prix HT
Panier cuisson	60 20 672	20 x 7	6	3,60
Moule cuisson	60 20 671	20 x 2,5	2,5	1,95



New products
Nouveautés

Colorama - Friteuse à air chaud

8 PROGRAMMES DE CUISSON

230V
1500W



Montée en température rapide
Short heating time



Minuterie d'1h
One-hour timer



80°C
200°C
Température réglable jusqu'à 200°C
Temperature adjustable up to 200°C

ÉCRAN LED TACTILE INTUITIF



Grille antiadhésive
Non-stick grill
Ø 22,5 cm

Poignée en bakélite effet bois
Wood effect bakelite handle

SOFT TOUCH

Pieds antidérapants
Non-slip feet

Cuve amovible
Borosilicate glass lid
22,5 x 10,3 cm



Désignation	Litres	Code	Ø x Ht cm	SUR.	Prix HT
● Safran	4,5	60 25 003	25 x 31	1	74,95
● Crème	4,5	60 25 004	25 x 31	1	74,95
● Céladon	4,5	60 25 001	25 x 31	1	74,95
● Rose	4,5	60 25 007	25 x 31	1	74,95
● Magenta	4,5	60 25 002	25 x 31	1	74,95
● Olive	4,5	60 25 006	25 x 31	1	74,95



Crème

Rose

Céladon

Safran

Magenta

Olive



Machine sous vide

Puissance réglable grâce à la fonction d'impulsion : réduit la dépression à l'intérieur du sachet pour éviter d'écraser les aliments. Fournie avec 10 sacs inclus 20 x 30 cm.



Vacu power 100 4L/min

Code	Watt	L x l x Ht cm	SUR.	Prix HT
02 12 002	100	37,8 x 6,6 x 10,3	3	79,20 EC : 0,11



Vacu power 300 9L/min

Code	Watt	L x l x Ht cm	SUR.	Prix HT
02 12 003	300	36 x 8,7 x 16,5	2	111,95 EC : 0,21



Set 3 boîtes sous vide

Code	L x l cm ou ml	SUR.	Prix HT
02 12 005	500/800/1400	4	71,93

Le set comprend 3 boîtes fraîcheurs sous vide de 500 mL, 800 mL et 1400 mL sans BPA. Muni d'un tuyau adaptateur compatible avec toutes les machines Leifheit. Convient au lave vaisselle, et congélateur jusqu'à -20°C.



Vacu power 500 12L/min

Code	Watt	L x l x Ht cm	SUR.	Prix HT
02 12 001	500	39,5 x 9,5 x 21,5	2	153,19 EC : 0,21



Percolateur à café

Code	Φ x Ht cm	SUR.	Prix HT
46 10 868	32,2 x 47,2	3	213,50

Percolateur permettant de préparer jusqu'à 12 tasses de café. Facile à utiliser, il maintient le café chaud pendant plusieurs heures et assure une bonne qualité de boisson grâce à son système de filtration.



Blender professionnel *

Code	L x l x Ht cm	SUR.	Prix HT
46 10 835	23 x 20,5 x 5,1	1	543,94 EC : 0,71

Mixeur de haute qualité, 950W. Poids 5 kg. Capacité 2L. Vitesses variables 13 300-26 600 et 38 000 tours/min. Fonction pulse glace pilée, 3 programmations 35, 60 et 90 sec. Bloc couteaux 6 lames multidirectionnelles. Possibilités d'ajouter des aliments en cours de préparation grâce au couvercle.



Corps de chauffe électrique 92°C pour chafing dish

Code	Watt	L x l cm	SUR.	Prix HT
46 10 830	700	20 x 25	1	235,00 Avec régulateur.



Chafing Dish

Code	Ccl	L x l x Ht cm	SUR.	Prix HT
46 10 828	850	56 x 35 x 28	1	116,85

Chafing Dish basic inox GN 1/1 avec couvercle. Supports de brûleurs fournis pour gel de chauffe 225gr Ethanol. Autonomie 3h.





Cafetière crème 12 tasses

Code	Litres	L x l x Ht cm	SUR.	Prix HT
60 25 050	1,5	18 x 27 x 30	6	21,90 EC : 0,46



Bouilloire crème 1,7L

Code	Litres	L x l x Ht cm	SUR.	Prix HT
60 25 051	1,7	15,7 x 18,5 x 24,6	6	20,70 EC : 0,34



Grille-Pain crème 2 fentes

Code	L x l x Ht cm	SUR.	Prix HT
60 25 052	19 x 29 x 21	6	23,95 EC : 0,18



Cafetière Includeo Noir 1,25 L

Code	Ccl	Ø x Ht cm	SUR.	Prix HT
42 12 103	125	23,1 x 22,6 x 34	2	62,38 EC : 0,20

Design inclusif pensé pour une utilisation facile par tous. Porte-filtre amovible avec double poignée pour une prise en main optimale. Poignée ergonomique et base stable pour plus de sécurité. Large réservoir d'eau avec indicateurs faciles à lire. Bouton marche/arrêt simple d'utilisation.



Grille pain Includeo

Code	L x l x Ht cm	SUR.	Prix HT
42 12 202	27,2 x 17,1 x 18,8	4	62,38 EC : 0,25

Grille-pain ergonomique avec 2 fentes extra-larges adaptées à tous types de pains. Commandes à haute visibilité et lisibilité pour une utilisation facile. Pince de préhension avec une face en silicone et levier de surélévation pour retirer les tranches en toute sécurité. 7 niveaux de dorage réglables.



Bouilloire 1,7L

Code	Couleur	L x l x Ht cm	SUR.	Prix HT
60 25 055	Crème	28,6 x 31,2 x 18,9	8	27,50
60 25 056	Céladon	28,6 x 31,2 x 18,9	8	27,50
60 25 057	Brique	28,6 x 31,2 x 18,9	8	27,50
60 25 058	Bleu	28,6 x 31,2 x 18,9	8	27,50
60 25 059	Rose	28,6 x 31,2 x 18,9	8	27,50

Puissance 1850-2200W. Ultra compacte et très pratique. Boîtier thermorésistant, sans fil avec rotation 360°, bouton d'alimentation LED et ouverture du couvercle intégrée à la poignée.

Les couverts

Amefa

OGO
LIVING



Havane

Design léger et moderne forme en arc tendu



Filla

Classique et élégant, le filet souligne le contour et l'harmonie

OGO
LIVING

tehrin



Arès

Design graphique et intemporel avec le jeu de lignes asymétriques



Tamtam

Effet modelé avec une finition poli



04

COUVERTS



Couverts séries	222 à 233
Couteaux à steak	234 à 235
Cuillères	236
Fruits de mer	237

Valmy 1.5mm

Finition standard, inox 18.0

Amefa



Désignation	Code	Long cm	Sur.	Prix HT
A . Fourchette	48 35 980	20	12	0,36
B . Cuillère table	48 35 981	20,3	12	0,36
C . Cuillère café	48 35 982	13,3	12	0,20
D . Couteau table	48 35 983	21,8	12	0,66
E . Couteau à steak	48 35 988	22,4	12	1,52
Fourchette dessert	48 35 984	17,2	12	0,47
Cuillère dessert	48 35 985	17,2	12	0,47
Couteau dessert	47 10 248	20,3	12	0,77
Fourchette huître	48 35 986	13	12	0,32
Fourchette escargot	48 35 987	13,5	12	0,46
Fourchette tapas	48 35 989	13,5	12	0,31
Cuillère moka	48 35 990	11	12	0,12

Amsterdam 2.2mm

Finition satinée, inox 18.0

Amefa

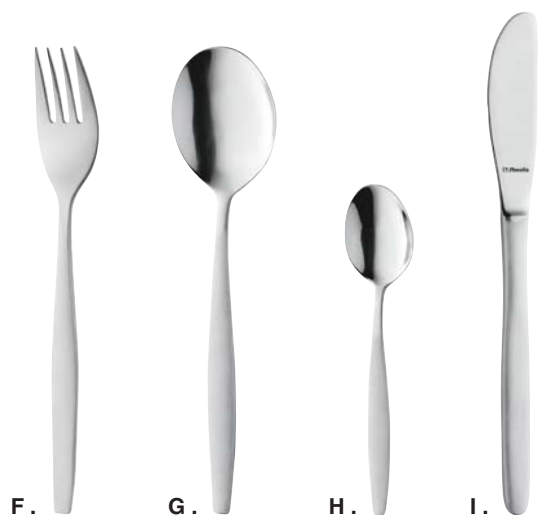

Resto 2mm

Finition standard, inox 18.0

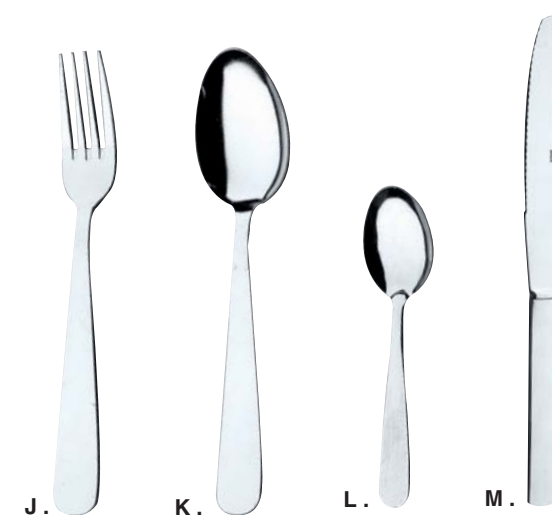

Désignation	Code	Long cm	Sur.	Prix HT
F . Fourchette	47 35 541	19	12	1,36
G . Cuillère table	47 35 542	17,8	12	1,36
H . Cuillère café	47 35 543	13,8	12	1,19
I . Couteau	47 35 544	20	12	2,86

Désignation	Code	Long cm	Sur.	Prix HT
J . Fourchette	47 35 110	20	12	0,58
K . Cuillère table	47 35 111	20,3	12	0,58
L . Cuillère café	47 35 112	13,2	12	0,25
M . Cout. monobloc	47 35 113	22	12	0,98
Couteau cranté	47 35 018	22,6	12	1,34

Ocean 1.8mm

Finition standard brillant, inox 18.0

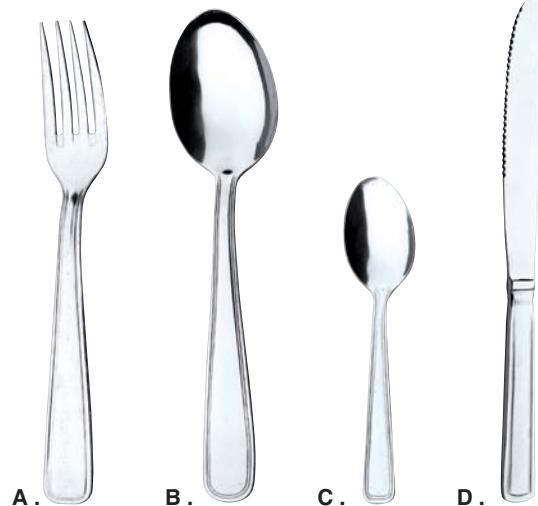

Désignation	Code	Long cm	Sur.	Prix HT
A . Fourchette table	47 10 001	20,5	12	0,86
B . Cuillère table	47 10 002	20	12	0,86
C . Cuillère café	47 10 003	13,5	12	0,52
D . Couteau table	47 10 004	22	12	1,85

Olga 1.8mm

Finition brillant, inox 18.0



Désignation	Code	Long cm	Sur.	Prix HT
E . Fourchette table	47 10 092	19,5	12	0,56
F . Cuillère table	47 10 093	19,3	12	0,56
G . Cuillère café	47 10 091	12,8	12	0,32
H . Cout. Monobloc	47 10 088	21	12	1,36
Cuil.soda Mazagran	47 10 090	17,7	12	0,62
Cuillère moka	47 10 089	11,3	12	0,30
Couteaux steak	47 10 094	21,5	12	2,25

Contour 2mm

Finition brillant, inox 18.0

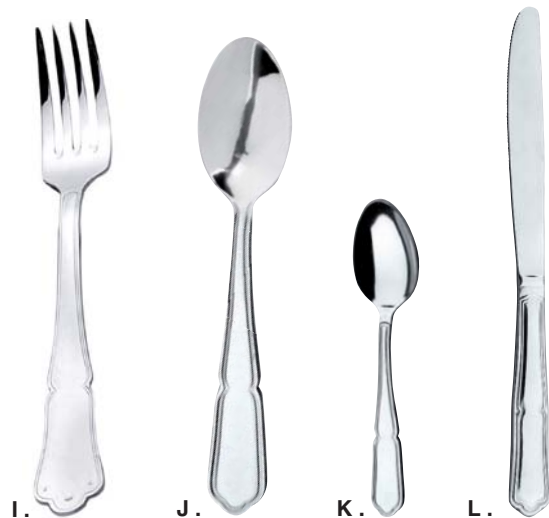

Désignation	Code	Long cm	Sur.	Prix HT
I . Fourchette	47 10 220	21	12	0,89
J . Cuillère table	47 10 221	20,7	12	0,89
K . Cuillère café	47 10 222	14,2	12	0,47
L . Couteau	47 10 223	22,5	12	2,97
Fourchette dessert	47 10 225	18	12	0,89
Cuillère dessert	47 10 226	18	12	0,89

tehrin

Drakkar 2mm

Finition miroir, inox 18.0

tehrin

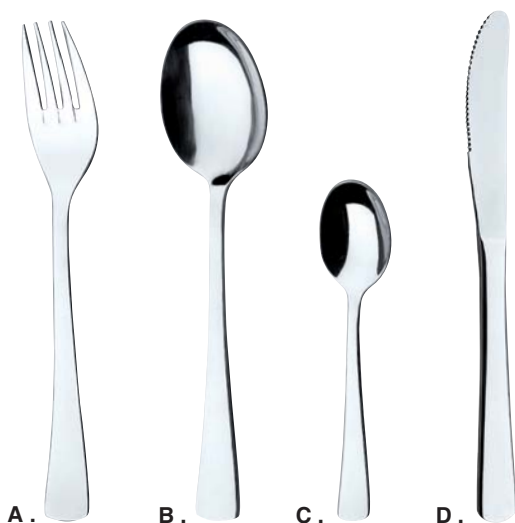

Désignation	Code	Long cm	Sur.	Prix HT
A . Fourchette	47 10 970	20,1	12	1,21
B . Cuillère table	47 10 971	19,7	12	1,21
C . Cuillère café	47 10 972	13,6	12	0,94
D . Cout. monobloc	47 10 973	20,8	12	2,10
Cuillère moka	47 10 980	11,7	12	0,97
Cuil.soda Mazagran	47 10 978	22,5	12	1,53
Cuil.coudée Mazag.	47 10 979	19,2	12	1,53

Slim 0.5mm

Finition standard, inox 18.0

**Manille 2mm**

Finition standard, inox 18.0

Amefa

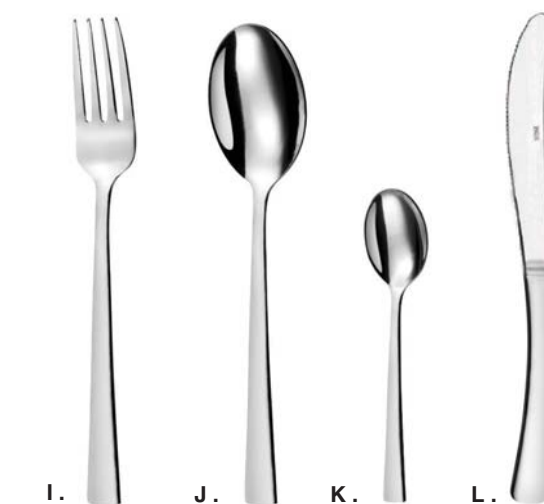

Désignation	Code	Long cm	Sur.	Prix HT
E . Fourchette table	47 40 153	16,5	20	2,45
F . Cuillère table	47 40 154	16,5	40	2,34
G . Cuillère café	47 40 155	12,5	40	1,95
H . Couteau table	47 40 152	16,5	20	2,94
Fourchette dessert	47 40 156	12	40	2,13

Lot de 12 pièces

Désignation	Code	Long cm	Sur.	Prix HT
I . Fourchette table	47 35 370	20,5	12	0,63
J . Cuillère table	47 35 371	20,5	12	0,63
K . Cuillère café	47 35 372	13,5	12	0,36
L . Couteau table	47 35 373	22	12	1,10

Tradition 2mm

Finition standard, inox 18.0

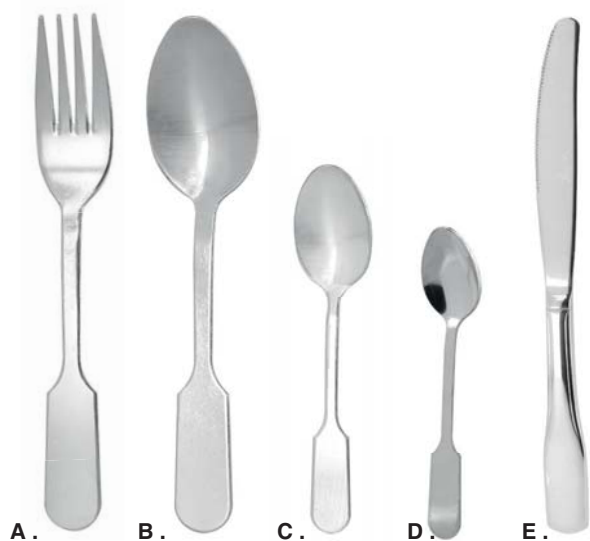

Désignation	Code	Long cm	Sur.	Prix HT
A. Fourchette	47 12 005	20	12	0,48
B. Cuillère table	47 12 006	20	12	0,48
C. Cuillère dessert	47 12 008	17,5	12	0,48
D. Cuillère café	47 12 007	14	12	0,23
E. Couteau table	47 12 009	23,5	12	1,83

Vieux Paris 2.5mm

Finition satinée, sans virgule, inox 18.0

**Lutécia 2mm**

Finition miroir, sans virgule, inox 18.0

lehrin

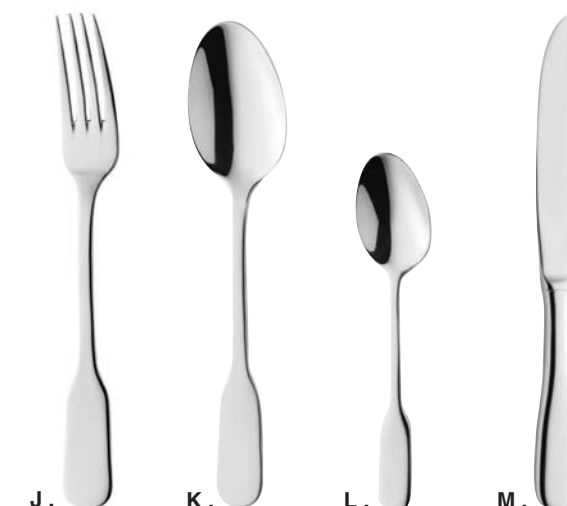
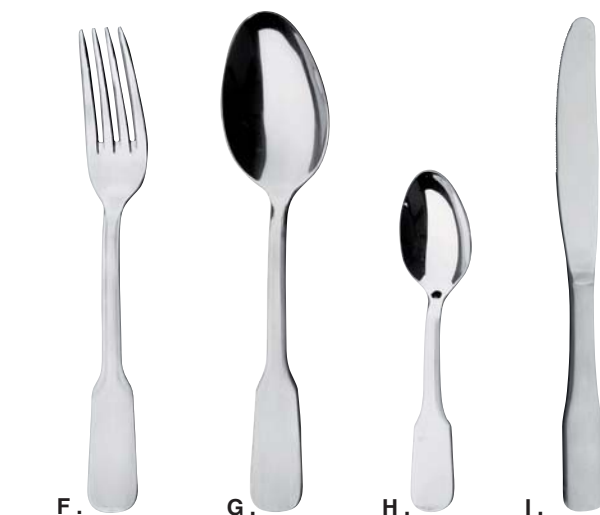

Désignation	Code	Long cm	Sur.	Prix HT
F. Fourchette	47 10 385	20,7	12	1,87
G. Cuillère table	47 10 386	21	12	1,87
H. Cuillère café	47 10 387	13,8	12	1,29
I. Couteau monobloc	47 10 388	23,3	12	3,22
Cout. dess. monobloc	47 10 389	20,5	12	3,22
Cuillère dessert	47 10 391	17,4	12	1,87

Désignation	Code	Long cm	Sur.	Prix HT
J. Fourchette	47 10 491	19,5	12	1,44
K. Cuillère table	47 10 492	19,5	12	1,44
L. Cuillère à café	47 10 493	14	12	1,04
M. Couteau tradition	47 12 009	23,5	12	1,83
Cuillère dessert	47 10 498	27	12	0,84

Adonis 2mm

Finition miroir, Inox 18.0.

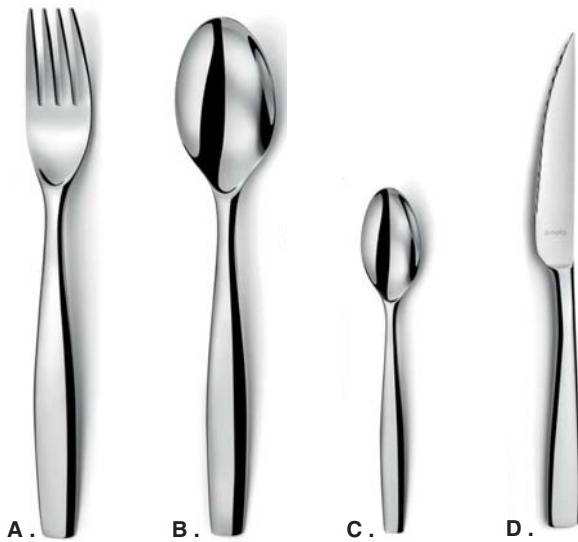

Désignation	Code	Long cm	Sur.	Prix HT
A . Fourchette	47 35 662	20	12	1,51
B . Cuillère table	47 35 663	20	12	1,51
C . Cuillère café	47 35 664	13,6	12	1,06
D . Couteau table	47 35 665	22	12	2,99
Couteau steak	47 35 666	22	12	2,99
Fourchette dessert	47 35 667	18	12	1,51
Cuillère dessert	47 35 668	18	12	1,51
Couteau dessert	47 35 669	19,8	12	2,97
Couteau poisson	47 35 670	20,3	12	1,51

Adonis icy 2mm

Finition givre, Inox 18.0.

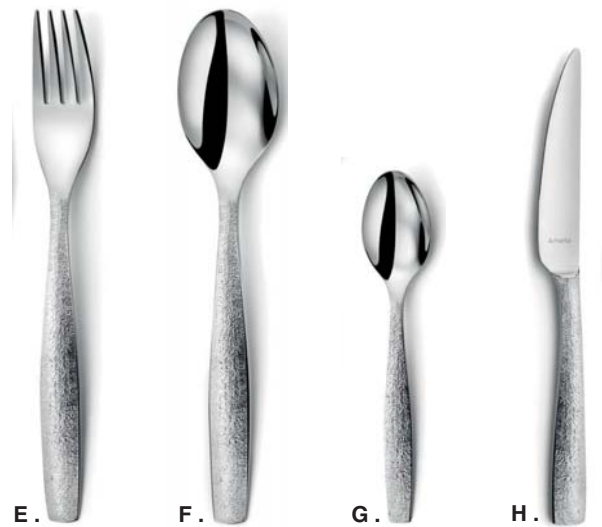

Désignation	Code	Long cm	Sur.	Prix HT
E . Fourchette	47 35 676	20	12	1,59
F . Cuillère table	47 35 677	20	12	1,59
G . Cuillère café	47 35 678	13,6	12	1,12
H . Couteau table	47 35 679	22	12	3,13
Fourchette dessert	47 35 680	18	12	1,51
Cuillère dessert	47 35 681	18	12	1,51
Couteau dessert	47 35 682	19,8	12	2,97

Canisse Bambou 3mm

Finition miroir, inox 18.0

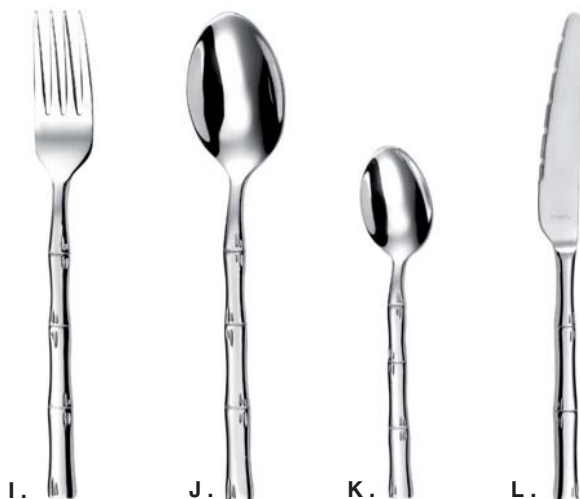

Désignation	Code	Long cm	Sur.	Prix HT
I . Fourchette	47 35 578	20	12	1,57
J . Cuillère table	47 35 579	19,7	12	1,57
K . Cuillère café	47 35 580	14,6	12	1,27
L . Couteau	47 35 581	23,3	12	2,69

INSTINCT 2mm

Finition brillant, Inox 18.0.

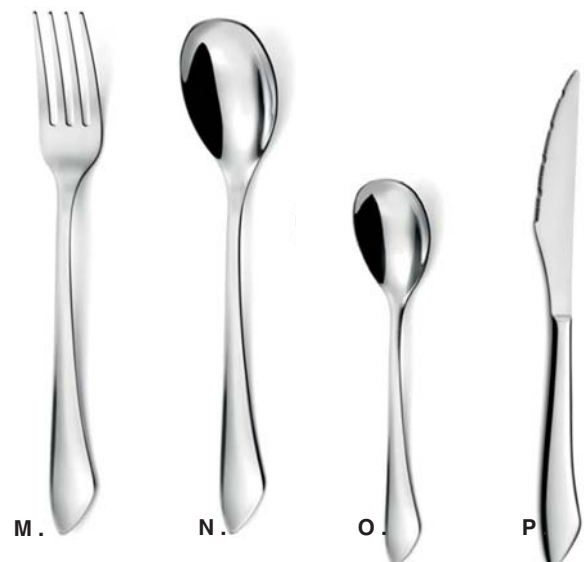

Désignation	Code	Long cm	Sur.	Prix HT
M . Fourchette	47 35 380	20,4	12	1,28
N . Cuillère table	47 35 381	20,2	12	1,28
O . Cuillère café	47 35 382	13,8	12	0,95
P . Couteau table	47 35 383	22,2	12	2,13



Ambition 2mm

Finition miroir, inox 18.0.

Louise 3mm

Finition miroir, inox 18.0

novastyl

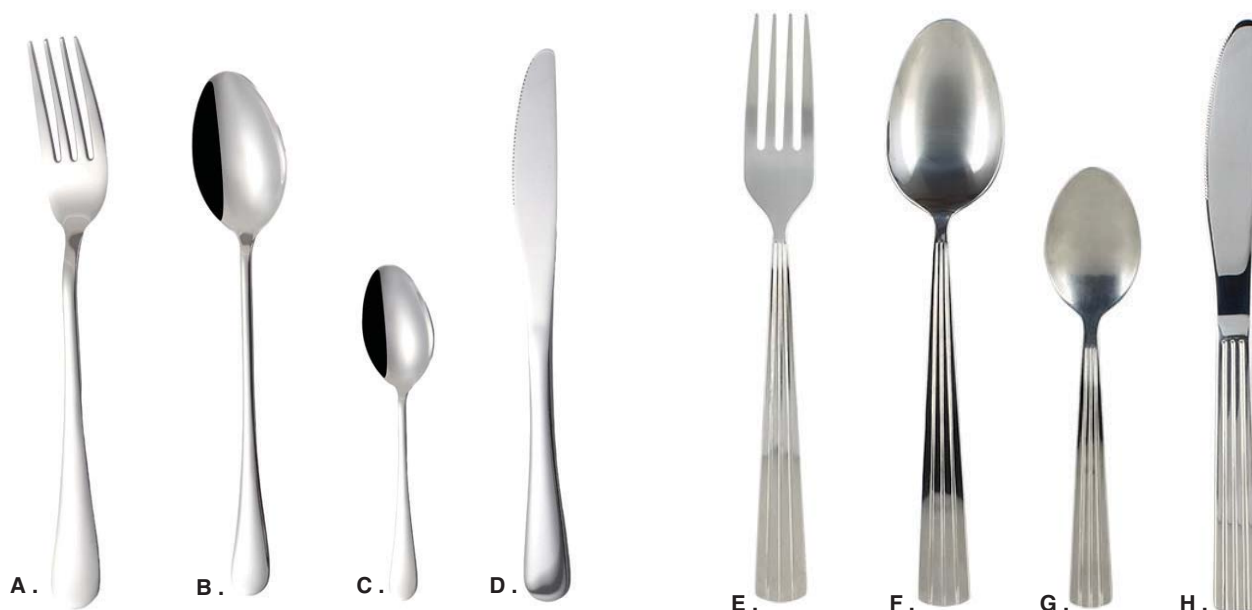

Désignation	Code	Long cm	Sur.	Prix HT
A . Lot de 4 Fourchette	47 25 331	20	6	Le set 2,73
B . Lot de 4 Cuillère table	47 25 332	20	6	2,73
C . Lot de 4 Cuillère café	47 25 333	14,5	6	1,85
D . Lot de 2 Couteaux	47 25 330	22	6	2,19

Désignation	Code	Long cm	Sur.	Prix HT
E . Fourchette de table	47 25 381	20,5	6	0,99
F . Cuillère table	47 25 382	19,6	6	0,99
G . Cuillère café	47 25 383	14	6	0,65
H . Couteau	47 25 384	22,5	6	0,99
Menagère 16 pièces	47 25 380		6	12,95

**Suva bois**

Désignation	Code	Sur.	Prix HT
Suva bois 24 pièces	47 25 297	3	24,95

**Lima Inox**

Désignation	Code	Sur.	Prix HT
Lima inox 24 pièces	47 25 275	3	17,95

**Lina Crème brique céladon**

Désignation	Code	Sur.	Prix HT
Lina Brique 24 pièces	47 25 349	3	22,50
Lina Céladon 24 pièces	47 25 344	3	22,50
Lina Crème 24 pièces	47 25 339	3	22,50

Caractère 4mm

Finition miroir, acier inoxydable 18.0



Désignation	Code	Long cm	Sur.	Prix HT
A . Fourchette table	47 35 040	20,8	12	2,13
B . Cuillère table	47 35 041	20,5	12	2,13
C . Cuillère café	47 35 042	14,5	12	1,42
D . Couteau steak	47 35 043	23,3	12	3,22
Fourchette dessert	47 35 045	18,2	12	2,03
Cuillère dessert	47 35 046	18,5	12	2,03
Couteau dessert	47 35 047	20,5	12	2,94

Carlton A forgé

Finition miroir, Inox 18.0.



Désignation	Code	Long cm	Sur.	Prix HT
E . Fourchette	47 35 530	19,5	12	2,30
F . Cuillère table	47 35 531	19,7	12	2,30
G . Cuillère café	47 35 532	14,2	12	1,58
H . Couteau table	47 35 533	21,2	12	2,86
Couteau steak	47 35 534	21,5	12	2,86
Fourchette dessert	47 35 535	18	12	2,18
Cuillère dessert	47 35 536	18	12	2,19
Couteau dessert	47 35 537	20	12	2,72

Athéna 3mm

Finition miroir, Inox 18.0.

OGO
LIVING

Désignation	Code	Long cm	Sur.	Prix HT
A. Fourchette table	47 12 039	21	12	1,80
B. Cuillère table	47 12 044	21	12	1,80
C. Cuillère café	47 12 046	14	12	1,05
D. Couteau table	47 12 036	23	12	2,75
Fourchette poisson	47 12 040	19	12	1,44
Couteau poisson	47 12 037	21	12	1,44
Fourchette dessert	47 12 043	19	12	1,30
Cuillère dessert	47 12 045	19	12	1,70
Couteau dessert	47 12 038	20,5	12	2,02
Cuillère moka	47 12 047	10,5	12	0,73
Couteau steak	47 12 035	23	12	2,30

Ariane 3mm

Finition miroir, Inox 18.0.

SINCE 1931
Amefa

Désignation	Code	Long cm	Sur.	Prix HT
E. Fourchette	47 10 860	20,5	12	1,70
F. Cuillère table	47 10 861	20,6	12	1,70
G. Cuillère café	47 10 862	13,7	12	0,82
H. Couteau table	47 10 863	23	12	2,96

Jet 2.5mm

Finition brillant, Inox 18.0.

Lou Laquière®

Désignation	Code	Long cm	Sur.	Prix HT
I. Fourchette	47 35 570	20,7	12	1,63
J. Cuillère table	47 35 571	20,7	12	1,63
K. Cuillère café	47 35 572	14	12	1,38
L. Couteau	47 35 573	22,4	12	3,32
Fourchette dessert	47 35 574	17,8	12	1,60
Cuillère dessert	47 35 575	18	12	1,61
Couteau dessert	47 35 576	19,5	12	3,13

Havane 3mm

Finition miroir, inox 18.0.

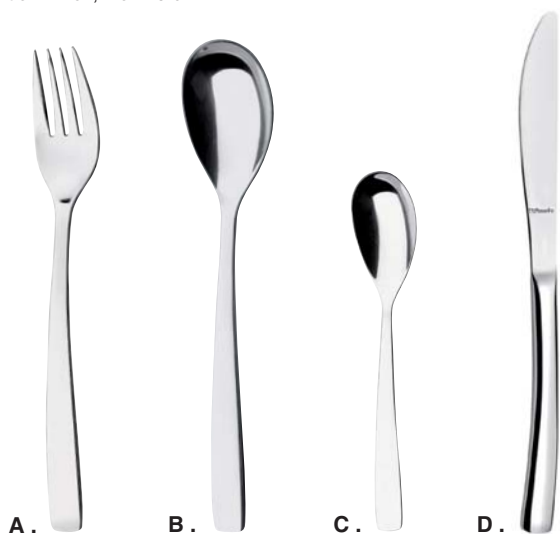

Désignation	Code	Long cm	Sur.	Prix HT
A . Fourchette	47 35 451	20,7	12	1,79
B . Cuillère table	47 35 452	20,5	12	1,79
C . Cuillère café	47 35 453	13,5	12	0,84
D . Couteau	47 35 454	23,5	12	2,67
Fourchette dessert	47 35 455	17,7	12	1,68
Cuillère dessert	47 35 456	17,7	12	1,68

Havane Jungle 3mm

Décor gravé 2 faces, acier inoxydable 18.0

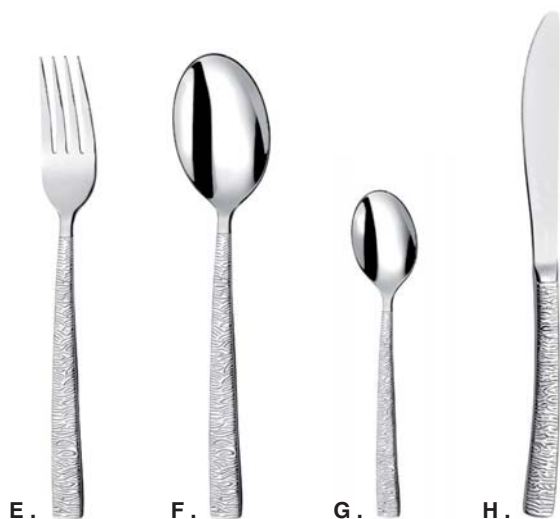

Désignation	Code	Long cm	Sur.	Prix HT
E . Fourchette	47 35 180	20,7	12	1,97
F . Cuillère table	47 35 181	20,5	12	1,97
G . Cuillère café	47 35 182	13,5	12	0,91
H . Cout.monobloc	47 35 183	23,5	12	2,89
Fourchette dessert	47 35 185	17,7	12	1,88
Cuillère dessert	47 35 186	17,6	12	1,88

Métropole 4mm

Finition miroir, Inox 18.10



Désignation	Code	Long cm	Sur.	Prix HT
I . Fourchette	47 38 125	21,1	12	4,46
J . Cuillère table	47 38 126	21	12	4,46
K . Cuillère café	47 38 127	14	12	3,07
L . Couteau	47 38 128	22,5	12	6,39
Fourchette dessert	47 38 131	19,4	12	4,18
Cuillère dessert	47 38 132	19,2	12	4,18
Couteau dessert	47 38 133	20,5	12	6,02
Cuillère moka	47 38 134	11,5	12	2,90

Arès Vintage 3mm

Finition patiné, inox 18.0

OGO
LIVING



A. B. C. D.



Désignation	Code	Long cm	Sur.	Prix HT
A . Fourchette table	47 12 086	20,5	12	1,55
B . Cuillère table	47 12 087	20,5	12	1,55
C . Cuillère café	47 12 088	14	12	0,90
D . Couteau steak	47 12 085	22,5	12	2,90

Arès 3mm

Finition miroir, inox 18.0.

OGO
LIVING

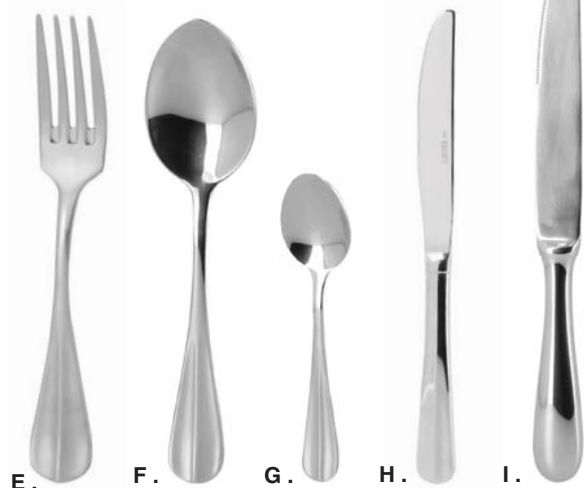

E. F. G. H. I.

Désignation	Code	Long cm	Sur.	Prix HT
E . Fourch. table	47 12 075	20,5	12	1,55
F . Cuillère table	47 12 078	20,5	12	1,55
G . Cuillère café	47 12 080	13,8	12	0,90
H . Couteau table	47 12 072	23,5	12	2,80
I . Couteau orfèvre	47 12 071	25	12	6,27
Couteau steak	47 12 070	20,5	12	2,95
Fourchette dessert	47 12 077	18,5	12	1,45
Cuillère dessert	47 12 079	18,5	12	1,45
Couteau dessert	47 12 074	20,5	12	2,85
Fourchette poisson	47 12 076	18,5	12	1,45
Couteau poisson	47 12 073	20,5	12	1,65
Cuillère moka	47 12 081	10,5	12	0,85
Cuillère soda	47 12 082	20	12	2,15

Baguette 2.5mm

Finition miroir, inox 18.0.

Since 1921
Amefa

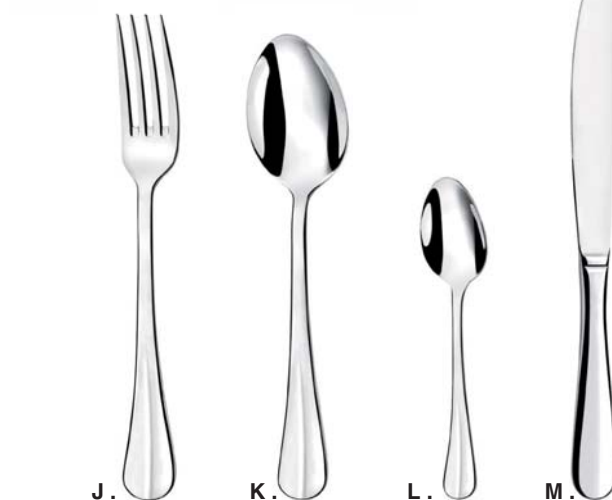

J. K. L. M.

Désignation	Code	Long cm	Sur.	Prix HT
J . Fourchette	47 35 050	21	12	1,98
K . Cuillère table	47 35 051	21	12	1,98
L . Cuillère café	47 35 052	14	12	1,16
M . Couteau table	47 35 053	23,5	12	2,84
Cuillère moka	47 35 060	12,5	12	1,10
Couteau steak	47 12 070	22,5	12	2,95

Tam Tam 3mm

Finition martelée, acier 18.0.

tehrin

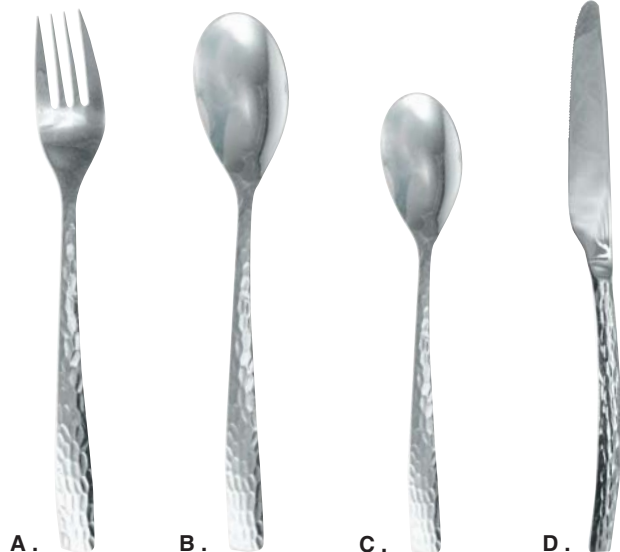

Désignation	Code	Long cm	Sur.	Prix HT
A . Fourchette	47 11 810	21	12	2,10
B . Cuillère table	47 11 811	21	12	2,10
C . Cuillère café	47 11 812	14	12	1,31
D . Couteau	47 11 813	23	12	2,75
Couteau steak	47 11 814	22	12	3,42
Fourchette dessert	47 11 815	18	12	2,10
Cuillère dessert	47 11 816	18	12	2,10
Couteau dessert	47 11 817	20,5	12	2,75
Cuillère moka	47 11 821	12	12	1,16

Esmeralda 2.5mm

Finition poli-glace inox 18.0, le manche courbé, stylé et moderne.

Cabana 3mm

Finition miroir, Inox 18.0.

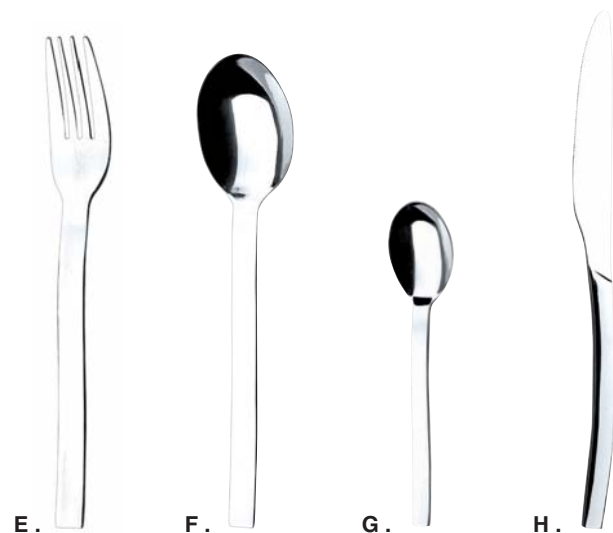

Désignation	Code	Long cm	Sur.	Prix HT
E . Fourchette	47 10 820	20,6	12	1,83
F . Cuillère table	47 10 821	20,4	12	1,83
G . Cuillère café	47 10 822	14,5	12	1,29
H . Couteau	47 10 823	23	12	2,62
Couteau steak monobloc	47 10 824	22	12	3,42
Fourchette dessert	47 10 825	19	12	1,83
Cuillère dessert	47 10 826	19	12	1,83
Couteau dessert monobloc	47 10 827	20,5	12	2,62

Désignation	Code	Long cm	Sur.	Prix HT
I . Fourchette	47 10 932	20,4	12	2,00
J . Cuillère table	47 10 933	20,5	12	2,00
K . Cuillère café	47 10 934	14,2	12	1,29
L . Couteau	47 10 935	23	12	2,62
M . Couteau steak	47 10 937	23	12	3,42
Couteau dessert	47 10 936	20,5	12	2,62
Fourchette dessert	47 10 938	18	12	2,00
Cuillère dessert	47 10 939	18,5	12	2,00



Nature forgé 6mm

Finition miroir, acier 18.0.



Désignation	Code	Long cm	Sur.	Prix HT
A. Fourchette table	47 12 063	19,4	12	1,90
B. Cuillère table	47 12 065	19,4	12	1,90
C. Cuillère café	47 12 066	13,4	12	1,35
D. Couteau table	47 12 061	21,3	12	2,15
Fourchette dessert	47 12 064	18	12	1,70
Cuillère dessert	47 12 067	18	12	1,75
Couteau steak	47 12 060	22	12	2,25
Couteau dessert	47 12 062	19,5	12	1,95

Filla 3mm

Finition miroir, Inox 18.0.

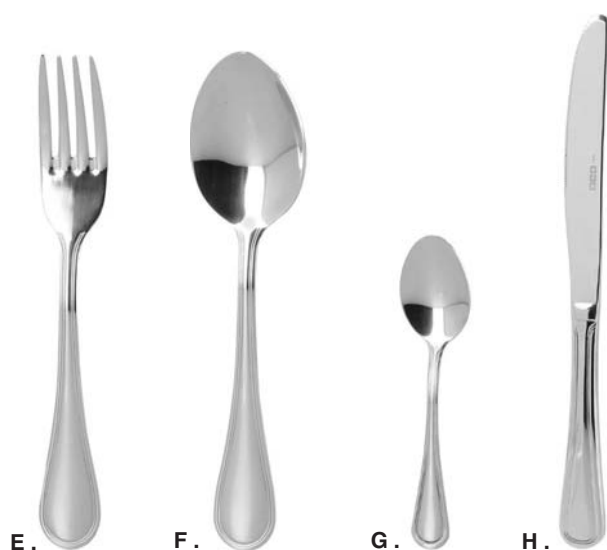

Désignation	Code	Long cm	Sur.	Prix HT
E . Fourchette table	47 12 019	21	12	2,15
F . Cuillère table	47 12 023	21	12	1,73
G . Cuillère café	47 12 024	14	12	1,04
H . Couteau table	47 12 016	24	12	2,27
Couteau steak	47 12 015	22,3	12	2,95
Fourchette dessert	47 12 020	18,5	12	1,60
Cuillère dessert	47 12 025	18,5	12	1,25
Couteau dessert	47 12 018	20,3	12	2,15
Fourchette poisson	47 12 027	17,5	12	1,59
Couteau poisson	47 12 017	21	12	1,60
Cuillère moka	47 12 026	11	12	0,88

Vintage

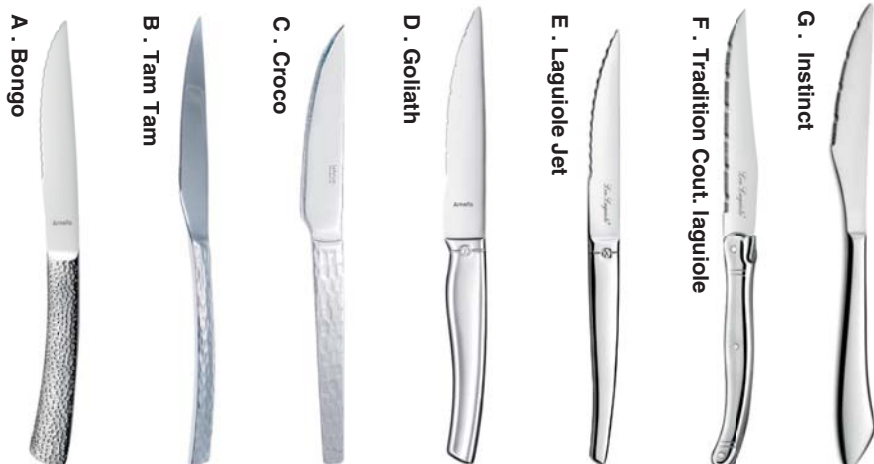

Code	Long cm	Sur.	Prix HT
A . 47 35 614	23	6	4,17
B . 47 11 814	23	12	3,42
C . 47 10 712	22	12	1,38
D . 47 35 832	23	6	3,96
E . 47 35 573	22,4	12	3,32
F . 47 40 098	23	6	2,48
G . 47 35 383	22,2	12	2,13

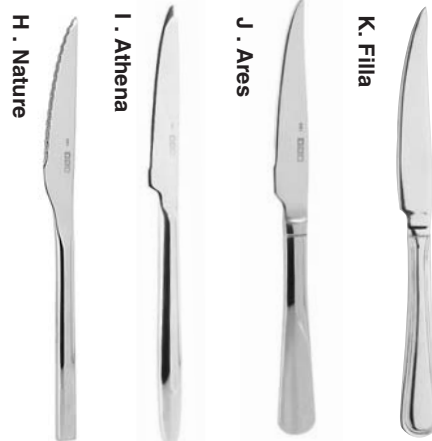

Code	Long cm	Sur.	Prix HT
H . 47 12 060	21,5	12	2,25
I . 47 12 035	22,8	12	2,30
J . 47 12 070	22,5	12	2,95
K . 47 12 015	22	12	2,95

Monobloc Inox

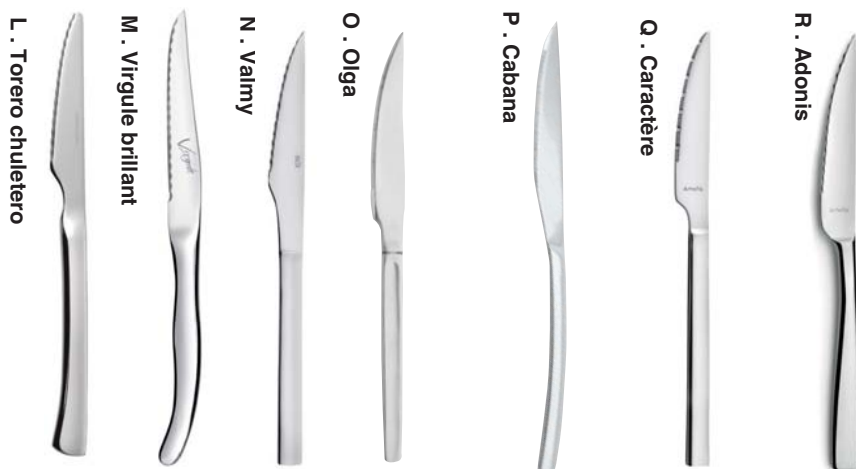

Code	Long cm	Sur.	Prix HT
L . 47 10 264	22,7	12	2,56
M . 47 35 013	23	12	4,27
N . 48 35 988	22,4	12	1,51
O . 47 10 094	20,9	12	2,25

Code	Long cm	Sur.	Prix HT
P . 47 10 937	23	12	3,42
Q . 47 35 043	23	12	3,22
R . 47 35 666	22	12	2,99

Bout rond



Code	Long/lame cm	Sur.	Prix HT
S . 47 35 018	22,6	12	1,34
T . 47 35 753	21,5	12	0,78
U . 47 10 139	20,2	12	0,52



Affutables

A. Emperor ABS pleine soie 2mm



B. Louchebein



C. Mont Blanc



D. ACHILLE PAKKA



E. SENSE



F. PIZZA NOIR LAME MARTELÉE



G. VOLCANO



Code	Long cm	Sur.	Prix HT
A . 48 35 028	23,5	12	10,37
B . 47 10 410	23,7/13	12	9,46
C . 48 35 718	23	6	11,00
D . 47 35 828	22,7	6	8,69
E . 47 35 822	22,7	12	5,78
F . 47 35 836	22,7	12	3,14
G . 47 35 823	22,7	12	9,52

PP

H. Artisan



I. Steak manche noir (lot de 6)



J. Pizza



K. 2 Rivets campagnard



L. Trappeur



M. Pizza



N. Jumbo



O. Steak PP



Code	Long/lame cm	Sur.	Prix HT
H . 47 10 130	22	12	1,68
I . 47 25 008	16 (lot de 6)	12	4,95
J . 47 35 751	20,5	12	0,99
K . 47 35 007	22,5	12	0,86

Code	Long/lame cm	Sur.	Prix HT
L . 47 35 174	24,5/12,4	54	1,41
M . 47 10 287	21,2	12	3,22
N . 47 35 019	25/12	12	4,10
O . 47 10 260	21	12	0,55



Imitation

P. Steak Bois



Q. Office manche bois



R. Campagnard 2 rivets



Code	Long cm	Sur.	Prix HT
P . 47 10 242	20,5/10,5	12	1,06
Q . 50 25 982	19/9	36	1,44
R . 47 35 009	22,5/10	12	1,55

S. Steak pizza bois



T. Bambou



U. Steak manche bois (lot de 6)



Code	Long cm	Sur.	Prix HT
S . 47 35 026	21	12	3,30
T . 47 10 631	23,3	12	3,93
U . 47 25 009	15 (lot de 6)	12	5,50



Soda et glace



A . Sangria



B . Mazagran



C . Soda Drakkar



D . Drakkar coudée



E . Soda Olga

Code	Long cm	Sur.	Prix HT
A . 47 10 126	27	12	1,58
B . 47 10 127	20,5	12	0,92
C . 47 10 978	20	12	1,53
D . 47 10 979	20	12	1,53
E . 47 10 090	17,7	12	0,62

Cuillères et Moka



J . Moka primo (x6)



K . Moka bar (x120)



L . Cuillères moka Valmy



M . Vésuve (x12)



N . Olga café



O . Tradition café



P . Tradition dessert

Code	Long cm	Sur.	Prix HT
J . 47 40 095	11,4	6	0,94
K . 47 10 039	11	1	23,12
L . 48 35 990	11	12	0,15
M . 47 35 023	11	1	1,92
N . 47 10 089	11	12	0,30
O . 47 12 007	14,2	12	0,23
P . 47 12 008	17,5	12	0,48



F . Cuillère cocktail Éco



G . Cuillère à glaçons Drakkar



H . Cuillère à glace aluminium

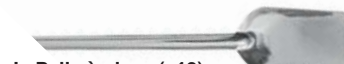

I . Pelle à glace (x12)

Code	Long cm	Sur.	Prix HT
F . 47 10 771	19,5	12	0,51
G . 47 10 472	20	12	2,00
H . 46 10 422	18	12	9,90
I . 47 11 359	10	1	1,93



Q . fourchette tapas



R . Cuillère 3 en 1 Tam Tam



S . Couteau tartineur basic



T . Couteau tartineur soigné

Mobil Pocket

Inox 18.0 avec boîte de rangement



U . Set de 4 couverts

Code	Long cm	Sur.	Prix HT
Q . 48 35 989	12	12	0,31
R . 47 10 713	12	12	0,37
S . 47 35 820	12	12	0,87
T . 47 10 811	15	12	2,09
U . 47 40 151	18	12	5,33



V . Filla

Code	Long cm	Sur.	Prix HT
S . 47 12 026	11	12	0,88
47 12 024	14	12	1,04
47 12 025	18,5	12	1,25



W . Athéna

Code	Long cm	Sur.	Prix HT
T . 47 12 047	10,5	12	0,73
47 12 046	14	12	1,05
47 12 045	19	12	1,70



X . Nature forgé

Code	Long cm	Sur.	Prix HT
U . 47 12 067	18	12	1,75
47 12 066	13,4	12	1,35



Y . Arès

Code	Long cm	Sur.	Prix HT
V . 47 12 081	10,5	12	0,85
47 12 080	13,8	12	0,90
47 12 079	18,5	12	1,45



Z . 47 12 082 20 (soda) 12 2,15

Roissy

1,5mm finition brillante, inox 18.0



AA . Fourchette

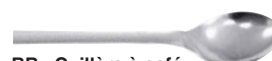

BB . Cuillère à café



CC . Couteau table

Code	Long cm	Sur.	Prix HT
AA . 47 10 894	16	12	0,49
BB . 47 10 896	12	12	0,41
CC . 47 10 897	16,5	12	0,55
<u>Set de 3 pièces (sous film)</u>			
CC . 47 10 914		1	1,48



A . Fourchette gâteau roissy



C . Fourchette huître Bourget



D . Fourchette huître Valmy



E . Cuillère 3 en 1

Code	Long cm	Sur.	Prix HT
A . 47 10 894	16	12	0,49
C . 47 10 449	12,5	12	0,51
D . 48 35 986	13	12	0,32
E . 47 10 713	12	12	0,37



F . Fourchette escargot Bourget



G . Fourchette escargot Valmy

Code	Long cm	Sur.	Prix HT
F . 47 10 445	13	12	0,51
G . 48 35 987	13,5	12	0,46



H . Couteau à beurre



I . Couteau table croco

Code	Long cm	Sur.	Prix HT
H . 47 10 811	14	12	2,09
I . 47 10 711	17	12	0,52



Couteaux à crustacés



J .



K .

Désignation	Code	L x Ht cm	Sur.	Prix HT
J . Manche bakélite	47 10 453	15	12	2,05
Manche soft Touch	50 50 844	4,5 x 16	6	8,17

Pinces à crustacés

Inox 18.0

Inox 18.10



L .



M .

Désignation	Code	Long cm	Sur.	Prix HT
K . Casse noix chromé	47 10 450	15,3	50	5,72
L . Pince crustacés	47 10 452	18	120	19,31

Pics à crustacés

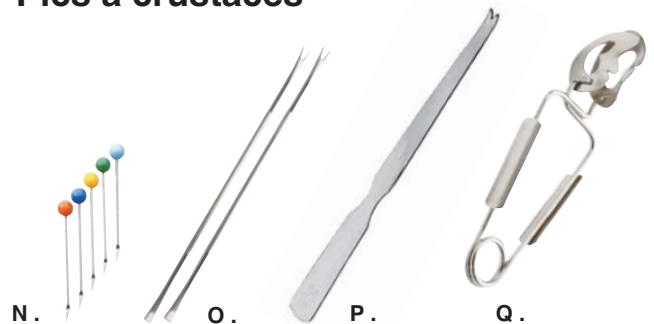

N .

O .

P .

Q .

Désignation	Code	L x Ht cm	Sur.	Prix HT
M . 12 pics à bigorneaux	47 10 446	7,2	1	2,92
N . 12 tirettes à homard	47 10 457	18,5	1	4,32
O . Curette à crustacés	47 10 451	19,8	12	0,97
Q . Pince à escargot	47 10 448	5 x 14	1	4,12

Plat à crustacés et support

épaisseur 0,6 mm



R .



S .



T .

Désignation	Code	Φ x Ht cm	Sur.	Prix HT
R . Plat à crustacés	47 10 458	40 x 5	1	22,87
S . Support	47 10 454	25 x 19	1	10,11
T . Gant silicone Noir	50 40 104	11 x 9	6	2,50





05

ACCESSOIRES ET CUISINE



- Moulins à sel et poivre 239 à 241
- Condiments et accessoires 242 à 243
- Accessoires de cuisine 244 à 249
- Plateaux et services 250 à 251
- Accessoires du bar 252 à 257
- Sets de table 258 à 259
- Couteaux professionnels 260 à 261
- Ustensiles de cuisine 262 à 263
- Pâtisserie 264
- Pesage 265
- Ménage 266 à 267

Hawai



A. Curry



B. Kaki



C. Paprika

QUALITÉ

Fabriqué en fonte de haute qualité, robuste et durable, garantie d'une longévité exceptionnelle. Équipé d'un broyeur en céramique de qualité professionnelle, assure une mouture précise et régulière, préservant l'arôme et la saveur de vos épices.



Code	ø x Ht cm	Sur.	Prix HT
A. 79 11 162	6 x 8	4	36,50
B. 79 11 163	6 x 8	4	36,50
C. 79 11 164	6 x 8	4	36,50

OGO Professionnel Inox



D. Sel



ACIER INOXYDABLE

La fonction et la précision permettent une mouture parfaite des grains. Broyeur en acier carbone. Finition inox soignée.

Code	ø x Ht cm	Sur.	Prix HT
D. 79 11 136	6 x 23	4	24,95



E. Poivre

Code	ø x Ht cm	Sur.	Prix HT
E. 79 11 135	6 x 23	4	24,50



OGO Professionnel Bois

OGO



A . Poivre

B . Sel

C . Poivre

Code	ø x Ht cm	Sur.	Prix HT
A . 79 11 105	6 x 23	6	16,50
B . 79 11 101	5,7 x 15	6	14,95
C . 79 11 115	5,3 x 10	6	10,95

GAMME PROFESSIONNELLE

Dont le design, la fonction et la précision en font un choix sûr et moderne.

Le bouton d'ajustement est moleté pour faciliter la prise.

Pour bien reconnaître le moulin, les lettres «S» et «P» sont imprimées sur le dessus du bouton.

Le moulin est également muni d'un ressort pour assurer que la mouture désirée soit constante.

Broyeur en acier
carbure (poivre)Broyeur en acier
carbure (sel)

Moulins recyclés

ROBUSTE

Fabriqué en bois de hêtre recyclé, ce moulin à poivre en bois est équipé d'un broyeur en acier carbone de qualité professionnelle.

Réglage précis afin d'obtenir une mouture plus ou moins épaisse.

Broyeur en acier
carbure poivreBroyeur en acier
inoxydable sel

D . Sel 23cm

E . Sel 15cm

F . Poivre 23cm

Code	ø x Ht cm	Sur.	Prix HT
D . 79 11 156	6 x 23	4	24,50
E . 79 11 158	5,5 x 15	6	19,50
F . 79 11 155	6 x 23	6	25,50

Moulins à manivelle

VINTAGE ET INNOVATEUR

Broyeur en acier carbone pour les moulins à poivre. Tranchant et durable.
Broyeur en acier inox pour les moulins à sel. Finesse et robustesse.



G . Poivre

H . Sel

Code	ø x Ht cm	Sur.	Prix HT
G . 79 11 145	9,1 x 8,4	6	14,50
H . 79 11 146	9,1 x 8,4	6	14,50

Leo



I . Sel

Code	ø x Ht cm	Sur.	Prix HT
I . 79 11 124	6 x 31	4	23,95
J . 79 11 170	5,3 x 10,5	6	13,50

Muscade



J . Muscade

PROFESSIONNEL

Moulin à noix de muscade à manivelle en bois de hêtre.

Idéal pour râper très finement la noix de muscade.



Moulins à poivre & sel



A . Poivre & Sel

B . Poivre & Sel

C . Poivre & Sel

Code	ø x Ht cm	Sur.	Prix HT
A. 50 50 155	6 x 18,5	6	5,18
B. 50 50 156	6 x 18,5	6	5,18
C. 50 50 157	6 x 18,5	6	5,18

MOULIN COLORÉ

Moulin à sel et poivre doté d'un mécanisme en céramique précis et résistant, avec réglage simple de la mouture. Disponible en coloris céladon, crème et rose clair.



Moulin électrique

MOULIN ÉLECTRIQUE

Moulin électrique 2 en 1, équipé de deux zones pour sel et poivre, avec broyeur céramique précis et corps en acier inoxydable 18/0.



D . Poivre & Sel

Code	ø x Ht cm	Sur.	Prix HT
D . 50 50 165	7 x 21,5	6	11,44

Moulin bois

Moulin en bois de hêtre broyeur céramique.



E . Poivre & Sel

Code	ø x Ht cm	Sur.	Prix HT
E . 50 50 167	6 x 14	6	7,19

Moulin transparent

Moulin en acrylique transparent broyeur céramique.



F . Poivre & Sel

Code	ø x Ht cm	Sur.	Prix HT
F . 50 50 166	6 x 14	6	4,31

Classic

Broyeur en céramique.



G . Sel

H . Poivre

Code	ø x Ht cm	Sur.	Prix HT
G . 50 50 082	5,8 x 10	6	6,95
H . 50 50 083	5,8 x 10	6	6,95

Bois et acrylique

Moulins en plastique transparent et bois naturel.



I . Poivre

J . Sel

Code	ø x Ht cm	Sur.	Prix HT
I . 50 50 064	5,5 x 19,5	6	16,25
J . 50 50 063	5,5 x 19,5	6	14,55

Copa

Moulins en bambou.



K . Sel

L . Poivre

Code	ø x Ht cm	Sur.	Prix HT
K . 50 50 160	5,5 x 10	6	3,11
L . 50 50 161	5,5 x 10	6	3,11

Salières & Poivrières



A . Damier
bouchon plastique



B . Salière verre
bouchon inox

Code	ø x Ht cm	Sur.	Prix HT
A . 75 13 025	4,5 x 8,5	36	1,62
B . 50 40 027	3,8 x 8	12	1,20

Saupoudreuses



C . Saupoudreuse



D . Saupoudreuse

Code	Ccl	ø x Ht cm	Sur.	Prix HT
C . 50 40 025	27	7,2 x 11,5	12	2,55
D . 75 31 022	25	8,6 x 9,3	12	5,77



E . Salière
porcelaine



F . Poivrière
porcelaine



G . Set sel et poivre
porcelaine

Code	ø x Ht cm	Sur.	Prix HT
E . 26 91 330	4,1 x 7,2	10	3,55
F . 26 91 331	4,1 x 7,2	10	3,55
G . 29 40 056	4,5 x 7	3	2,95

Moutardier

À couvercle avec cuillère.



H . Moutardier

Code	ø x Ht cm	Sur.	Prix HT
H . 29 40 057	6,3 x 9	6	3,15



I . Set Eco
3 pièces



J . Set 2 pièces
huile et vinaigre

Code	L x l x Ht cm	Sur.	Prix HT
I . 48 35 680	21,8 x 10,6 x 10	24	8,03
J . 48 35 681	11,4 x 5,3 x 21,6	1	8,93



K . Paris
sel et poivre



L . Ménagère 2
pièces

Code	ø x Ht cm	Sur.	Prix HT
K . 48 35 682	7,8 x 3,7 x 12,8	12	5,33
L . 48 35 743	13,8 x 7,3 x 22,5	24	10,82

Authentica



M . Refermable.
Liège et inox (x2)



N . Bouteille verre
bec verseur inox

Code	Ccl	ø x Ht cm	Sur.	Prix HT
M . 50 41 048		9,2 x 2,3	8	2,65
N . 75 36 342	27,3	5,8 x 26,1	12	5,61
jauge 25 cl au col de la bouteille				
N . 75 36 343	52,5	6,9 x 31,3	12	6,34
jauge 50 cl au col de la bouteille				

Optima

Huile



O .

Vinaigre



P .

Verre, bec verseur en
inox 18/8 joint silicone

Code	L x l x Ht cm	Sur.	Prix HT
O . 75 36 394	7,4 x 5 x 14,3	12	6,64
P . 75 36 395	7,4 x 5 x 14,3	12	6,64



Q . Pot à épices



R . Bouteille d'huile

Code	Ccl	ø x Ht cm	Sur.	Prix HT
Q . 50 40 259		10,5 x 12,9	6	5,00
R . 50 40 258		9 x 21	6	5,70



S . Bouteille d'huile



T . Pulverisateur
d'huile

Code	Ccl	ø x Ht cm	Sur.	Prix HT
S . 50 40 255	50	7,6 x 23,8	6	4,55
T . 50 40 256	25	6 x 18,2	6	4,05



U . Pulverisateur
d'huile



V . Set 3 pots avec
couvercle

Code	Ccl	ø x Ht cm	Sur.	Prix HT
U . 50 39 257	18	7,3 x 22	6	4,55
V . 50 39 075	30	8 x 8,7	6	5,50
W . 50 40 262	75		6	9,40



W . Huilier en
verre

Cendriers



A. Rond empilable transparent



B. Rond empilable transparent



D. Inox avec couvercle



E. Inox rond empilable



H. Vide poche carré blanc



C. Rond empilable noir



F. Inox trou large avec couvercle



G. Inox large



I. Cendrier 2 encoches rectangle blanc

Code	ø x Ht cm	Sur.	Prix HT
A. 16 05 105	10,7 x 3,5	48	1,25
B. 75 14 201	8,5 x 3,5	24	2,08
B. 75 41 229	7,2 x 3,8	24	0,99
C. 75 14 203	8,5 x 3,5	24	2,47

Code	ø x Ht cm	Sur.	Prix HT
D. 46 15 191	11 x 4	12	5,95
E. 46 15 313	8 x 3	6	2,59
F. 46 15 192	12,5 x 4,8	12	3,25
G. 46 15 312	15 x 3	6	2,59

Code	ø x Ht cm	Sur.	Prix HT
H. 29 40 064	10 x 10	6	1,95
I. 29 40 063	12 x 9 x 3	12	1,75



J. Ouvre-boîte carbone



K. Ciseaux de cuisine



L. Râpe de cuisine ronde inox



M. Râpe de cuisine rectangle inox



N. Toqueur à oeuf inox

Code	L x l cm	Sur.	Prix HT
J. 50 25 984	13 x 9 x 3	48	0,93
K. 50 15 416	20 x 7,2	24	1,95

Code	L x l x Ht cm	Sur.	Prix HT
L. 50 41 106	11,5 x 11,5 x 24	6	9,58
M. 50 41 105	10,5 x 8 x 26	6	6,55

Code	Ø x Ht cm	Sur.	Prix HT
N. 50 40 452	5 x 25	12	4,55



O. Plateau addition en inox



P. Support magnétique mural



Q. Barre à notes

Code	L x l x Ht cm	Sur.	Prix HT
O. 46 15 202	15 x 11	1	4,76
P. 46 10 424	42 x 5,2 x 1,5	1	8,29
Q. 46 10 028	62,7 x 2,8 x 7	24	19,85



R. Flora bombé



S. Flora droit



T. Vinciana

Désignation	Code	Ø x Ht cm	Sur.	Prix HT
R. Flora bombé	16 13 860	9 x 27,5	6	4,03
S. Flora droit	16 13 862	11,5 x 26,5	6	4,03
U. Vinciana	16 16 139	22,6 x 23	6	10,07

Deluxe ✨



A. Épluche légumes

B. Éplucheur

C. Économe

Code	L x l x Ht cm	Sur.	Prix HT
A. 50 40 239	7 x 2 x 16,5	12	9,95
B. 50 40 243	7 x 1,4 x 12	12	3,55
C. 50 40 238	3 x 1,4 x 18,7	12	4,95



ÉPLUCHAGE FACILE

Épluche-légumes et économe en plastique noir avec lame inox, conçus pour un épluchage facile et efficace.



FACILE

Coupe-pomme 12 tranches en acier inoxydable, offrant précision et robustesse pour un découpage rapide et uniforme.



D. Coupe pomme



E. Presse ail

Code	L x l x Ht cm	Sur.	Prix HT
D. 50 40 240	17,5 x 5 x 11,7	8	16,25
E. 50 40 235	6 x 3 x 17,2	8	12,45



F. Mandoline avec poignée



G. Mandoline sur pied

Code	L x l x Ht cm	Sur.	Prix HT
F. 50 40 246	38,5 x 13 x 6,5	6	8,95

Code	L x l x Ht cm	Sur.	Prix HT
G. 50 40 245	37 x 13 x 7,4	6	27,95



MANDOLINE MULTIFONCTION

Conçue pour trancher rapidement et uniformément, cette mandoline pliable et antidérapante est équipée d'une lame supplémentaire pour plus de polyvalence.

Deluxe 

Accessoires de cuisine



OUVRE-BOÎTE MULTIFONCTION

Outil polyvalent en acier inoxydable, résistant et ergonomique, conçu pour ouvrir facilement boîtes de conserve, bouteilles et pots sans effort.

A. Ouvre boîte multifonction

Code	L x l x Ht cm	Sur.	Prix HT
A. 50 40 236	5,3 x 6,5 x 20	8	12,46



B. Cuillère à glace

Code	L x l x Ht cm	Sur.	Prix HT
B. 50 40 241	4,5 x 3,4 x 20,5	8	6,75



C. Casse noix

Code	L x l x Ht cm	Sur.	Prix HT
C. 50 40 242	4,5 x 2,4 x 18,6	8	8,90



D. Roulette à pizza

Code	L x l x Ht cm	Sur.	Prix HT
D. 50 40 244	12,2 x 2,5 x 23,5	8	10,27



E. Attendrisseur à viande

Code	L x l x Ht cm	Sur.	Prix HT
E. 50 40 237	5,7 x 5,3 x 17,2	8	14,95



A. 500 mL

B. 1000 mL

C. 1500 mL



D. Set de 2 planches à découper en plastique

Code	Ccl	L x l x Ht cm	Sur.	Prix HT
A. 50 40 521	50	10 x 10 x 8,3	6	4,12
B. 50 40 522	100	10 x 10 x 15,7	6	4,95
C. 50 40 523	150	10 x 10 x 23	6	6,62

Code	L x l x Ht cm	Sur.	Prix HT
D. 50 40 578	34,5 x 24,5 x 0,5 29 x 19 x 0,5	6	5,60



E. Set de 4 boîtes empilables avec couvercles



Boîtes empilables



F. Set de 3 bols à mélanger



G. Set de 3 bols de conservation avec couvercles

Code	L x l x Ht cm	Sur.	Prix HT
E. 50 40 577	18,8 x 13,9 x 6,5	6	3,15

Code	ø x Ht cm	Sur.	Prix HT
F. 50 40 468	13,5 x 21,5	6	11,95

Code	ø x Ht cm	Sur.	Prix HT
G. 50 40 575	20,5 x 19,7 16,5 x 7,7 12,8 x 6,2	6	5,60



H. Mini essoreuse à herbe



K. Cloche micro-ondes



I. Essoreuse à salade 2 en 1



J. Essoreuse à salade



L. Passoire

Code	ø x Ht cm	Sur.	Prix HT
H. 50 40 254	13 x 14	6	5,40
I. 50 40 253	24 x 26	4	18,90
J. 50 40 467	25 x 17	6	15,79

Code	ø x Ht cm	Sur.	Prix HT
K. 50 40 397	36 x 9,5	10	1,96
L. 50 40 465	24 x 12	12	3,89





A. Organisateur d'évier

Code	L x l x Ht cm	Sur.	Prix HT
A. 50 40 137	18 x 13 x 12	6	6,60
B. 50 40 138	17 x 12 x 16	6	7,20



B. Organisateur d'évier 2 en 1



C. Porte-ustensiles

Code	L x l x Ht cm	Sur.	Prix HT
C. 50 40 139	18 x 11 x 19	6	8,05



D. Distributeur de savon en verre

Code	Ccl	ø x Ht cm	Sur.	Prix HT
D. 15 10 245	50	10,5 x 15	6	13,55



E. Égouttoir extensible



F. Panier égouttoir extensible

Code	L x l x Ht cm	Sur.	Prix HT
E. 50 40 096	48-34,5 x 19 x 6,5	6	9,00
F. 50 40 099	48-34,5 x 19 x 6,5	12	3,25



G. Égouttoir avec tapis



I. Egouttoir vaisselle + plateau blanc



H. Égouttoir extensible en polypropylène noir



J. Égouttoir vaisselle métal noir

Code	L x l x Ht cm	Sur.	Prix HT
G. 50 40 094	44 x 16 x 3,5	6	6,85
H. 50 40 091	28 x 20 x 9,5	6	10,95

Code	ø x Ht cm	Sur.	Prix HT
I. 63 41 995	34,5 x 42,5 x 9	12	9,95
J. 50 40 090	35,8 x 30,5 x 14,2	4	9,95



Accessoires de cuisine



**A. Presse citron
Arc verre**



B. Presse agrumes

Code	ø x Ht cm	Sur.	Prix HT
A. 75 16 330	14 x 6,5	12	3,10
B. 50 40 466	15,5 x 10,5	6	4,75



C.



D.

Presse citron

Code	L x l x Ht cm	Sur.	Prix HT
C. 50 40 265	22,3 x 7,4 x 5	6	4,55
D. 50 40 266	23,5 x 9,3 x 6,5	6	6,65



E.



F.

Bac à 12 glaçons

Code	L x l x Ht cm	Sur.	Prix HT
E. 65 15 088	24,5 x 11 x 3,5	12	1,45
F. 50 40 859	30 x 9,4 x 4	12	2,19



G. Mandoline rotative

Code	L x l x Ht cm	Sur.	Prix HT
G. 50 40 248	24,5 x 11,5 x 27	6	27,95



H. Mandoline verticale

Code	L x l x Ht cm	Sur.	Prix HT
H. 50 40 249	26 x 12 x 38	6	18,90



I. Hachoir à ail



Code	Ø x Ht cm	Sur.	Prix HT
I. 50 40 268	8,9 x 22,5	6	6,65



J. Moulin à coulis

Code	L x l x Ht cm	Sur.	Prix HT
J. 15 10 329	40 x 21 x 20	8	19,95



K. Entonnoir confiture

Code	L x l x Ht cm	Sur.	Prix HT
K. 15 10 332	14 x 21,7 x 8,2	12	1,95



L. Hachoir à viande manuel

Code	L x l x Ht cm	Sur.	Prix HT
L. 15 10 328		6	29,95



M. Entonnoir inox avec filtre

Code	L x l x Ht cm	Sur.	Prix HT
M. 15 10 341	15 x 13 x 11	10	9,85



A. Kit machine sous vide

Code	L x l x Ht cm	Sur.	Prix HT
A. 15 10 345	37 x 14,6 x 5,5	1	94,95



B. Pompe à main sous vide

Code	ø x Ht cm	Sur.	Prix HT
B. 15 10 346	6 x 19,5	20	26,95
C. 15 10 347	10 x 4	48	8,75



C. Set de 2 couvercles avec valve sous vide



D. Set de 20 sacs zippés avec valve sous vide

Code	L x l cm	Sur.	Prix HT
D. 15 10 385	20 x 30	6	14,85
D. 15 10 386	25 x 35	6	17,45



E. Set de 50 sacs de conservation sous vide gauffrés

Code	L x l cm	Sur.	Prix HT
E. 15 10 387	15 x 20	30	7,45
E. 15 10 388	16 x 24	30	6,05
E. 15 10 389	20 x 30	20	9,95
E. 15 10 390	28 x 40	10	23,65



F. Set de 2 rouleaux de film sous vide gauffré

Code	L x l cm	Sur.	Prix HT
F. 15 10 391	17 x 500	25	10,45
F. 15 10 392	28 x 500	25	15,65



G. Bocal avec couvercle en bois

Code	Ccl	ø x Ht cm	Sur.	Prix HT
G. 15 10 292	58	10 x 12,5	6	4,80
G. 15 10 291	42,5	10 x 9,5	6	4,50
G. 15 10 290	25,5	8,8 x 7,5	6	3,95



H. Déshydrateur électrique

Code	L x l x Ht cm	Sur.	Prix HT
H. 15 10 348	36,5 x 33 x 27,8	1	165,00

Planches à découper en bois d'acacia

novastyl



Code	L x l x Ht cm	Sur.	Prix HT
A. 50 40 984	55 x 16 x 1,5	10	9,95
B. 50 40 986	50 x 20 x 1,5	10	9,95



Code	L x l x Ht cm	Sur.	Prix HT
C. 50 40 987	45 x 17 x 1,5	10	8,95
D. 50 40 960	50 x 24 x 1,5	6	10,25



Code	L x l x Ht cm	Sur.	Prix HT
E. 50 40 962	72 x 28 x 1,5	6	16,65
F. 50 40 961	55 x 18 x 1,5	6	8,85



Code	L x l x Ht cm	Sur.	Prix HT
G. 50 40 963	48 x 24 x 1,5	6	9,95
H. 50 40 964	48 x 17 x 1,5	6	7,95



Code	L x l x Ht cm	Sur.	Prix HT
I. 50 40 965	40 x 16,5 x 1,5	6	7,65
J. 50 40 966	48 x 16,5 x 1,5	6	8,95



Code	L x l x Ht cm	Sur.	Prix HT
K. 50 40 973	33 x 12,5 x 1,5	6	2,45
L. 50 40 972	50 x 12,5 x 1,5	6	3,55
M. 50 40 971	80 x 12,5 x 1,5	6	5,45



N . Planche à découper
+ 3 couteaux



O . Planche à découper
décor boeuf

Code	L x l x Ht cm	Sur.	Prix HT
N. 50 40 967	49 x 16 x 2	8	14,45
O. 50 40 974	51 x 36 x 2,2	4	21,95



P . Support à
essuie-tout



Q . Planche
à pizza

Code	L x l x Ht cm	Sur.	Prix HT
P. 50 40 978	15 x 15 x 33	6	4,75
Q. 50 40 975	40,5 x 30 x 1,5	6	10,85

Planches de présentation



Planches Agora en bois de hêtre

Code	L x l cm	Sur.	Prix HT
A . 26 32 898	33 x 24	1	37,59
B . 26 32 899	37 x 24	1	51,71



Planches Agora en bois de hêtre

Code	L x l x cm	Sur.	Prix HT
C . 26 32 900	41 x 24	1	61,89
D . 26 32 901	45 x 24	1	69,14



Dessous plat



H . Dessous plat métal I . Dessous plat Hêtre

Code	ø. x Ht cm	Sur.	Prix HT
H . 65 15 165	20 x 1,5	1	1,45
I . 65 15 167	15 x 0,9	1	3,15

Planches à découper



F . Planche à découper en polypropylène

Code	L x l cm	Sur.	Prix HT
F . 50 45 400	38 x 23,5	20	9,95
F . 50 45 401	31 x 19,5	20	6,55
F . 50 45 407	25 x 15,5	20	4,55



G . En polyéthylène haute densité

Code	L x l cm	Sur.	Prix HT
G . 46 11 863	50 x 30	6	42,60



F . Set 2 couverts à salade



G . Planche à découper en polypropylène

Code	L x l x Ht cm	Sur.	Prix HT
F . 50 40 968	8 x 8 x 30,5	6	8,50
G . 50 40 969	30,5 x 30,5 x 10	6	17,85

Plateaux mélamine - Bayadère



Plateau 49 x 30 cm



Plateau 35 x 26 cm

Code	Couleur	L x l x Ht cm	Sur.	Prix HT
6317280	Vert	49 x 30 x 3	6	6,04
6317281	Rouge	49 x 30 x 3	6	6,04
6317282	Bleu	49 x 30 x 3	6	6,04
6317283	Orange	49 x 30 x 3	6	6,04
6317284	Jaune	49 x 30 x 3	6	6,04

Code	Couleur	L x l x Ht cm	Sur.	Prix HT
6317275	Vert	35,6 x 26 x 4	6	4,55
6317276	Rouge	35,6 x 26 x 4	6	4,55
6317277	Bleu	35,6 x 26 x 4	6	4,55
6317278	Orange	35,6 x 26 x 4	6	4,55
6317279	Jaune	35,6 x 26 x 4	6	4,55

Saucière inox



A . Saucière 14.5cl

Code	Ccl	L x Ht cm	Sur.	Prix HT
A. 46 15 305	14,5	18 x 8,5	6	4,75

Pots à lait inox



B . Pots à lait

Code	Ccl	Ø x Ht cm	Sur.	Prix HT
B. 46 15 306	35	7 x 8	6	3,65
B. 46 15 307	60	9 x 10,5	6	4,95
B. 46 15 308	90	9 x 12,5	6	6,25
B. 46 15 309	120	10 X 14,5	6	6,75

Plateaux inox

novastyl



C . Plateaux

Code	L x l cm	Sur.	Prix HT
C. 46 15 326	40 x 31	6	8,95

Seaux à champagne inox Seaux à glace inox



D . Seau à champagne

Code	Ccl	L x Ht cm	Sur.	Prix HT
D. 46 15 453		22 x 21	6	7,50

Inox 18.10



E .

Code	L x Ht cm	Sur.	Prix HT
E. 47 37 020	11,5 x 11	12	25,48
F. 46 15 347	20 X 21	6	6,95



F . Seau à anses



G . Rafraîchisseur bouteilles

Code	L x Ht cm	Sur.	Prix HT
G. 46 15 348	12 X 20	6	11,65

Vasque à champagne

Support de table

UTILE

Permet de garder au frais son champagne, son pétillant ou encore son vin. Ce modèle est muni de poignées pour faciliter le transport. L'acier inoxydable est un matériau durable, résistant à la corrosion et facile à nettoyer.

PRATIQUE

Grande vasque à champagne permettant de contenir jusqu'à 6 bouteilles. Pratique et élégante avec son socle stable.



H . Inox isotherme

Code	Ccl	Ø x Ht cm	Sur.	Prix HT
H. 46 15 349	150	15,5 x 15,5	6	18,95



I . Vasque à champagne

Code	L x Ht cm	Sur.	Prix HT
I. 46 15 260	40 x 22	6	23,95



J . Support seau à champagne

Code	Ccl	L x Ht cm	Sur.	Prix HT
J. 46 10 437	80	22 x 12	1	13,75

Plateaux inox



A . Plat uni ovale

Code	L x l cm	Sur.	Prix HT
A. 47 10 426	27 x 17	6	7,25
A. 47 10 428	34 x 22	1	9,12
A. 47 10 429	38 x 25	12	11,99
A. 47 10 430	40 x 27	12	13,05
A. 47 10 431	46 x 30	1	14,62
A. 47 10 432	60 x 24	25	19,22



B . Plat rond inox uni

Code	Ø cm	Sur.	Prix HT
B. 47 37 100	30	6	12,48
B. 47 37 101	34	6	14,38



C . Plat ovale

Code	L x l cm	Sur.	Prix HT
C. 47 10 402	30 x 18	1	7,03
C. 47 10 403	35 x 20	1	8,66
C. 47 10 404	40 x 23	1	9,59



D . Plateau rond



F . Plat gratin ovale inox



H . Ramequin inox forme basse



E . Barman rond inox soigné



G . Plat gratin rectangle inox



I . Ramequin inox forme haute

Code	Ø cm	Sur.	Prix HT
D. 46 15 332	40	6	7,65
E. 46 15 200	40	12	17,36

Code	L x l cm	Sur.	Prix HT
F. 47 37 124	Ø 38 x 23	6	20,19
G. 47 37 130	30 x 21	6	18,47
G. 47 37 131	37 x 25	6	21,30

Code	Ccl	Ø x Ht cm	Sur.	Prix HT
H. 47 10 589	4,5	6 x 2,5	50	0,86
I. 47 10 590	7,5	5,7 x 4,2	50	0,97
J. 47 10 591	12	6,6 x 4,7	50	1,09
J. 47 10 592	23,5	6 x 9,5	50	3,25



K . Légumier Régence



L . Saladier «Cul de poule»



M . Passoire



M . Corbeille à pain inox



N . Corbeille à pain inox

Code	Ccl	Ø x Ht cm	Sur.	Prix HT
K. 47 10 415	115	22 x 5,8	1	11,05
L. 46 15 298	500	29 x 14	6	7,95
L. 46 15 297	370	24 x 12	6	6,01
L. 46 15 296	150	19 x 9	6	3,85
L. 46 15 295	75	15 x 8	6	2,45

Code	L x l cm	Sur.	Prix HT
M. 46 15 344	26 X 17	6	8,60

Code	Ø x Ht cm	Sur.	Prix HT
M. 46 15 345	18 X 8	24	3,67
N. 46 15 346	20 x 10,5	24	4,25

œnologie



A . Tire-bouchon Deluxe

Code	L x l x Ht cm	Sur.	Prix HT
A. 79 11 225	15 x 4 x 11,5	6	31,50

INCLUS
Livre de recettes
Guide mesure
Couvercle hermétique



B . Shaker

Code	ø. x Ht cm	Sur.	Prix HT
B. 79 11 228	26,5 x 8,5	6	37,50

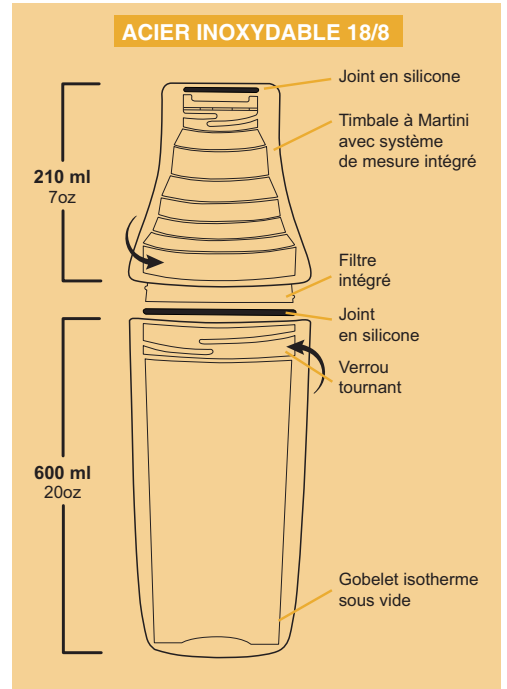

OUVERTURE FACILE

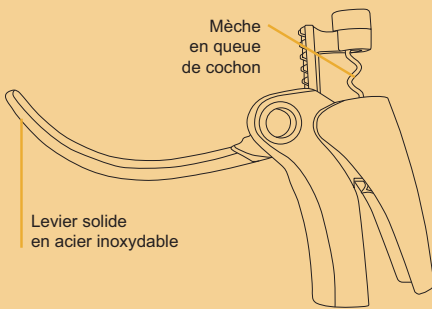

L'acier inoxydable est un matériau durable, résistant à la corrosion et facile à nettoyer. Ce tire-bouchon ajoute une touche de sophistication à chaque dégustation.



C . Tire-bouchon De Gaulle

Code	ø. x Ht cm	Sur.	Prix HT
C. 79 11 238	7,3 x 19,2	8	9,50



D . Tire-bouchon à vis

E . Tire-bouchon sommelier

Code	ø. x Ht cm	Sur.	Prix HT
D . 79 11 232	20 x 1,5	8	5,95
E . 79 11 230	15 x 15	12	11,50

POLYVALENCE

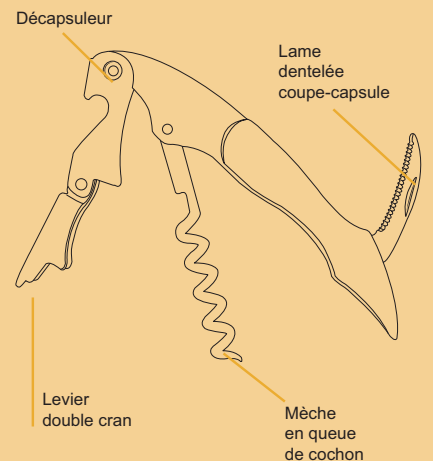

ÆNOLOGIE

New collection by Ogo



OGO
Living



RAPIDE

Simple à utiliser, il révèle le bouquet aromatique de vos vins.



A . Aérateur à vin

B . Aérateur bec verseur

Code	ø. x Ht cm	Sur.	Prix HT
A. 79 11 237	7,5 x 10	6	6,50
B. 79 11 241	3,7 x 16,5	8	5,25



C . Rafraîchisseur vin

PRATIQUE

Ajuster la température facilement tout en gardant la bouteille fermée. S'adapte à la plupart des bouteilles de vin.



D . Thermomètre



Code	L x l x Ht cm	Sur.	Prix HT
C . 79 11 231	15,5 x 3 x 22,5	8	8,95

Code	ø. x Ht cm	Sur.	Prix HT
D . 79 11 236	7,5 x 4	6	9,50



RAPIDE

Accessoire indispensable pour servir le vin à la température idéale. Il permet de refroidir rapidement une bouteille sans utiliser de glace, préservant ainsi les arômes et les saveurs. Idéal pour des moments improvisés ou pour garder le vin parfaitement frais tout au long du repas.

CONSERVATION

La pompe à vin aide à retirer l'air de la bouteille ou à augmenter la pression pour le champagne, permettant ainsi de prolonger leur durée de conservation et de préserver les saveurs.

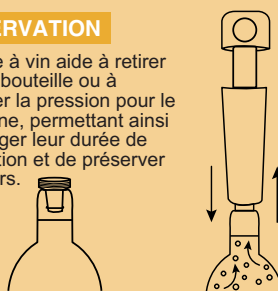

E . Pompe à vin + bouchons

Code	ø. x Ht cm	Sur.	Prix HT
E. 79 11 234	4 x 18	8	7,50

CONSERVATION

Aussi utiles qu'élégants, ces bouchons hermétiques en acier inoxydable préservent la fraîcheur et les arômes de chacune de vos bouteilles de vin préféré.



A . Bouchon à vin



B . Bouchon à champagne



C . Décapsuleur

Code	L x l x Ht cm	Sur.	Prix HT
A . 79 11 229	2,6 x 2,6 x 7	12	5,50
B . 79 11 239	4 x 4 x 5,6	12	2,95
C . 79 11 233	4,5 x 12 x 16,2	12	4,85



FACILE

Des accessoires indispensables pour ôter proprement capsule de bouteille et bouchons de champagne.



D . Coupe-capsule



E . Ouvre-champagne

Code	ø x Ht cm	Sur.	Prix HT
D . 79 11 226	6,2 x 2,1	12	5,75
E . 79 11 227	6,8 x 4,3	12	5,25



F . Limonadier 3 en 1



G . Bec verseur



H . À Levier



I . Limonadier 4 pièces

Code	L x l x Ht cm	Sur.	Prix HT
F . 79 11 242	3,8 x 2,7 x 14	12	5,80
G . 79 11 235	4 x 3 x 10,5	12	6,50

Code	ø. x Ht cm	Sur.	Prix HT
H . 50 41 021	26	12	5,69
I . 50 25 969	rouge ou bleu	12	1,73



J . Verre + bouchon plastique

Code	Ccl	Ø x Ht cm	Sur.	Prix HT
J . 10 29 100	58,5	8 x 16,5	6	12,85

Sets de table

Bali

Jonc de mer



Désignation	Code	Ø cm	Sur.	Prix HT
-------------	------	------	------	---------

Bali	63 17 045	38	6	5,55
------	-----------	----	---	------

Tissé

Papier et coton naturel



Couleur	Code	Ø cm	Sur.	Prix HT
---------	------	------	------	---------

Noir	63 17 140	36	144	2,95
------	-----------	----	-----	------



Siam

Jacinthe d'eau



Désignation	Code	L x l cm	Sur.	Prix HT
-------------	------	----------	------	---------

Siam	63 17 046	45 x 30	12	5,95
------	-----------	---------	----	------

Luna

Jonc de mer



Couleur	Code	Ø cm	Sur.	Prix HT
---------	------	------	------	---------

Bleu	63 17 575	38	6	4,50
Terra	63 17 576	38	6	4,50
Vert	63 17 577	38	6	4,50

Dune

Cloche en jonc de mer



Couleur	Code	Ø x Ht cm	Sur.	Prix HT
---------	------	-----------	------	---------

Safran	63 17 598	33 x 17	1	40,83
--------	-----------	---------	---	-------

Java

Jacinthe d'eau



Désignation	Code	Ø cm	Sur.	Prix HT
-------------	------	------	------	---------

Java	63 17 047	38	12	5,95
------	-----------	----	----	------

Iris

Jonc de mer



Couleur	Code	Ø cm	Sur.	Prix HT
---------	------	------	------	---------

Bleu	63 17 592	38	6	14,50
Safran	63 17 591	38	6	14,50
Vert	63 17 590	38	6	14,50

Dune

Corbeilles à pain en jonc de mer



Couleur	Code	L x l x Ht cm	Sur.	Prix HT
---------	------	---------------	------	---------

Bleu	63 17 595	20 x 14 x 7	6	22,50
Safran	63 17 597	18 x 18 x 7	6	22,50
Vert	63 17 596	20 x 20 x 7	6	22,50

novastyl

New products
Nouveautés

Tissage

PVC tissé



Désignation	Code	L x l cm	Sur.	Prix HT
Rouge	63 17 105	45 x 30	12	1,55
Bleu	63 17 106	45 x 30	12	1,55
Noir	63 17 107	45 x 30	12	1,55

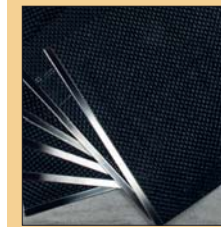

FINITION

Set de table avec bordures en acier inoxydable 18/10, assurant une excellente tenue sur la table.

PVC tissé

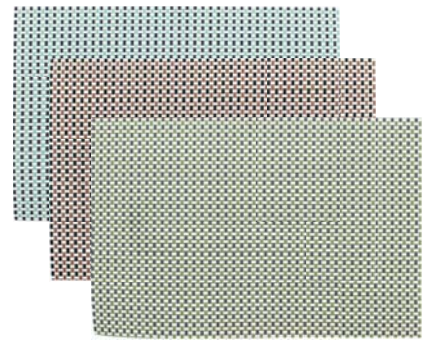

Désignation	Code	L x l cm	Sur.	Prix HT
Bleu	63 17 147	45 x 30	12	1,95
Rouge	63 17 148	45 x 30	12	1,95
Vert	63 17 149	45 x 30	12	1,95

Vinyl

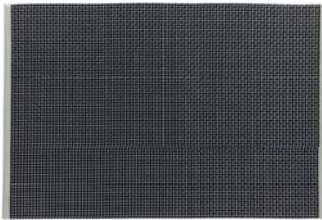

Pvc



Désignation	Code	L x l cm	Sur.	Prix HT
Vinyl Noir	63 17 710	45 x 30	12	3,15
PVC Marron	63 17 055	45 x 30	12	2,95

Jute Naturel



Couleur	Code	L x l cm	Sur.	Prix HT
Blanc	63 17 095	45 x 30	144	1,95
Gris	63 17 096	45 x 30	144	1,95
Marron	63 17 097	45 x 30	144	1,95

Leave

PEVA souple



Bistrot

Toile de jute.



Désignation	Code	L x l cm	Sur.	Prix HT
Leave	63 17 072	43,5 x 28,5	12	1,67
Bistrot	63 17 740	45 x 30	12	2,50

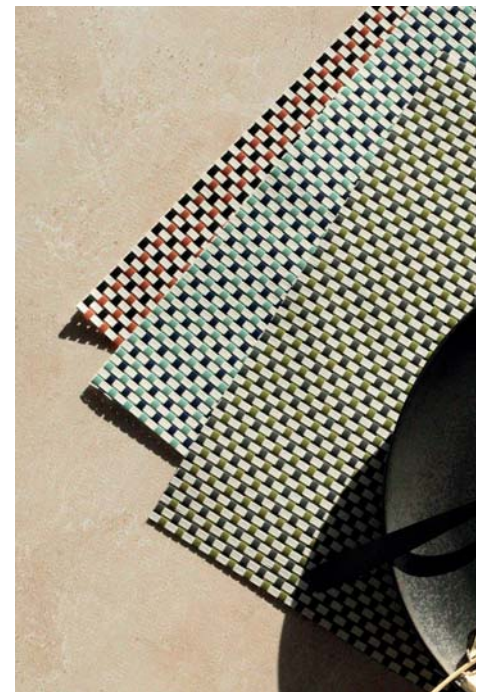

Ica

Plastique effet cuir



Désignation	Code	L x l cm	Sur.	Prix HT
Marron	63 17 078	43 x 30	12	3,75
Vert	63 17 077	43 x 30	12	3,75
Noir	63 17 076	43 x 30	12	3,75

Couteaux professionnels

Origin

QUALITÉ

Maître Chef : lame acier inoxydable pleine soie trempé, mitre forgée. Manche Pom, 3 rivets traversants.

SABATIER
TROMPETTE



Code	épaisseur mm	Long lame cm	Sur.	Prix HT
A . 46 10 690	2,5	10	1	11,11
B . 46 10 359	2,5	13	1	15,57
C . 46 10 360	1,8	18	1	16,67
D . 46 10 361	2,5	20	1	17,79
E . 46 10 717	3	17	1	17,17
F . 46 10 340	2,5	18	1	20,13
G . 46 10 355	3	15	1	20,40

Code	épaisseur mm	Long lame cm	Sur.	Prix HT
H . 46 10 701	2,5	30	1	13,56
I . 46 10 356	3	20	1	21,33
J . 46 10 357	3	25	1	24,76
K . 46 10 358	3	30	1	29,97
L . 46 10 362	2,5	25	1	22,29
M . 46 10 691	2	28	1	19,11
N . 46 10 395	1,5	18	1	10,65
O . 46 10 719	4	18	1	19,95



QUALITÉ

Couteaux ligne proclassique manche ABS noir avec rivets. Acier trempé lame rivetée transversale, tranchant haute précision.

Artisan



Code	épaisseur mm	Long lame cm	Sur.	Prix HT
P . 47 10 129	1,2	9	1	2,99
Q . 47 10 130	1,2	11,5	1	1,68
R . 47 35 588	1,2	10	1	3,63
S . 47 10 131	1,2	15	1	4,71
T . 47 40 124	1,2	18	1	5,00
U . 47 10 132	1,8	20	1	5,86

Code	épaisseur mm	Long lame cm	Sur.	Prix HT
V . 47 10 134	1,8	20,5	1	5,26
W . 47 35 589	1,8	20,5	1	5,41
X . 47 10 135	1,8	29	1	5,90
Y . 47 35 590	1,8	18	1	6,38
Z . 47 35 591	1,5	25	1	6,65
AA . 46 10 675	1,8	25	1	8,43
BB . 47 10 136	1,8	29	1	5,59

Studio



A . Éplucheur



C . Office



E . Pain studio



B . Chef Merlon



D . 3 rivets grillade



F . Office 3 rivets

Code	Long lame cm	Sur.	Prix HT
A . 47 35 017	lame 21	24	1,85
B . 47 35 016	lame 21	24	1,95

Code	Long lame cm	Sur.	Prix HT
C . 47 35 022	19	12	1,04
D . 47 35 094	19	12	0,74

Code	Long lame cm	Sur.	Prix HT
E . 47 10 263	21,5	12	1,04
F . 50 25 987	16	96	0,60

Flex manche surmoulé

SABATIER
TROMPETTE®

QUALITÉ

Acier X30Cr13, lame flexible. Mitre inox. Manche moulé PP. Insert amovible couleur. 12 spatules incontournables pour les usages en pâtisserie et en grill. Les 5 embouts colorés HACCP fournis permettent de différencier les spatules en fonction de leur usage et ainsi d'éviter les contaminations croisées.



A . Triangle lame large



E . Large courbée



I . Flexible poisson



B . Grillades plate



F . Lisse



J . Spatule droite



C . Courbée



G . Perforée



K . Spatule droite



D . Large courbée



H . Large courbée



L . Spatule droite



M . Spatule droite

Code	L x l x Ht cm	Sur.	Prix HT
A . 46 10 718	13	1	9,60
B . 46 10 399	22 x 15	1	10,78
C . 47 35 265	48 x 25	1	8,03
D . 47 35 269	22	1	10,59

Code	L x l x Ht cm	Sur.	Prix HT
E . 47 35 266	28 x 5	1	12,25
F . 46 10 397	21,5 x 7,5	1	5,75
G . 46 10 398	21,5 x 7,5	1	5,65
H . 47 35 268	34	1	13,53

Code	L x l x Ht cm	Sur.	Prix HT
I . 46 10 396	30 x 8	1	4,80
J . 47 35 261	25	1	7,63
K . 47 35 262	30	1	8,39
L . 47 35 263	35	1	9,36
M . 47 35 264	40	1	9,96

Pinces

PRATIQUE

Idéale pour le service des aliments et les barbecues. Résistantes à la chaleur.



A . Pince de service



C . Pince multi-usage inox



D . Pince à glaçons

Code	Longueur cm	Sur.	Prix HT
A . 46 10 510	30	12	9,40

Code	Longueur cm	Sur.	Prix HT
C . 50 40 539	23	12	2,55
D . 46 11 910	19	1	2,78



Buffet Martin inox 18.10, 3mm



A . Cuillère à spaghetti

B . Cuillère à sauce

C . Cuillère à service

D . Pince à servir

E . Pelle à tarte

F . Pelle à frire

G . Louche

H . Louchette

I . Fourchette à salade

J . Cuillère à salade

Code	Long cm	Sur.	Prix HT
A . 47 37 035	30,8	1	12,18
B . 47 37 036	20,7	1	8,33
C . 47 37 037	31,7	1	10,25
C . 47 37 047	30	1	7,69

Code	Long cm	Sur.	Prix HT
D . 47 37 039	10,5	1	7,85
E . 47 37 040	25,9	1	7,00
F . 47 37 041	31,7	1	10,25

Code	Long cm	Sur.	Prix HT
G . 47 37 042	31	1	12,18
H . 47 37 043	26	1	10,35
I . 47 37 045	30	1	7,69
J . 47 37 038	31	1	7,87

Monobloc 18.0



K . Araignée 18.10

L . Louche 18.10

M . Fouet Exoglass

Code	Ccl	L x Ht cm	Sur.	Prix HT
K . 46 10 384	24 x 45	1	35,65	
K . 46 10 385	66,7 x 28	1	41,80	

Code	Ccl	L x Ht cm	Sur.	Prix HT
L . 46 10 374	7	6,5 x 28	1	9,40
L . 46 10 375	12	8 x 30	1	10,65
L . 46 10 376	20	10 x 38	1	14,75
L . 46 10 377	50	12 x 38	1	15,45
L . 46 10 378	75	14 x 45	1	19,50
L . 46 10 379	100	16 x 56	1	22,75

Code	Long cm	Sur.	Prix HT
M . 46 10 363	25	1	12,45
M . 46 10 364	30	1	14,40

Monobloc 18.0



N . Cuillère à servir

O . Fourchette

P . Louche Valmy



Q . Pelle à tarte unie

R . Inox

Code	Long cm	Sur.	Prix HT
N . 47 10 441	24,5	1	1,98
O . 47 10 443	24,5	1	1,98
P . 47 10 455	28	1	2,68

Code	Long cm	Sur.	Prix HT
Q . 47 10 020	25	1	2,05
R . 50 40 541	20	1	1,45
R . 50 40 542	25	12	1,55
R . 50 40 543	30	12	1,95

Nylon noir



S . Louche

T . Cuillère à sauce

U . Écumoire

V . Pelle à servir

Code	Long cm	Sur.	Prix HT
S . 65 15 031	29	1	1,60
T . 65 15 032	29	1	1,60
U . 65 15 033	28	1	1,60
V . 65 15 034	29	1	1,60

Eliott



A . Maryse B . Spatule cuillère C . Spatule

Code	Long cm	Sur.	Prix HT
A . 50 40 186	32	12	3,95
B . 50 40 183	32	12	3,95
C . 50 40 181	32	12	3,95



D . Spatule ajourée E . Cuillère F . Cuillère ajourée

Code	Long cm	Sur.	Prix HT
D . 50 40 182	32	12	3,95
E . 50 40 188	31,5	12	3,95
F . 50 40 185	31,5	12	3,95
G . 50 40 189	27	12	3,95



G . Pinceau H . Louche I . Cuillère à pâtes J . Fouet

Code	Long cm	Sur.	Prix HT
H . 50 40 184	31,5	12	3,95
I . 50 40 180	31,5	12	3,95
J . 50 40 187	25	12	3,95

MATIÈRE

Silicone de qualité alimentaire et bois de hêtre.



Range couverts

Polypropylène gris, GN 1/1, 4 compartiments.



M. N. Couverture base GN 1/1



K . Cuillère L . Spatule biseautée

Code	Long cm	Sur.	Prix HT
K . 60 10 162	35	12	1,00
K . 60 10 163	30	12	0,95
L . 60 10 161	30	12	0,90

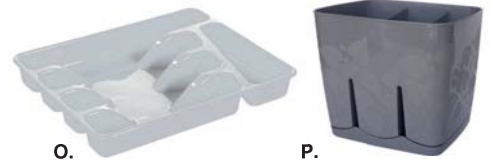

O. P.

Code	Prof.	L x l cm	Sur.	Prix HT
M . 65 15 455	9	52 x 32	10	10,45
N . 65 14 454		53,7 x 33,2		8,50
O . 63 40 653	13	32,5 x 25	10	2,90
P . 63 40 652	12	11,5 x 13,8	6	3,55

Casiers de lavage

PROFESSIONNEL

Compatibles et empilables avec la grande majorité des marques de casiers. Existe en 16, 25, 36 et 49 cases.



Code	Casiers 50 x 50 x 10,3	Sur.	Prix HT
16 compartiments			
46 10 250	ø int. max. 11,2	6	29,50
46 10 251	réhausse x ht 4,5 cm	12	12,20
25 compartiments			
46 10 252	ø int. max. 9 cm	1	30,95
46 10 253	réhausse ht 4,5 cm	12	12,95
36 compartiments			
46 10 254	ø int. max. 7,4 cm	6	32,65
46 10 255	réhausse ht 4,5 cm	12	12,95
49 compartiments			
46 10 256	ø int. max. 6 cm	6	34,75
46 10 257	réhausse ht 4,5 cm	12	13,80
Casier assiettes			
46 10 258	avec picots	6	24,20
Casier universel			
46 10 264	base open rack	6	24,40
Rehausse sans compartiment			
46 10 266		12	11,25

Verres doseurs novastyl



A . Verre doseur en verre (2 coloris assortis)

Code	Ccl	l x Ht. cm	Sur.	Prix HT
A . 16 05 085	45	8,9 x 14,6	6	2,50

ARCOROC



B . Verre mesureur Arc C . Doseur en verre kitchen lab

Code	Ccl	l x Ht. cm	Sur.	Prix HT
B . 75 16 345	58,5	8 x 16	6	3,85
C . 14 50 124	25	12 x 14	10	4,98
C . 14 50 125	50	11 x 13	6	6,99
C . 14 50 126	75	9 x 10	6	8,13

PYREX



D . Verre mesureur borosilicate E . Broc mesureur borosilicate

Code	Ccl	l x Ht. cm	Sur.	Prix HT
D . 14 50 123	50	10 x 17	6	6,50
E . 14 50 121	50	17 x 12	6	7,41

Thermomètres de cuisine



F . Verre doseur Précicio

Code	Ccl	ø x Ht cm	Sur.	Prix HT
F . 13 10 155	56	9 x 14,8	12	5,26



G . Broc mesureur avec couvercle

Code	Ccl	ø x Ht cm	Sur.	Prix HT
G . 14 50 127	100	21 x 16	6	11,62



I . Thermomètre sonde électronique

Code	Amplitude	EC	Sur.	Prix HT
I . 50 41 043	14-22,5	0,02	6	8,55



J . Thermomètre plastique pour congélateur

Code	Amplitude	EC	Sur.	Prix HT
J . 46 12 030	-50 +50°C		50	2,95



K . Jatte Classic

Code	Ccl	L x l x Ht. cm	Sur.	Prix HT
K . 14 50 119	300	24 x 13	6	9,37
K . 14 50 118	200	21 x 11	6	7,35
K . 14 50 117	100	17 x 10	12	5,30
K . 14 50 116	50	14 x 8	12	3,76



PRATIQUE

Idéal pour la réalisation de crème brûlée.



L . Chalumeau culinaire

Code	ø. x Ht cm	Sur.	Prix HT
L . 47 10 880	10 x 19	1	24,33



M . Cuillère Électronique

Code	Long cm	EC	Sur.	Prix HT
M . 79 15 050	23	0,02	12	12,85

ASTUCIEUX

Cette cuillère à mesurer est équipée d'un mini système de pesage pour cuisiner avec précision. Portée 300 g, graduation 0,1 g. Affichage LCD. ABS et acier inoxydable. Arrêt automatique.



Balances électroniques ■ Garantie 5 ans

SOEHNLE



A . Compact noir



B . Compact gris



C . Page Profi 100

Code	Grad. gr	EC	Sur.	Prix HT
------	----------	----	------	---------

A . 08 61 515 1 0,06 6 18,32

Portée 5 kg. Forme compacte et extra plate 20 x 15 x 1,3 cm. Affichage LCD 12 mm. Technologie Sensor Touch brevetée. Fonctionne avec 1 pile lithium CR 2430 fournie.

Code	Grad. gr	EC	Sur.	Prix HT
------	----------	----	------	---------

B . 08 61 516 1 0,06 6 18,32

Code	Grad. gr	EC	Sur.	Prix HT
------	----------	----	------	---------

C . 08 61 506 1 0,11 4 31,96

Portée 15 kg. Plateau de pesée extra large 24 x 17,5 cm. Affichage LED Blanc 22 mm. Technologie Sensor Touch brevetée. Fonctionne avec 3 piles 1,5 V AAA fournies.



D . Comfort 400



**E . Page Profi 200
inox**



F . Page Profi 300

Code	Grad. gr	EC	Sur.	Prix HT
------	----------	----	------	---------

D . 08 61 505 1 0,11 4 23,96

Portée 10 kg. Grand plateau en verre 22 x 22 x 1,8 cm. Technologie Sensor Touch brevetée. Affichage de l'heure en mode veille.

Code	Grad. gr	EC	Sur.	Prix HT
------	----------	----	------	---------

E . 08 61 509 1 0,11 4 38,36

Portée 15 kg. Large surface 24 x 17,5 cm. En acier inoxydable haute qualité. Technologie Sensor Touch. Revêtement anti-traces de doigts. Fonctionne avec 3 piles 1,5 V fournies.

Code	Grad. gr	EC	Sur.	Prix HT
------	----------	----	------	---------

F . 08 61 507 1 0,11 4 35,96

Portée 20 kg. Grand plateau 27 x 20 cm. Très grand affichage LCD 25 mm. Technologie Sensor Touch brevetée. Fonction HOLD : le poids reste affiché même après la pesée. Fonctionne avec 3 piles 1,5 V AAA fournies.



**G . Balance électronique
inox**

Code	Grad. gr	EC	Sur.	Prix HT
------	----------	----	------	---------

G . 62 11 016 1 0,13 6 9,90

Portée 5 kg. Surface 18 x 14 cm. En acier inoxydable haute qualité. Écran LCD. Fonctionne avec 2 piles AAA fournies.



Pèse-personnes

■ Garantie 5 ans



**H . Balance électronique
inox**

Code	Grad. gr	Sur.	Prix HT
------	----------	------	---------

H . 06 61 098 1000 4 19,96

Portée 130 kg. Châssis en acier. Surface antidérapante avec revêtement en caoutchouc.

Balais et accessoires



A . Ens. seau 12 L + essoreur rectangle + manche 1,20 m av. mop

Code	Sur.	Prix HT
A . 63 40 646	40	8,85
B . 65 15 061	30	6,55

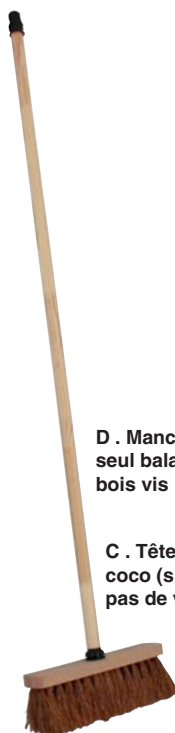

D . Manche seul balai bois vis Fr

C . Tête seule balai coco (s'adapte sur pas de vis Fr)

B . Ens. balai coco + manche bois vis Fr

Code	Long cm	Sur.	Prix HT
C . 65 15 183	28	12	3,30
D . 65 15 184	120	1	3,25
E . 65 15 062		12	6,35



F . Tête seule balai brosse (s'adapte sur pas de vis Fr)

E . Ens. balai lave-pont + manche bois vis Fr



G . Ens. balai nylon + manche plas.

Code	Long cm	Sur.	Prix HT
F . 65 15 189	22	12	3,70
G . 63 40 670	120	60	3,45
H . 63 40 666		12	3,30



H . Pelle + balayette gris foncé



I . Tête seule balai nylon (sur manche 6515184)

Code	Long cm	Sur.	Prix HT
I . 65 15 187	30	12	3,30
J . 65 15 038	30	12	2,10



J . Tête seule balai nylon frontier



K . Raclette métallique

Code	Long cm	Sur.	Prix HT
K . 65 15 322	35	10	2,30
L . 65 15 316		25	1,99
M . 65 15 128	6,5	1	1,25



L . Tête mop seule coton embout vis française



M . Brosse vaisselle



N . Serpillère coton

Code	L x l cm	Sur.	Prix HT
N . 65 15 181	50 x 100	30	3,45
O . 65 15 318	60 x 50	30	2,35



O . Serpillère coton



P . Essoreur seul



Q . Seau mop rectangle 12 L

Code	L x l x Ht cm	Sur.	Prix HT
P . 63 40 645	13,5 x 16 x 12	15	1,65
Q . 63 40 644	21 x 38 x 25,5	15	4,60
R . 65 15 008	31 x 13	1	1,75

R . Essoreur seul



S . Seau rond à bec 12 L

Code	Litres	Ø x Ht cm	Sur.	Prix HT
S . 65 15 105	12	27,5 x 26,5	10	4,25
T . 63 40 642	4	26 x 12	1	2,55



T . Bassine ronde



U .



V .

Support + brosse WC

Code	Sur.	Prix HT
U . 63 40 673	20	2,10
V . 63 40 665	20	2,10

Poubelles & corbeilles



A . Oscar

B . Klip

C . Corbeille à papier

D . Seau + couvercle

Code	Litres	ø x Ht cm	Sur.	Prix HT
A . 63 40 660	7	20 x 29	8	5,50
B . 63 40 658	26	27 x 34 x 51	6	14,55
B . 63 40 657	12	22 x 26 x 40	8	9,05

Tapis



E . Tapis caoutchouc

Code	Litres	Lx l x Ht cm	Sur.	Prix HT
C . 63 40 659		28 x 28	15	2,90
D . 63 40 662	16	30 x 30	10	5,65

Code	L x l cm	Sur.	Prix HT
E . 65 15 093	37 x 51	10	7,95

Cintres & pinces



F . Anneau antiviol pour cintres

G . Cintre plastique antiviol

H . Cintre plastique jupe antiviol

I . Cintres plastique noir pince jupe

J . Cintre plastique noir avec tête en métal

Code	Long cm	Sur.	Prix HT
F . 65 15 112		1	0,40
G . 65 15 111	42	250	0,85

Code	Long cm	Sur.	Prix HT
H . 65 15 205	42	150	1,60
I . 65 15 090	36	5	1,05

Code	Long cm	Sur.	Prix HT
J . 65 15 204	40	1	0,80

Étendage



M . Séchoir tour Rennes (3 niveaux)

Code	L x l x Ht cm	ECO	Sur.	Prix HT
M . 65 15 326	74 x 69 x 126	0,22	4	36,95



K . Cintre en bois de hêtre vernis

Code	Long cm	Sur.	Prix HT
K . 65 15 438	44	5	1,65



L . Sachet 24 pinces à linges plastique multicolores

Code	Sur.	Prix HT
L . 63 41 989	1	2,65



N . Séchoir linge Vulcano

Code	L x l x Ht cm	ECO	Sur.	Prix HT
N . 65 15 324	180 x 55 x 100	0,22	6	28,05



O . Table à repasser Lyra (ajustable de 76 à 92 cm)

Code	L x l x Ht cm	ECO	Sur.	Prix HT
O . 65 15 443	110 x 34 x 92	0,22	4	60,20



Ensemble Montauk

L'ensemble à manger Montauk séduit par son design moderne, sa forme conviviale et son élégante teinte Brique.



Fauteuil de bar Amalfi

Le fauteuil de bar Amalfi allie finesse moderne et solidité, idéal pour des espaces élégants.



Fauteuil de table Eros

Le fauteuil de table Eros associe un tissu doux à une structure en métal doré, pour un rendu élégant et équilibré.



Fauteuil Hella

Le fauteuil Hella combine une assise confortable en tissu bouclette et une structure en bois de frêne.



06

MOBILIER



Fauteuils de table extérieurs	270
Mobilier extérieur	271 à 273
Fauteuils de table intérieurs	274 à 276
Fauteuils Lounge	277 à 279

Amalfi & Capri

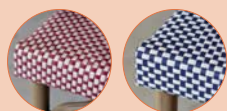

Disponible en Rouge et Bleu



Ht. 46 cm

Fauteuil de table Amalfi



Ht. 46 cm

Fauteuil de table Capri



REVÊTEMENT

Textilène tissé

STRUCTURE

Aluminium + Rotin synthétique

Désignation	Coloris	Code	L x l x Ht cm	SUR.	Prix HT
Amalfi	Naturel	72 24 388	57 x 57 x 82	2	141,25
	Rouge	72 24 384	57 x 57 x 82	2	141,25
	Bleu	72 24 386	57 x 57 x 82	2	141,25
Capri	Naturel	72 24 380	49 x 42 x 93	2	166,25



Ht. 46 cm

Chaise Amalfi beige



REVÊTEMENT

Textilène tissé

STRUCTURE

Aluminium + Rotin synthétique

Désignation	Coloris	Code	L x l x Ht cm	SUR.	Prix HT
Chaise Amalfi	Beige	72 24 402	50 x 57 x 85	2	128,75



Désignation	Coloris	Code	L x l x Ht cm	SUR.	Prix HT
Fauteuil bar Amalfi	Naturel	72 24 394	41 x 57 x 112	2	164,58
	Rouge	72 24 390	41 x 57 x 112	2	164,58
	Bleu	72 24 392	41 x 57 x 112	2	164,58
Tabouret bar Amalfi	Naturel	72 24 382	35 x 35 x 74	2	82,92

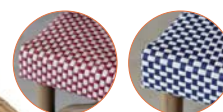

Disponible en Rouge et Bleu



Ht. 75 cm

Fauteuil de bar Amalfi



Ht. 74 cm

Tabouret de bar Amalfi

Napoli



Chaise longue Napoli

Désignation	Coloris	Code	L x l x Ht cm	SUR.	Prix HT
Chaise longue Napoli	Corail	72 28 076	193 x 62 x 34	2	208,29
	Vert	72 28 078	193 x 62 x 34	2	208,29
	Blanc	72 28 080	193 x 62 x 34	2	208,29
	Taupe	72 28 082	193 x 62 x 34	2	208,29



Patio



Salon de jardin Patio

Désignation	Coloris	Code	SUR.	Prix HT
Salon Patio	Vert	72 28 135	1	495,83
	Brique	72 28 136	1	495,83



Ensemble de jardin Patio

Désignation	Coloris	Code	SUR.	Prix HT
Ensemble Patio	Vert	72 28 143	1	665,83



Calypso

Disponible en Brique & Ocre



Canapé : 131 x 74 x Ht. 74 cm
 Fauteuil : 79 x 71 x Ht. 72 cm
 Table : 80 x 45 x Ht. 45 cm

Salon de jardin Calypso

Désignation	Coloris	Code	SUR.	Prix HT
Salon Calypso	Vert	72 28 140	1	579,17
	Brique	72 28 141	1	579,17
	Ocre	72 28 142	1	579,17



ASSISE & DOSSIER

Polypropylène

TABLE

Métal

PIEDS

Métal



TABLE

Métal

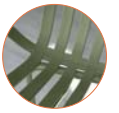
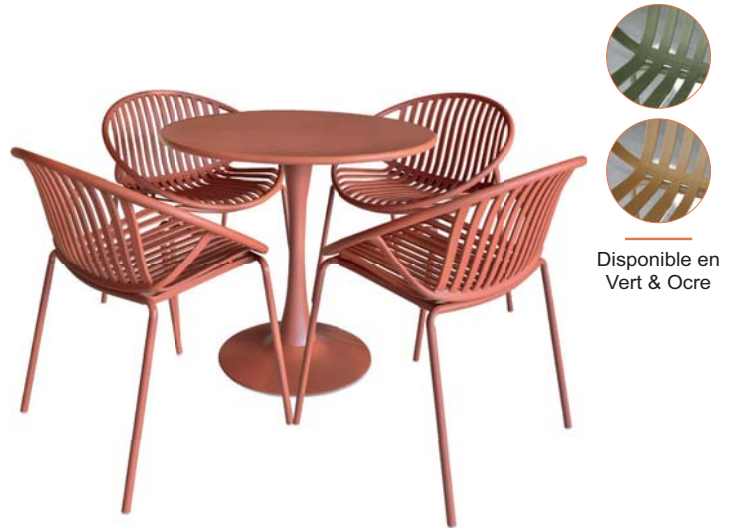

Disponible en Vert & Ocre

Ensemble de jardin Calypso

Désignation	Coloris	Code	SUR.	Prix HT
Ensemble Calypso	Vert	72 26 360	1	582,50
	Brique	72 26 361	1	582,50
	Ocre	72 26 362	1	582,50



Disponible en Vert & Brique

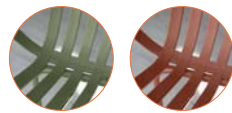

Ht. 46 cm

Fauteuil de table Calypso

Table Bel Air



Désignation	Coloris	Code	L x l x Ht cm	SUR.	Prix HT
Fauteuil Calypso	Vert	72 26 346	65 x 58 x 78	4	83,13
	Brique	72 26 348	65 x 58 x 78	4	83,13
	Ocre	72 26 350	65 x 58 x 78	4	83,13
Table Bel Air	Vert	72 26 310	80 x 80 x 72,5	1	249,17
	Brique	72 26 311	80 x 80 x 72,5	1	249,17
	Ocre	72 26 312	80 x 80 x 72,5	1	249,17

Montauk

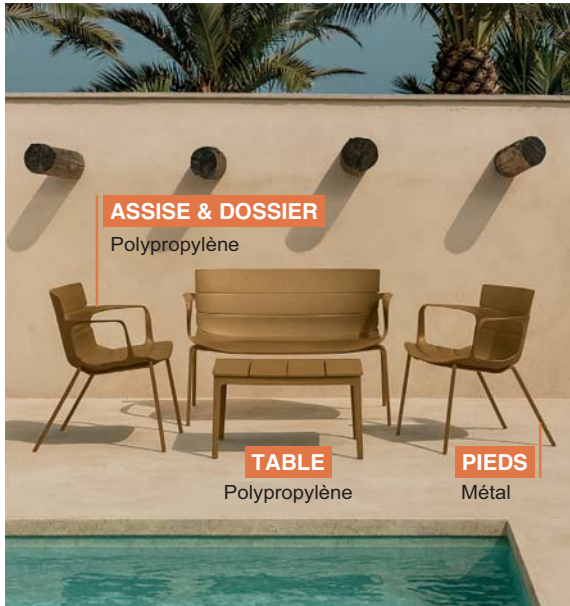

ASSISE & DOSSIER

Polypropylène

TABLE

Polypropylène

PIEDS

Métal



Disponible en
Brique & Ocre



Disponible en
Vert & Brique



Canapé : 110 x 60 x Ht. 70,5 cm
Fauteuil : 60 x 60 x Ht. 70,5 cm
Table : 70 x 53 x Ht. 38,5 cm

Salon de jardin Montauk

Désignation	Coloris	Code	L x l x Ht cm	SUR.	Prix HT
Salon Montauk	Vert	72 28 137	?	1	579,17
	Brique	72 28 138	?	1	579,17
	Ocre	72 28 139	?	1	579,17



Ensemble de jardin Montauk

Désignation	Coloris	Code	SUR.	Prix HT
Ensemble Montauk	Vert	72 26 355	1	582,50
	Brique	72 26 356	1	582,50
	Ocre	72 26 357	1	582,50



Ht. 45 cm

Fauteuil de table Montauk

Désignation	Coloris	Code	L x l x Ht cm	SUR.	Prix HT
Fauteuil Montauk	Vert	72 26 340	55,5 x 57,5 x 80	4	83,13
	Brique	72 26 342	55,5 x 57,5 x 80	4	83,13
	Ocre	72 26 344	55,5 x 57,5 x 80	4	83,13

Gina

STRUCTURE

Métal noir peint par poudrage



Ht. 49 cm

Chaise Gina Moka

Chaise Gina Beige

Désignation	Coloris	Code	L x l x Ht cm	SUR.	Prix HT
Chaise Gina	Moka	72 24 490	50 x 49,5 x 79	2	149,58
	Beige	72 24 492	50 x 49,5 x 79	2	149,58



REVÊTEMENT

Polyester Tweed texturé



Ht. 42 cm

Ht. 67 cm

Fauteuil Lounge Gina Beige

Chaise Bar Gina Beige

Désignation	Coloris	Code	L x l x Ht cm	SUR.	Prix HT
Fauteuil Lounge Gina	Beige	72 24 496	62 x 75,5 x 68	1	245,83
Chaise Bar Gina	Beige	72 24 494	47,5 x 58,5 x 95,5	2	164,58

Ginette



REVÊTEMENT

Polyester Tweed texturé



Ht. 48,5 cm

Fauteuil de table Ginette



Désignation	Coloris	Code	L x l x Ht cm	SUR.	Prix HT
Ginette	Tabac	72 24 480	58 x 63,5 x 84	1	165,83

Eros



Fauteuils de table

Now'S
HOME
FRANCE



Disponible en
Brique



Ht. 47,5 cm

Fauteuil de table Eros

Désignation	Coloris	Code	L x l x Ht cm	SUR.	Prix HT
Fauteuil Eros	Latte	72 24 435	57,7 x 56,3 x 84,5	2	142,25
	Brique	72 24 437	57,7 x 56,3 x 84,5	2	141,25
	Ecrû	72 24 439	57,7 x 56,3 x 84,5	2	141,25

Maia



DOSSIER

Bois effet noyer



Ht. 46,5 cm

Chaise Maia

Désignation	Coloris	Code	L x l x Ht cm	SUR.	Prix HT
Chaise Maia	Latte	72 24 442	50 x 58 x 83	2	166,25

Gaston



Ht. 46 cm

Chaise Gaston Écrû

Chaise Gaston Châtaigne

Désignation	Coloris	Code	L x l x Ht cm	SUR.	Prix HT
Chaise Gaston	Écrû	72 24 445	42,5 x 56,5 x 78,5	2	125,00
	Châtaigne	72 24 447	42,5 x 56,5 x 78,5	2	125,00



REVÊTEMENT

Tissu Tweed

STRUCTURE

Métal noir



ASSISE

Tissu bouclette Écrû

ASSISE

Tweed Marron

Chaises de table

Nosara



Disponible en
finition naturelle



Disponible en
finition noire



Ht. 46 cm

Chaise Nosara



Ht. 72 cm

Chaise de bar Nosara

Désignation	Coloris	Code	L x l x Ht cm	SUR.	Prix HT
Chaise Nosara	Naturel	72 24 334	47 x 53 x 82	2	103,75
	Noir	72 24 336	47 x 53 x 82	2	103,75
Chaise bar Nosara	Naturel	72 24 330	45 x 50 x 99	2	124,58
	Noir	72 24 332	45 x 50 x 99	2	124,58



Now'S
HOME
FRANCE



ASSISE + DOSSIER
Finition noyer

Gaspard



Chaise Gaspard Marron



Ht. 45 cm

Chaise Gaspard Noire

Désignation	Coloris	Code	L x l x Ht cm	SUR.	Prix HT
Gaspard	Marron	72 24 340	49 x 57,5 x 82,5	2	141,25
	Noir	72 24 342	49 x 57,5 x 82,5	2	141,25

Riva



Chaise Riva Terracotta



Ht. 46,5 cm

Chaise Riva Écru



ASSISE
Velours
côtelé

DOSSIER
Finition noyer

Désignation	Coloris	Code	L x l x Ht cm	SUR.	Prix HT
Chaise Riva	Terracotta	72 24 344	51 x 52 x 73,5	2	124,58
	Écru	72 24 346	51 x 52 x 73,5	2	124,58

Funky

Fauteuils Lounge

Now'S
HOME
FRANCE



Fautueil Funky Safran

Code	L x l x Ht cm	SUR.	Prix HT
72 24 485	62 x 74 x 75	1	249,17



Fautueil Funky Beige

Code	L x l x Ht cm	SUR.	Prix HT
72 24 486	62 x 74 x 75	1	249,17

Ht. 42 cm



Fautueil Funky Terracotta

Code	L x l x Ht cm	SUR.	Prix HT
72 24 487	62 x 74 x 75	1	249,17



Fautueil Funky Vert



Fautueil Funky Rose

Désignation	Coloris	Code	L x l x Ht cm	SUR.	Prix HT
Fautueil Funky	Vert	72 24 488	62 x 74 x 75	1	249,17
	Rose	72 24 489	62 x 74 x 75	1	249,17



REVÊTEMENT
Velours côtelé

PIED
Métal noir



Sixties



Fauteuil pivotant Sixties

Désignation	Coloris	Code	L x l x Ht cm	SUR.	Prix HT
Fauteuil Sixties	Ocre	72 24 369	77 x 74 x 80	1	540,83

Ulysse



Fauteuil Ulysse



Pouf Ulysse



Désignation	Coloris	Code	L x l x Ht cm	SUR.	Prix HT
Fauteuil Ulysse	Beige	72 24 370	72 x 75 x 73,5	1	415,83
Pouf Ulysse	Beige	72 24 371	64 x 44 x 45	1	165,83

Hella



Fauteuil Hella



Désignation	Coloris	Code	L x l x Ht cm	SUR.	Prix HT
Fauteuil Hella	Blanc	72 24 424	70 x 72 x 72	1	632,50

Yack



Ht. 47 cm

Fauteuil Yack Beige



Fauteuil Yack Cappuccino

Désignation	Coloris	Code	L x l x Ht cm	SUR.	Prix HT
Fauteuil Yack	Beige	72 24 420	71 x 79 x 77	1	832,50
Fauteuil Yack	Cappuccino	72 24 421	71 x 79 x 77	1	832,50



REVÊTEMENT

Tissu effet mouton

STRUCTURE

Bois de frêne

Artic

Disponible
en Bleu



Ht. 42 cm

Fauteuil Artic

Désignation	Coloris	Code	L x l x Ht cm	SUR.	Prix HT
Fauteuil Artic	Blanc	72 24 422	76 x 81 x 77	1	649,17
Fauteuil Artic	Bleu	72 24 423	76 x 81 x 77	1	649,17



REVÊTEMENT

Tissu effet
fourrure

PIEDS

Bois noir

A	
1920 America	37
1960 Roma	21
Abondance carafe	78
Accademia Luigi Bor	19
Accessoires Silicone	216
Achille steak	235
Acier carbone plat	199
Acrylique moulines	241
Adam	78
Addition plateau	243
Adonis	226
Adonis Icy givré	226
Adventure	53
Aérateur verseur	256
Aère gobelet	71
Agora planches	251
Agora saladiers	117
Airfryer plats	205
Alaska porcelaine	137
Alaska tasses	168
Albus	115
Alhambra	114
Alkemist	26
Allegra	46
Allegra Focus	46
Alu cuisson	191
Alu forgé poêles	190
Alu Pro Menastyl	186
Amalfi fauteuil	270
Amande Riga	167
Amandine Colorama	199
Amandine moules	200
Amatxi	135
Ambassador porcelaine	138
Ambassador tasses	168
Ambassador vap	46
Amber vap	44
Ambition couverts	227
Ambre grès	131
Amélia Vap	34
America 1920	37
Amerika théière	162
Amestista double paroi	167
Amestista Chopes	68
Amovible Easynox	183
Amovibles Menastyl	184
Amsterdam chope	72
Amsterdam couverts	222
Anchor Onis	53
Angélique cadre	199
Animaux de la forêt	127
Anse carafes	78
Anti vent cendrier	243
Antidérapant	154
Antivol cintres	266
Aqua	128
Aquitania Nova	148
Araignées inox	262
Aras chopes	160
Arc Broc	77
Arcade	64
Arcade Ambition	227
Arcadie	64
Arcole Bol	147
Arcopal	149
Arcoroc trempé	64
Arcoroc Vap	34
Arcuisine plats	204
Arès	236
Arès couverts	231
Arès Vintage couverts	231
Ariane couverts	229
Aristo Carré vap	52
Aroma tasses	167
Aronal	98
Arosa chope apéro	71
Artisan	260
Artisan couteaux	235
Assiette mélamine	154
Assiette salade	156
Astral vap	13
Atelier carafes	76
Athens couverts	229
Atome	122
Attendrisseur viande	245
Aura Bonna	121
Aurum chopes	36
Aurum vap	36
Authentica bouteilles	74
Autonomy assiettes	148
Autonomy chope	148

B	
Bac glaçons	248
Bach chopes	20
Bach cocktail	20
Bach vap Luigi	20
Bacs Gastronorme	202
Bacs polypropylène	203
Baguette Amefa	231
Baguette OGO	234
Bake & Enjoy	207

Balais	266
Balances électroniques	265
Ballon Arcoroc	32
Ballon banquet	47
Ballon Cabernet	11
Bamboo Tiki	60
Bambou couteau steak	235
Bambou couverts	226
Banquet vap Ballon	47
Bar OGO	254
Baril gobelet	161
Barman plateau	253
Barracuda	23
Barre aimantée	243
Barre notes	243
Barshine	39
Bartender flûtes	38
Bartender mules	60
Barware Chopes	20
Basic Mug	167
Bassine confiture	196
Batch cooking	209
Bayadere plateaux	251
Bec verseur OGO	257
Becs verseur Optima	242
Beige Octave	198
Beige Urus	90
Bel Air table	272
Belek	49
Belfesta (ex Pure)	15
Beurrier verre	157
Bière chopes	54
Bière chopes anses	55
Bière verres à pied	55
Bistro Martini	57
Bistro vap	47
Bistrot Bormioli	77
Bistrot Le Parfait	213
Black Evolution	150
Blanc marmite	197
Blender Pro	218
Bleu brush	149
Bleu Faustine	132
Bleu Kuwae	154
Bleu Urus	90
Bloom Bonna	120
Blue Jean's Opal	149
Bocal bois	249
Bocaux	213
Bocaux Bistrot	213
Bocaux Le Parfait	214
Bocaux LPS	214
Bock à bière	55
Bock Opal	151
Bocks thé verre	167
Bodega Bonita	71
Bodega chopes	67
Bois bocal	249
Bois ménagères	227
Bois moulines	240
Boîte de 4 verres	69
Boîtes avec couvercles	211
Boîtes borosilicate	211
Boîtes Food box	209
Boîtes sous vides	218
Bol Opal	151
Bol Oslo	147
Bol pasta	144
Bola tasses	168
Bols à pâtes	144
Bols grès	167
Bols mise en bouche	156
Bols Opal	151
Bols pasta porcelaine	143
Bols plastique	246
Bongo steak	231
Bonita	48
Bonna	114
Bonna Albus	115
Bonna grès vitrifié	120
Bonna pizzas	114
Bonna plats	156
Boral OGO	99
Bordeaux Opal	149
Bormioli Luigi	18
Borosilicate	208
Boston shots	160
Botanic	125
Botanica carafe	78
Bouchon optima	74
Bouchons vin	257
Bouilloire électrique	219
Boule pichets	77
Boule thé	166
Bouteilles Authentica	242
Bouteilles Elixir	74
Bouteilles fraîcheur	215
Bouteilles Swing Top Lps	215
Brasseur	49
Brio moulines	241
Brio vap flûtes	57
Britannia Bock	55
Brixton chopes	63
Broadway colors	31
Broadway vap	31
Broc Arc	77

Broc Bistrot	77
Broc mesure	264
Brocs pichets	77
Brosse balai	266
Brosse vaisselle	266
Brosse WC	266
Brush Opal	149
Buffet Martin	262
Byzance porcelaine	126

C	
C & S flûtes	30
Cabana couverts	232
Cabernet Ballon	11
Cabernet cocktail	56
Cabernet flûtes	59
Cabernet Tulip	11
Cabernet Vin Jeunes	10
Cadres acier	199
Café Gourmand Bonna	120
Cafeino Duos	167
Cafeteria porcelaine	147
Cafetière électrique	219
Cafetières borosilicate	166
Caffeino Bormioli	160
Cake moules acier	200
Cake O Cuisine	204
Cake Octave	198
Caldera	45
Calice tasses	137
Calices Timeless	40
Calypso salon	272
Calypso sets salon	272
Campagnard bois couteau	235
Campagne bol	156
Campus Arcoroc	65
Canisse couverts	226
Cannelle	190
Cannelle Ménastyl	190
Capri fauteuil	270
Capri vap	44
Capria	134
Capsules Familia Wiss	215
Capsules pots confiture	215
Caracas feston	151
Caractère couverts	234
Carafe Exclusiva	38
Carafe infuser	164
Carafe Timeless	41
Carafes	74
Carafes Atelier	76
Carafes décanter	78
Carafes Misure	76
Carafons vin Arc	75
Caravelle	72
Carbone porcelaine	140
Carlton	228
Carpaccio porcelaine	146
Carré Alaska porcelaine	137
Carré Aristo vap	52
Carré carafes Arc	75
Carré coupelles	139
Carré Opal restaurant	148
Carré porcelaine	139
Carré saladiers Duralex	157
Carré saladiers porcelaine	139
Carré tasses empilables	139
Casablanca chopes	61
Casablanca Mise en bouche	160
Casiers lavage	263
Casse noix	245
Casse patte crustacés	237
Casserolles inox	182
Casserolles inox	185
Casserolles inox Pro	180
Cassis saladiers	209
Céladon boîtes	210
Céladon cuisson	188
Celebrazione	37
Cendrier inox	243
Cendriers	243
Cendriers empilables	243
Céramique OGO	99
Cerf	127
Cerise casserolles	191
Cerise cuisson	191
Cerveuse Arc	55
Ceylan verre thé	167
Chafing Dish	218
Chaise Amalfi	270
Chaise Bar	274
Chaise longue	271
Chaises	276
Chalumeau culinaire	264
Champagne calice	19
Chardonnay Supremo	21
Charlotte grès	133
Charnière moules	199
Chef & Sommelier gobelets	8
Chef couteaux	260
Chef et Sommelier	4
Chef Saladiers	153
Cherry brush	149
Chianti Supremo	21

Chicago	61
Chiller	57
Chinoise cuiller	156
Chiquito trempé	158
Chopes bière	55
Chopes facettes	68
Chuletero steak	234
Cilindrique double paroi	167
Cintres	266
Ciseaux	243
City carafe	73
Classic cocottes	205
Classic filet or porcelaine	140
Classic jattes	264
Classic Trudeau	241
Classic verre mesure	264
Classico vap Zwiesel	17
Clémentine	211
Cloche micro-ondes	246
Club Novastyl	71
Cocktail America	37
Cocktail Gourmand Bonna	57
Cocktail Cabernet	37
Cocktail calice	37
Cocktail cuillers	236
Cocktail Mondial	14
Cocktails	57
Coco balai	266
Cocoon saladiers	153
Cocotte verre	205
Cocotte volaille	208
Cocottes grès blanc	155
Cocottes Pyrex	205
Cognac vap Arc	54
Cognac vap Mondial	54
Colette cocottes fonte	194
Colorama	188
Colors Broadway	31
Colosseo Vap	39
Comfort balance	265
Compact balance	265
Compotiers	147
Compotiers porcelaine	156
Compotir vap	47
Confituriers	215
Congélation plat	206
Conique mini	72
Conique Onis	53
Conique ramequin	157
Conique Timeless	41
Coniques chopes	63
Conservation	206
Conservation boîtes	210
Consommé bol	168
Consommé bols Opal	151
Contour couverts	223
Cook & Freeze	206
Cook & Heat	206
Cook and Enjoy Pyrex	207
Copa moulines	241
Copa planches	250
Coquetiers	155
Coquille Saint Jacques	155
Corbeille papier	266
Corbeilles pain	154
Corbeilles pain jonc	258
Corps Chauffe	218
Coudé cuillers	236
Coulis moulin	248
Coupe Brio	57
Coupe Disco	56
Coupe dish White	150
Coupe élégance	33
Coupe Evolution	150
Coupe Symétrie	7
Coupelles Boral	98
Coupelles cafeteria	147
Coupelles carré	157
Coupelles Opal	151
Coupelles porcelaine	139
Coupelles So Urban	209
Coupelles Venus	94
Couperet Universal	260
Coupes grès blancs	156
Courbé spatule	261
Couscoussier	195
Couteau hûtre	237
Couteaux Artisan	260
Couteaux cuisine	260
Couteaux hûtre	155
Couteaux manche bois	235
Couteaux steak	232
Couteaux steak manche noir	235
Couteaux Studio	261
Coutellerie	260
Couvercle GN Bacs	202
Couvercle GN1/1 plast	263
Couvercle Octuose	158
Couvercles Familia Wiss	215
Couvercles GN polypro	203
Couvercles saladiers	209
Couvercles silicone	196
Couverts Nature	233
Couverts salade bois	251
Couverts set 4 pièces	236
Couvre confitures	215
Couzon plats inox	253

Crachoir	17
Crème Colorama	188
Crème cuisson	189
Crème moules	199
Crémier inox	252
Crémiers blanc	77
Crêpière Colorama	189
Creuse coupe Bonna	120
Creuse coupe porcelaine	137
Creuses Autonomy	148
Creuses pastas porcelaine	145
Croco couteaux	237
Cross Stack Up	63
Crustacés	237
Crystall Glass Arcoroc	31
Cuiller bois	263
Cuiller chinoise	156
Cuiller glace	245
Cuiller mesure	264
Cuiller servir inox	262
Cuillère glace	236
Cuillers nylon	262
Cuisine couteau	260
Cul de poule saladiers inox	154
Cuvette	266
Cylindriques tasses Opal	151

D

Daily Baguette	231
Damier salière	242
Décapsuleur	257
Découper couteaux	260
Dégustation vap Cognac	54
Delta	104
Deluxe	244
Demi-Sphérique	159
Derin coupelles verre	159
Deshydrateur	249
Desosser couteaux	260
Diamant Estrella	43
Diamant Maeva	159
Diamante	19
Diamond chope	67
Diamond color	67
Diamond coupe	158
Diamond mini	158
Diapason	260
Disco vap	29
Distinction vap	8
Distributeur savon	247
DOC vap	18
Domaine vap	35
Dome plat tarte	152
Doseur Pyrex	264
Double paroi chopes	167
Double paroi tasses	164
Draft vap	50
Drakkar couverts	224
Dream flûte	58
Dublino shot Bormioli	160
Dune corbeilles	258
Dune grès	129
Duos double paroi	167
Duralex	66
Duralex assiettes	152
Duralex Picardie	66

E

East White	116
Easy Inox	184
Easynox	182
Ebro bol	151
Eco couverts	222
Ecriture marmite	197
Eden	51
Egouttoir vaisselle	247
EGP porcelaine	138
Electra chope	69
Elegance Novastyl	71
Elegance Vap	33
Eliott	263
Elisa gobelets	34
Elisa Vap	34
Elisir bouteilles	74
Ellipse cabernet	82
Elysia Pasa	43
Email friteuse	197
Email réactif	126
Emaux réactifs	95
Emerald Primary	9
Emperor Steak	235
Empilable Duralex	66
Empilable gobelets	61
Empilable Novastyl	48
Empilable saladiers	153
Empilable verrine	160
Empilables saladiers	153
Empilables tasses	168
Endeavor chopes	53
Enoteca vap Pasa	46
Ensemble carafe	76
Entonnoir confiture	248

Entonnoir inox	248
Enzo OGO	162
Eplucheur cuisine	261
Equip Home vap	32
Escargot fourchette	155
Escargots plats	155
Eskale chopes	65
Eskale mise en bouche	161
Esméralda couverts	232
Espagnol ensemble	266
Esprit chopes	52
Essence Pasa	44
Essential cocotte	205
Essential Pyrex	207
Essoreur mop	266
Essoreuses salade	246
Este Bormioli Rocco	62
Estrella	43
Etiquettes Le Parfait	215
Etna RCR	26
Etruria Tiki	27
Europa porcelaine	138
Ever vap Classico	17
Every Day	150
Evidence vap	9
Evolution Black	150
Exalt Sensation	10
Exaltation flûtes	59
Exaltation vap	8
Exclusiva vap	38

F

Facets	53
Facile Inox	182
Faïence Amatxi	135
Faïence Capria	134
Faitout First	185
Faitout Triply	177
Familia Wiss	214
Faustine Bleu	132
Faustine Rose	133
Fauteuil bar	270
Fauteuil bouclette	278
Fauteuil Calypso	272
Fauteuil lounge	274
Fauteuil Montauk	273
Fauteuil pivot	277
Fauteuil pivotant	278
Fauteuil table	275
Feston	151
Fiesta cocktail	55
Fil dessous plat	251
Filet bordeaux Opal	149
Filet or porcelaine	140
Filla OGO	234
Film rouleaux	249
Financiers moules	201
Finesse Nude	45
First alu	187
First Inox	185
Fizz Bach	20
Fizz Novecento	38
Fizz Roma	21
Flan moule	155
Flex spatules	261
Flora vases	243
Floral Noir	132
Florence vap	49
Floriant Bormioli	37
Fluid carafes	75
Fluid Frosted	75
Fluté verre	13
Flûtes champagne	59
Flûtes cristallin	59
Flûtes point mousse	37
Flûtes Tre Sensi	36
Focus Allegra	46
Fond lourd chope	72
Fond piqué flûte	59
Fondue assiettes	144
Fontaine verre	60
Fonte tajines	195
Fonte théières	163
Food box	209
Forgé couverts	228
Forgé poêles	190
Forté Vina	14
Fortuna coupe	158
Forum Arcoroc	65
Fouets	262
Fourch servir inox	262
Fourchette découper	260
Fourchettes escargot	237
Fourchettes huître	237
Fournure fauteuil	279
Fraicheur bouteille	73
France Made in	177
Frigo pichet	77
Friteuse air chaud	216
Friteuse Colorama	217
Friteuse Nord	197
Frosted Fluid	75
Fruits de Mer	237
Fuji fonte	163

Funky pivot	277
Fusil	260
Fusil Pro Classique	260
FW terrines	214

G

Galaxy pastas	143
Galéa	4
Galetière Colorama	189
Gant silicone	237
Gaspard chaise	276
Gastronomes bacs	202
Gatsby	51
Génération assiettes	152
Génération gobelets	71
Génoise couteau	260
Giara bouteilles	73
Gigogne gobelets	66
Gin gobelets liqueur	161
Gin Tonic SPKSY	52
Gin Tonic Timeless	40
Gina chaise	274
Ginette fauteuil	274
Givré Finition	226
Glace Timeless	40
Glaçons cuillers	236
Glen Novastyl	48
Glitch The Tiki	60
Gloire Bonna	117
GN bacs couverts	263
GN bacs gastronomes	202
Goliath couteau steak	234
Gourmet Knidos	88
Gourmet passion	121
Gourmet Viento	117
GP Gin	161
Granity chopes Arcoroc	65
Granity mini	161
Graphite tisanière	165
Grappe V. Juliette	30
Gratin inox	253
Great Gastby	23
Grenada OGO	100
Grès Novastyl	129
Grès OGO	98
Grès Oli	96
Grès pichets	162
Grillades 2 rivets	235
Gris Vita	169
Gustave théières	164
Gustave tisanière	164

H

Habana Bormioli	67
Hachoir ail	248
Hachoir viande	248
Hampshire	53
Harena Stairo	151
Harmony Filla	233
Harry plats	196
Havane couverts	230
Havane jungle couverts	230
Hawai moulin poivre	239
Haworth Bock	55
Haydn Filla	233
Heat System Opal	148
Hel tasses porcelaine	168
Hemingway	23
Hera tasses	164
Heraclee	130
Hêtre dessous plat	251
Hôtels chopes	53
Home Equip vap	32
Hôpital assiettes	148
Hornfels Bonna	120
Hot Shot	161
Huître fourchette	237
Hurricane	33

I

Ica sets de table	259
Ice Barshine	67
Ice Blue chopes salto	70
Icon Onis chopes	53
Iconics jattes	207
ID FINE	104
Impérial Pasa	47
Impérial Séquence flûte	9
In alto gobelet	69
In Alto Tre Sensi	36
Fournure fauteuil	48
Inao Pasa	46
Infuseurs	166
Inox corbeilles	253
Inox Easy	184
Inox marmite	197
Inox moulin	239
Inox plats escargot	155
Inox Pro S	180
Inox Profi	265

Inox ramequins	253
Inox saladiers	154
Instinct couverts	226
Inverness chopes	53
Invitation mise en bouche	160
Iris amovible	184
Iris inox	184
Iris sets de table	258
Irish Coffee	54
Irresistible Pyrex	206
Islande chopes	72
Islande minis	161
Ivento Vap	15
Ivoire Vita	169
Ivory vap	47

J

Jacinthe d'eau sets table	258
Jade grès	131
Jade Primary	9
Jaipur grès	130
Jambon couteau	260
Japan carré porcelaine	139
Jardin salon	271
Jasmin	128
Jatte borosilicate	204
Jauge Grappe	11
Jauges verres	82
Jaune Kuwae	154
Jazz glaces	159
Jazzed coupe	159
Jean's Brush	149
Jet couverts	229
Jeunes Vins Cabernet	10
Joints Le Parfait	215
Jolly	54
Joy	44
Juliet	162
Juliet tisanière	162
Juliette Vina vap	30
Jumbo couteau	235
Jungle Havane couverts	230
Jute naturel sets table	259
Jute set de table	259

K

K porcelaine	103
Kaffe Gloire	117
Kalix vap	39
Karl Ambre	165
Katanga OGO	100
Kazub tasses porcelaine	168
Keygo	166
Kitchen Lab	264
Klip poubelle	266
Knidos	88
Krysta	7
Kuwae mélamine	154

L

Lachat Bonna	127
Lagoon Ocean	112
Lal vap	49
Lasagne Pyrex	207
Laska	164
Latino	55
Lav verres	49
Lavande boîtes	210
Lave pont	266
Le Parfait	213
L'Eau chope	69
Leaves sets de table	259
Leerdam Vap	52
Légumiers inox	154
Légumiers inox	253
Leia tasses	164
Léo moulin	240
Léopard	51
Levier tire-bouchon	257
Libbey Perception	52
Lima Arc chopes	10
Lima ménagères	227
Limonaadier	257
Linéal vap	35
Linz chopes	55
Lion soupère	155
Lodge incliné porcelaine	144
Log gobelets trempé	64
Lola	66
Lola Duralex	66
Longhamp chopes	31
Longhamp West Loop	31
Loop west chopes	31
Lotus coupelle	156
Louche inox	262
Louchebém couteau steak	235
Louches cuisine	262
Louches inox pro	262
Louis XV plateaux	253
Louis XV porcelaine	110

Louise.....	227
Lounge Barware.....	62
Lounge Rock Bar.....	67
LPS Color Vis.....	213
Lubiana porcelaine.....	142
Luca Mozaic.....	118
Luminarc feston.....	151
Luminarc Roman.....	32
Luna chopes.....	69
Luna sets de table.....	258
Lunar Ocean.....	119
Lybra chopes.....	69
Lyon gobelets.....	67
Lyonnais.....	76
Lys chopes Duralex.....	66

M

Machines sous vide.....	218
Magenta cuisson.....	188
Magnifique verre à pied.....	30
Maka porcelaine.....	126
Maléa chopes.....	70
Manche balai.....	266
Mandoline Deluxe.....	244
Manhattan Duralex.....	66
Manille couverts.....	224
Manivelle Auguste.....	166
Manivelle moulines.....	240
Manqué acier moules.....	199
Manqué moule.....	200
Manque Pyrex.....	207
Margarita.....	56
Marguerita.....	56
Marine Duralex.....	66
Marjolaine.....	156
Marmite.....	196
Marmite moule.....	197
Marmite Inox Pro.....	180
Marqueurs.....	215
Marriot porcelaine.....	146
Martele couteau steak.....	235
Martelé porcelaine.....	143
Martin Buffet.....	262
Martini.....	57
Martini Brio.....	57
Maryse Eliott.....	263
Masquerade Broadway.....	31
Masquerade ex Broadway.....	31
Matignon vap.....	48
Mazagan cuiller.....	236
Mélatine.....	154
Mélatine Rivage.....	154
Mellow.....	106
Melodia.....	27
Ménage.....	266
Ménage articles.....	266
Ménagères sel-poivre.....	242
Ménastyl accessoires.....	244
Ménastyl Batch Cooking.....	211
Ménastyl boîtes.....	211
Ménastyl Cerise.....	191
Ménastyl Colorama.....	188
Ménastyl cuisson.....	191
Ménastyl Cristal.....	208
Ménastyl Fonte.....	194
Ménastyl France.....	177
Ménastyl moulines.....	241
Ménastyl PEM.....	219
Menthe chopes.....	67
Meravigliosi.....	23
Métropole couverts.....	230
Metropolitan porcelaine.....	137
Michelangelo vap.....	18
Microdenté couteaux.....	234
Milano chopes.....	39
Milano New Kalix.....	39
Mint Barshine.....	67
Mister Chef saladiers.....	153
Misure carafes.....	76
Mixo Diamante.....	68
Mixology Elysia.....	43
Mixology Vap.....	19
Mixte cuiller croco.....	237
Modest ID Fine.....	111
Mojito verres.....	61
Moka valmy.....	236
Mokas cuillers.....	236
Mona théière.....	162
Mondial Vap.....	14
Mont Blanc couteau.....	235
Montauk salon.....	273
Monte-Carlo Vap.....	44
Monture inox bocal.....	213
Mop.....	265
Moule marmite.....	197
Moules acier carbone.....	201
Moules Acier TK.....	200
Moules cuisson.....	216
Moulin café.....	166
Moulines Coloré.....	241
Moulines poivre et sel.....	239
Moutardiers.....	242
Mozaic Luca.....	118
Mr Chef saladiers.....	153

Muffin moules.....	201
Mug paille.....	60
Mugi théière.....	164
Mugs grès blanc.....	169
Mugs Opal.....	151
Mugs verre.....	167
Mules Bormioli.....	60
Muscade moulines.....	240
Mylla.....	5

N

Nadia tasses porcelaine.....	168
Nagoya.....	50
Napoli.....	271
Narok Mise en bouche.....	160
Natura.....	127
Nature OGO.....	233
Naturel bois moulines.....	240
Néo vap.....	12
New Kalix chopes.....	69
New Martini cocktail.....	57
New York Arcoroc.....	64
Nexo vap Bormioli.....	36
Next empilable.....	61
Nice vap.....	49
Nick & Nora Bormioli.....	38
Nick & Nora Disco.....	9
Nick & Nora Mixology.....	19
Nick & Nora Timeless.....	40
Nick & Nora vap.....	52
Noa vap.....	49
Noir brosse WC.....	266
Noir cendriers.....	243
Noir chopes.....	9
Noir couteau steak.....	235
Noir First.....	187
Noir Florali.....	132
Noir ID Fine.....	109
Noir Opal.....	150
Noir porcelaine.....	111
Noisette moules.....	199
Nonik Arcoroc.....	65
Nonik.....	46
Nonix.....	39
Normandie Vap.....	34
Norvege Arcoroc.....	65
Note de musique.....	17
Nova Aquitania.....	148
Nova grès OGO.....	97
Novastyl Atome.....	122
Novastyl blanc porcelaine.....	136
Novastyl couleur.....	50
Novastyl couverts.....	227
Novastyl Grès.....	129
Novastyl grès.....	130
Novastyl Natura.....	127
Novecento chopes.....	62
Novecento cocktail.....	38
Now's Home mobilier.....	271
Nuance porcelaine.....	123
Nylon balai.....	266
Nylon louche.....	262

O

O Cuisine plats.....	204
Océan couverts.....	223
Océan Lagoon.....	112
Océan Lunar.....	119
Océanie OGO.....	231
Octave.....	198
Octave ramequin.....	157
Office bois.....	235
Office manche PP.....	261
Office polypro.....	261
OGO accessoires.....	257
OGO couverts.....	231
OGO émaux réactifs.....	95
OGO Omega.....	102
OGO porcelaine.....	90
OGO porcelaine.....	92
OGO pro inox poèles.....	180
OGO thé et café.....	164
OGO théières.....	164
OGO Tisanières.....	162
OGO Urus.....	90
OGO vaisselle.....	98
OGO vap.....	59
Olga couverts.....	223
Oli OGO.....	96
Olive cuisson.....	188
Omega.....	102
Onctuose.....	158
One The vap.....	15
Onis.....	53
Opal assiettes Restaurant.....	149
Opal tasses.....	149
Open Up Chopes.....	6
Open Up vap.....	6
Optica Speakeasy.....	73
Optima carafes.....	24
Optima condiments.....	242
Optiva.....	156

Or assiettes filet.....	140
Ora OGO.....	92
Orange brush.....	149
Oreille bol parisien.....	157
Oreilles rondelles.....	215
Organisateur évier.....	247
Oriente bouteille.....	74
Origin couteaux.....	260
Osaka théières.....	163
Oscar.....	266
Oscar théière.....	164
Oslo blanc porcelaine.....	147
Oslo bol.....	156
Oslo vap.....	13
Outline Arcoroc.....	70
Oval coupe.....	158
Oval Delta.....	105
Oval Knidos.....	88
Oval plats.....	156
Ovenchef Ramequin.....	157
Oxford.....	62
Oxygene Arcoroc.....	65

P

Pack terrines.....	214
Page balance.....	265
Pain assiettes carré porc.....	139
Palmerie.....	124
Palmier coupe.....	159
Paneled chopes.....	53
Panier cloche.....	258
Panier frites.....	154
Panier friteuse.....	197
Panier vapeur.....	207
Panières jonc.....	258
Papier moule friteuse.....	216
Paris moulines OGO.....	240
Paris sel & poivre.....	242
Noir Opal.....	157
Pasa empilable.....	61
Pasabahce.....	44
Pasabahce saladiers.....	153
Pasabahce Trempe.....	61
Passion gourmet.....	121
Passoire inox.....	253
Pasta Martelé.....	143
Pastas Galaxy.....	143
Pâtes assiettes porcelaine.....	136
Pâtes creuses.....	145
Patio salon.....	271
Pâtisserie Pyrex.....	207
Paula plateau.....	168
Paula tasses porcelaine.....	168
Peach Barshine.....	67
Peche chopes.....	67
Peint main assiettes.....	121
Pelle balayette.....	266
Pelle tarte.....	262
PEM Menastyl.....	219
Pentagon Onis.....	53
Pepite coupe à glace.....	158
Percolateur.....	218
Perforé bacs gastro.....	202
Perforé moules.....	201
Personnalisés verres.....	82
Personnes âgées assiettes.....	148
Pèse-personne.....	265
Picardie assiettes.....	152
Picardie Duralex.....	66
Pichets grès blanc.....	77
Pichets verre.....	77
Pierre Boral.....	99
Pince crustacés.....	237
Pince service.....	261
Pinces bacs GN.....	202
Pinces Buffet.....	262
Pinces escargot.....	155
Pinces glaçons.....	261
Pinces linges.....	267
Pineapple.....	60
Pinot chope Supremo.....	21
Pique bigorneaux.....	237
Pizza blanc porcelaine.....	136
Pizza couteau steak.....	235
Pizza couteaux.....	235
Pizza ID Fine.....	106
Pizza Viento.....	117
Planche pizza.....	250
Planches plastique.....	246
Planches Polypro.....	251
Plane aïle porcelaine.....	142
Plaque four acier.....	200
Plaque pizza acier.....	200
Plastique boîtes.....	246
Plastique sets table.....	259
Plat carré Octave.....	198
Plat gâteau porcelaine.....	144
Plat grille grès.....	198
Plat œuf blanc.....	156
Plat œuf mini.....	156
Plat ovale grès.....	198
Plat rond grès.....	198
Plat rôtir avec grilles.....	196
Plateau fruit de mer.....	237

Plateau inox.....	252
Plateaux mélamine.....	251
Plats acier.....	199
Plats Airfryers.....	205
Plats borosilicate.....	204
Plats creux inox.....	196
Plats escargot inox.....	155
Plats escargots.....	155
Plats feston opal.....	151
Plats gratin.....	156
Plats gratin inox.....	154
Plats gratin verre.....	204
Plats grès blanc.....	156
Plats ronds.....	156
Plats verre.....	152
Plats verre.....	152
Poèles alu.....	191
Poèles Alu Pro.....	186
Poèles frire émail.....	197
Poèles intérieur inox.....	180
Poèles Triply.....	177
Poignée mandoline.....	244
Poisson poêle.....	180
Polo porcelaine.....	138
Polyéthylène couvercle.....	209
Polypro planches.....	251
Polypropylène bacs.....	203
Pompe main.....	249
Pompe vin.....	256
Pony Nude.....	45
Porcelaine OGO.....	92
Porcelaine coupe blanche.....	137
Porcelaine ID Fine.....	104
Porcelaine Novastyl.....	128
Porcelaine Nuance.....	123
Porcelaine Omega.....	102
Porcelaine Palmerie.....	124
Porcelaine renforcée.....	147
Porcelaine sel & poivre.....	242
Porte filtre.....	166
Porte ustensile.....	247
Porte-couverts.....	263
Pot lait inox.....	252
Pot Lyonnais.....	76
Potage bol.....	151
Pots confitures.....	215
Pots inox.....	166
Poule coquetier.....	155
Presicio.....	264
Pressbox.....	210
Presses agrume.....	248
Presse ail.....	244
Presse citron verre.....	248
Primary chopes.....	9
Primary Color.....	9
Princesa Vap.....	35
Prisme Duralex.....	66
Pro Alu Menastyl.....	186
Pro inox cuisson.....	180
Pro Tasting.....	6
Professionnal Tre Sensi.....	36
Professionnel casseroles.....	180
Profi balance.....	265
Pulcinella.....	60
Pure chopes Schott Zwiesel.....	15
Pure Nude.....	45
Pure vap Belfesta.....	15
PVC sets table.....	259
Pyrex.....	206
Pyrex congélation.....	206
Pyrex doseurs.....	264
Pyrex O Cuisine.....	204

Q

Quadro brocs.....	77
Quadro coupe.....	159
Quattro Stagioni.....	60

R

Raclette embout.....	266
Radiant.....	53
Rafraîchisseur inox.....	252
Rafraîchisseur vin.....	256
Ramequin blancs.....	157
Ramequin Cafeteria porcelaine.....	147
Ramequin Canelle.....	157
Ramequin Duralex.....	157
Ramequin grès.....	157
Ramequin Lyon.....	67
Ramequin inox.....	157
Ramequins trempé.....	157
Range couverts.....	263
Râpe fromage.....	243
Ravier verre.....	157
Raviers Delta.....	105
Raviers grès blanc.....	156
Raviers Opal.....	151
Raviers Sarreguemines.....	147
Raviers verre.....	157
RCR.....	24
Réactif émail.....	126
Reckless.....	109

Rectangle Alaska	137
Rectangle Square	139
Rectangle Vago	120
Rectangles carpaccio	146
Recyclé aluminium	187
Recyclé moulines	240
Red Flash	191
Regal mise en bouche	160
Régence plats inox	253
Regethermie	148
Réhausses casier	263
Reims flûte	58
Restaurant Slim Opal	150
Restaurant Uni Opal	149
Resto uni couverts	222
Rétro Joy	44
Réverie carafe	78
Réverie Cognac	49
Revêtement céramique	187
Revêtu cuisson Inox	179
Rhin jambe verte	48
Rhum vap Cognac	54
Riga grès	167
Rita coupe inclinée	144
Rita Lodge saladiers	143
Rita Steak porcelaine	146
Rita tasses Bonna	89
Riva chaise	276
Rivage Mélamine	154
Rivera Bleu	50
Rivera Vert	50
Rivets couteaux steak	261
Riviera Orange	50
Riz bol porcelaine	156
Rock Bar coupe	158
Rock Bar gobelets	67
Rock Bar Mini	160
Rocks Tarq	53
Roissy couverts	236
Roma 1960 vap	21
Roma by Luigi Bormioli	21
Roma chopos	21
Roma GAPB	143
Roma vap by Onis	52
Roman vap	32
Rondelles bocaux	215
Rondo	48
Rose Colorama	188
Rose Faustine	133
Rouge Fonte	194
Rouge porcelaine	121
Rouge Salto chopos	70
Rouleaux film	249
Roulette pizza	245
Round Open Up	6
Royal Leerdam	52
Rubino vap	18

S

Sacs sous vide	249
Safran poêles	188
Sahara Tone	113
Saladier bois	251
Saladiers antidérapants	154
Saladiers Arcoroc	153
Saladiers inox	154
Saladiers Opal	151
Saladiers Restaurant	151
Saladiers verre	152
Salière bouchon inox	242
Salon jardin Calypso	272
Salon jardin Mautauk	273
Salon jardin Patio	271
Salto ice blue	70
Salto mini	161
Salto Rouge	70
Sand	48
Sangria cuillers	236
Santoku couteau	260
Santoku Artisan	260
Sarreguemines porcelaine	147
Satiné baguette	231
Saturne	95
Saucière Aronal	98
Saucière inox	252
Saucière Kaffe	117
Saupoudreuses	242
Sauteuse Inox	180
Sauteuse inox	185
Savage Nude	45
Savane	129
Savoie Vap Arcoroc	33
Sculptes verres	37
Seau	266
Seau glace inox	252
Seau inox	252
Seau isotherme	252
Seaux brasserie inox	252
Seb cocotte-minute	196
Séchoir tour	267
Sel poivre blanc	242
Sensa Zwiesel	17
Sensation Exalt	10
Sense steak	235

Sensus	17
Sentido Irish	54
Séquence vap	9
Serenity	61
Serpillère	266
Sets cuisson Easynox	183
Sets de table	258
Sets saladiers	209
Sets table PVC	259
Seychelles coupe	158
Shaker Barman	257
Sheland chopos	63
Shetland mini	161
Shooters	160
Shot Hot mise en bouche	161
Shots Boston	160
Siam set de table	258
Sigma porcelaine	93
Silhouette vap	33
Silicone accessoires	216
Silicone couvercles	196
Silicone louche	263
Silicone moules	201
Silk gobelets	69
Slim couverts	224
Slim Restaurant	150
Snack set	209
Snacking couverts	236
Snifer cognac bière	54
So Urban	209
Soda cuillers	236
Soft Open Up	6
Sole filet couteau	260
Son'hyx	18
Sorbet coupe	158
Soucoupes verre	167
Soufflé moules blancs	157
Soufflé Pyrex	207
Soupière TDL	155
Soupière tête de Lion	155
Sour Cocktail	60
Sous vide machine	249
Sous vide sacs	249
Space Gourmet	121
Space Vap	121
Spatule bois	263
Spatule silicone	263
Spatules Flex	261
Speakeasy	52
Speakeasy Swing	23
Speciality Opal Black	150
Sphérique coupe	159
Spirale	124
Spirales Viticole	82
Spirit Bar	54
SPKSY vap	52
Splendid Vina	32
Spring broc	77
Spritz Timeless	24
Square porcelaine	139
Square Top Class	68
Stack RCR	25
Stack Up chopos	63
Stack Up Cross	63
Stack Up mini	161
Stairo Arcoroc	151
Starline	63
Steak couteaux	234
Steak manche PP	234
Steak Opal	149
Stérilisateur Inox	212
Stérilisation bocaux	214
Stockholm chope Arc	72
Stockholm mini	161
Stone Barware	62
Studio couteaux	261
Sublym vap	7
Super Le Parfait	214
Support seuu champagne	252
Supremo vap	59
Surf gobelet	71
Sweet Cocktail	60
Swing bouteille	74
Swing Speakeasy	23
Swing Top Le Parfait	73
Symétrie flûtes	59
Symétrie vap	7

T

TA élégance	33
TA normandie	34
Table Bel Air	272
Table et fauteuil	272
Table métal	272
Table repasser	267
Tabouret bar	270
Tajine fonte	195
Tajine grès blanc	155
Tam Tam couverts	232
Tannic Open Up	6
Tapas bodéga	71
Tapas fourchette	222
Tapis caoutchouc	266
Tarq Onis	53
Tarte acier moules	199

Tarte moule Octave	198
Tarte plats	152
Tartineur couteau	236
Tasse Oslo	147
Tasses empil blanc	168
Tasses empilable porcelaine	168
Tasses Kaffe Bonna	117
Tasses Karl	165
Tasses Opal	151
Tasses verre	167
Taste vap	17
Tattoo	25
Tequila Backdoor 20s	23
Terracota Octave	198
Terrine Le Parfait	214
Terrines blanc	155
Terrines Le Parfait	214
Terrines rectangles grès	155
Terrines Wiss	214
Tête balai nylon	266
Tête de Lion soupière	155
Thé infuseurs	166
The One vap	15
Théière verre	164
Thermomètre	256
Thera porcelaine	103
Thermic Glass	167
Thermomètres	264
Tiffany	110
Tiki	60
Tiki Sardinia	60
Tiki Split	60
Timeless Pasabahce	40
Timeless RCR	24
Tire bouchon	254
Tire rondelles	215
Tirettes homard	237
Tisannières	162
Tisannières verre	165
Tissage set table	259
Tissé sets de table	258
TK moules	201
Top Class chopos	68
Top of stove	182
Toqueur œufs	243
Toros	71
Tourtière Octave	198
Tower	46
Tower Novastyle	49
Tradition couteau steak	234
Tradition vieux Paris	225
Tranche-lard	260
Trappeur couteau	235
Tre Sensi Inalto	36
Trempe Bormioli	39
Trempé verres	61
Triangle spatule	261
Trinox	178
Trinox revêtu	179
Triply Inox	177
Trudeau moulines	241
Tube chope islande	72
Tube Timeless	41
Tulip bière vap	49
Tulip Cabernet	11
Tulip vap Pasa	44

U

U porcelaine	102
Ulysse	278
Uni Couzon plateaux	253
Universal Open Up	6
Universelles rondelles	215
Uno In Alto	36
Urban So Arcoroc	209
Urus by Ogo	90

V

V. Juliette	30
Valmy couverts	222
Vases	243
Vasque champagne	252
Vega lumignon	161
Venezia	27
Venus porcelaine	94
Verre assiettes	152
Verre mesure	264
Verre saladiers	153
Verres bière	55
Verres doseur	264
Verrines bocaux	214
Versailles	167
Verser pots inox	166
Vert brush	149
Vert cocotte fonte	194
Vert Heraclée	130
Vert Octave	198
Verte filet	111
Verte Natura	127
Vésuve moka	236
Vide poche blanc	243
Viento Bonna	117

Vieux Paris BG couverts	225
Vieux Paris satiné couverts	225
Vieux Paris tradition	225
Viggo théières OGO	163
Vigne chopos	8
Vigne mise en bouche	161
Viktor	78
Village carafes	73
Vin au Verre	82
Vina chopos Arcoroc	70
Vina chopos Juliette	70
Vina Juliette	30
Vina piscine	32
Vina Schott Zwiesel	14
Vina vap Arcoroc	32
Vinciana vases	243
Vins Jeunes Carbernet	10
Vintage Arès	231
Vinyl sets de table	259
Vira coupelles verre	159
Virgule steak	234
Vis tire bouchon	254
Vita ivoire	169
Viticole vap	32
Vitrified Bonna	88
Vodka West Loop	31
Volcano Novastyl	95
Volcano steak	235
Voluta	167
Vulcano	267

W

Warm Open Up	6
Wassingue	266
Weizenbier	54
Wells	55
Wersal porcelaine	142
Wersal tasse porcelaine	168
Wersal théières	162
West Loop	31
Whisky Top Class	68
White Opal blanc	150
White porcelaine	136
White saladiers porcelaine	136
Willi becher	70
Winchester chopos	53
Wok poêle inox	177
Wok Triply	177
Wood planches	250

X

Xtratuff	52
XXL Cognac	54

Y

Yack fauteuil	279
Ycarea infuseur tube	166
Ypsilon carafes	76
Ypsilon chopos	63
Ypsilon cocktail	57
Ypsilon coupe glace	158

Z

Zenith Ogo	12
Zwiesel	14
Zwiesel Taste	17

Code.....Page

0

0212001.....	218
0212002.....	218
0212003.....	218
0212005.....	218
0661098.....	265
0861505.....	265
0861506.....	265
0861507.....	265
0861509.....	265
0861515.....	265
0861516.....	265

1

1029100.....	257
1029831.....	32
1210112.....	215
1210185.....	215
1210189.....	215
1210190.....	215
1210191.....	215
1210193.....	215
1310018.....	167
1310155.....	264
1310205.....	157
1310570.....	153
1310572.....	153
1310573.....	153
1310574.....	153
1310575.....	153
1310576.....	153
1310577.....	153
1310638.....	66
1310640.....	66
1450010.....	206
1450011.....	206
1450012.....	206
1450013.....	206
1450014.....	206
1450015.....	206
1450016.....	206
1450017.....	206
1450032.....	207
1450033.....	207
1450035.....	207
1450036.....	207
1450040.....	208
1450074.....	205
1450076.....	205
1450082.....	207
1450094.....	205
1450096.....	205
1450098.....	205
1450116.....	207
1450117.....	264
1450118.....	207
1450119.....	264
1450121.....	264
1450123.....	264
1450124.....	264
1450125.....	264
1450126.....	264
1450127.....	264
1450140.....	205
1450141.....	205
1450142.....	205
1450143.....	205
1450144.....	205
1450151.....	207
1450152.....	207
1450153.....	207
1450155.....	207
1450156.....	207
1450157.....	207
1450158.....	207
1451004.....	206
1451005.....	206
1451006.....	206
1451007.....	206
1451018.....	206
1451022.....	206
1451023.....	206
1451024.....	206
1451025.....	206
1459003.....	204
1459004.....	204
1459005.....	204
1459009.....	204
1459018.....	205
1459039.....	204
1459040.....	204
1510006.....	214
1510007.....	214
1510008.....	214
1510009.....	214
1510010.....	214
1510011.....	214
1510024.....	214
1510025.....	214
1510026.....	214
1510027.....	214
1510028.....	214
1510029.....	214
1510052.....	215
1510060.....	215
1510061.....	215
1510062.....	215

1510064.....	215
1510070.....	215
1510071.....	215
1510072.....	215
1510096.....	215
1510145.....	214
1510146.....	214
1510147.....	214
1510148.....	214
1510149.....	214
1510150.....	214
1510151.....	214
1510230.....	73
1510231.....	215
1510235.....	73
1510236.....	215
1510240.....	215
1510241.....	215
1510242.....	215
1510245.....	247
1510248.....	215
1510250.....	215
1510258.....	215
1510259.....	215
1510290.....	249
1510291.....	249
1510292.....	249
1510315.....	213
1510316.....	213
1510317.....	213
1510318.....	213
1510319.....	213
1510324.....	213
1510325.....	212
1510326.....	212
1510328.....	248
1510329.....	248
1510332.....	248
1510341.....	248
1510345.....	249
1510346.....	249
1510348.....	249
1510361.....	213
1510365.....	213
1510370.....	213
1510372.....	213
1510376.....	213
1510385.....	249
1510386.....	249
1510387.....	249
1510388.....	249
1510389.....	249
1510390.....	249
1510391.....	249
1510392.....	249
1604140.....	66
1605028.....	60
1605029.....	60
1605080.....	60
1605085.....	264
1605091.....	77
1605092.....	78
1605093.....	78
1605105.....	243
1605383.....	55
1605435.....	50
1605436.....	50
1605437.....	50
1605438.....	50
1605440.....	50
1605441.....	50
1605442.....	50
1605443.....	50
1605445.....	50
1605446.....	50
1605447.....	50
1605448.....	50
1605450.....	51
1605451.....	51
1605452.....	51
1605455.....	51
1605456.....	51
1605457.....	51
1605458.....	51
1605460.....	51
1605461.....	51
1605462.....	51
1605463.....	51
1610135.....	77
1610136.....	77
1610137.....	77
1611465.....	160
1611480.....	49
1611493.....	167
1611582.....	40
1611634.....	78
1611635.....	78
1611720.....	73
1611721.....	73
1611722.....	73
1611878.....	153
1611879.....	153
1611880.....	153
1611881.....	153
1611882.....	153
1611883.....	153
1611884.....	153
1611889.....	209
1611965.....	71
1611970.....	71
1613027.....	47
1613041.....	47
1613060.....	44

1613061.....	44
1613062.....	44
1613063.....	44
1613064.....	58
1613065.....	44
1613081.....	43
1613082.....	43
1613083.....	57
1613084.....	160
1613085.....	43
1613086.....	43
1613087.....	43
1613088.....	43
1613110.....	61
1613111.....	61
1613112.....	61
1613113.....	61
1613114.....	61
1613140.....	61
1613186.....	40
1613188.....	40
1613189.....	40
1613191.....	40
1613192.....	40
1613193.....	40
1613214.....	160
1613215.....	41
1613216.....	40
1613217.....	41
1613218.....	41
1613223.....	41
1613224.....	40
1613225.....	41
1613226.....	41
1613227.....	41
1613228.....	41
1613235.....	152
1613242.....	71
1613243.....	152
1613244.....	152
1613280.....	152
1613281.....	152
1613282.....	152
1613310.....	49
1613378.....	44
1613379.....	44
1613380.....	44
1613381.....	44
1613382.....	57
1613383.....	44
1613425.....	49
1613430.....	49
1613440.....	78
1613504.....	157
1613630.....	47
1613860.....	243
1613862.....	243
1615300.....	68
1615301.....	68
1615500.....	167
1615501.....	167
1615502.....	167
1615510.....	167
1615513.....	167
1616130.....	77
1616131.....	77
1616132.....	77
1616139.....	243
1616155.....	76
1616156.....	76
1616157.....	76
1616648.....	76
1616649.....	76
1616650.....	76
1618040.....	160
1618062.....	160
1618070.....	48
1618083.....	160
1618084.....	160
1618098.....	50
1618152.....	48
1618250.....	73
1618251.....	73
1618257.....	49
1618290.....	48
1618291.....	48
1618307.....	159
1618308.....	159
1618317.....	159
1618318.....	159
1618319.....	55
1618331.....	48
1618332.....	69
1618333.....	48
1618334.....	71
1618371.....	49
1618375.....	49
1618377.....	49
1618396.....	49
1618397.....	54
1618496.....	71
1618497.....	71
1618595.....	47
1618596.....	47
1618597.....	47
1618610.....	61
1618611.....	61
1618612.....	61
1618826.....	152
1618832.....	49
1618833.....	49
1618834.....	49

1631105.....	76
1631106.....	76
1631107.....	76
1631115.....	54
1641030.....	76
1641031.....	76
1660004.....	151
1664001.....	74
1690025.....	208
1692036.....	208
1692037.....	208
1692038.....	208
1946025.....	60
1946026.....	27
1946027.....	25
1946028.....	25
1946032.....	60
1946033.....	27
1946185.....	26
1946186.....	26
1946187.....	26
1946188.....	26
1946213.....	26
1946214.....	26
1946215.....	26
1946216.....	26
1946217.....	26
1946245.....	27
1946246.....	27
1946247.....	27
1946248.....	27
1946249.....	27
1946250.....	27
1946259.....	24
1946260.....	24
1946261.....	24
1946262.....	24
1946263.....	24
1946264.....	24
1946270.....	24
1946271.....	24
1946272.....	24
1946273.....	24
1946365.....	25
1946371.....	25
1946372.....	25
1946373.....	25
1946375.....	25
1971747.....	15
1971748.....	15
1971815.....	48
1971816.....	48
1971817.....	48
1971885.....	48
1971890.....	48

2

2425740.....	155
2513085.....	132
2513086.....	132
2513087.....	132
2513130.....	133
2513131.....	133
2513132.....	133
2513160.....	133
2513161.....	133
2513162.....	133
2513395.....	134
2513396.....	134
2513397.....	134
2513398.....	134
2513400.....	134
2513401.....	134
2513450.....	135
2513451.....	135
2513452.....	135
2513453.....	135
2513454.....	135
2513455.....	135
2513456.....	135
2513465.....	124
2513466.....	124
2513467.....	124
2513470.....	122
2513471.....	122
2513472.....	122
2514145.....	104
2514146.....	104
2514147.....	104
2514148.....	104
2514149.....	104
2514150.....	104
2514151.....	104
2514152.....	104
2514153.....	104
2514156.....	104
2514157.....	104
2514158.....	105
2514159.....	105
2514160.....	105
2514162.....	104
2514165.....	105
2514166.....	105
2514167.....	105
2514168.....	105
2514171.....	105
2514172.....	105
2514173.....	105
2514174.....	105
2514175.....	105
2514176.....	105

2514185.....	105
2514186.....	105
2514187.....	105
2514188.....	105
2514191.....	105
2514195.....	105
2514201.....	104
2514202.....	104
2514203.....	104
2514217.....	106
2514219.....	106
2514222.....	106
2514223.....	106
2514225.....	106
2514228.....	106
2514229.....	106
2514230.....	106
2514231.....	106
2514241.....	106
2514243.....	106
2514246.....	106
2514252.....	106
2514271.....	106
2514281.....	106
2514282.....	106
2514288.....	106
2514289.....	106
2514331.....	111
251	

2632485	121	2633326	115	2695055	147	3205897	131	4610459	202	4710132	260
2632487	121	2633327	115	2695056	147	3205898	131	4610464	202	4710134	260
2632508	121	2633328	115	2695057	147	3205925	129	4610465	202	4710135	260
2632509	121	2633329	89	2695062	147	3205926	129	4610466	202	4710136	260
2632571	121	2633334	89	2695063	147	3205927	129	4610467	202	4710139	234
2632574	121	2633335	89	2695069	147	3235135	130	4610468	202	4710220	223
2632575	121	2633337	88	2695070	147	3235136	130	4610470	202	4710221	223
2632576	121	2633338	88	2695071	147	3235137	130	4610473	202	4710222	223
2632578	121	2633339	88	2695086	147	3235138	130	4610474	202	4710223	223
2632579	121	2633400	88	2695087	147	3235139	130	4610476	202	4710225	223
2632582	121	2633401	88	2940002	155	3356052	157	4610477	202	4710226	223
2632583	121	2633402	88	2940003	157	3356060	156	4610478	202	4710242	235
2632586	121	2633403	88	2940004	157	3356125	198	4610479	202	4710248	222
2632587	121	2633404	88	2940005	157	3356126	198	4610480	202	4710260	235
2632648	114	2633405	89	2940006	157	3356127	198	4610481	202	4710263	261
2632649	114	2633406	89	2940007	156	3356130	198	4610482	202	4710264	234
2632650	114	2633407	89	2940018	156	3356131	198	4610483	202	4710287	235
2632651	114	2633409	88	2940025	156	3356132	198	4610489	202	4710385	225
2632652	114	2633410	88	2940026	155	3356135	198	4610490	202	4710386	225
2632653	114	2633411	88	2940027	155	3356136	198	4610492	202	4710387	225
2632654	114	2633413	89	2940029	155	3356137	198	4610510	261	4710388	225
2632655	114	2633414	89	2940031	156	3356140	198	4610550	203	4710389	225
2632658	114	26333524	88	2940032	156	3356141	198	4610551	203	4710391	225
2632659	114	26333525	88	2940034	155	3356142	198	4610552	203	4710402	253
2632665	114	26333526	88	2940035	156	3356145	157	4610553	203	4710403	253
2632689	118	26333528	88	2940038	156	3356146	157	4610554	203	4710404	253
2632690	118	26333529	88	2940039	156	3356147	157	4610555	203	4710410	235
2632691	118	26333530	88	2940044	156	3356150	157	4610556	203	4710415	253
2632692	118	26333533	89	2940045	156	3356151	157	4610558	203	4710426	253
2632695	118	26333534	89	2940048	156	3356152	157	4610559	203	4710428	253
2632698	118	26333537	89	2940054	157	3356155	198	4610561	203	4710429	253
2632736	120	26333538	89	2940056	242	3356156	198	4610562	203	4710430	253
2632737	120	2633541	88	2940057	242	3356157	198	4610564	203	4710431	253
2632749	117	2633577	91	2940063	243	3356161	198	4610565	203	4710432	253
2632750	117	2633578	91	2940064	243	3356162	198	4610566	203	4710441	262
2632751	117	2633585	91	2940065	156	3356165	198	4610567	203	4710443	262
2632765	117	2633593	91	2940066	156	3356166	198	4610568	203	4710445	237
2632766	117	2633596	91	2940073	155	3356167	198	4610569	203	4710446	237
2632822	156	2633598	91	2940074	155	3356170	198	4610570	203	4710448	155
2632823	156	2633603	91	2940077	157	3356171	198	4610571	203	4710449	237
2632824	156	2634010	127	2940079	156	3356172	198	4610572	203	4710450	237
2632826	117	2634011	127	2940087	157	3356180	198	4610573	203	4710451	237
2632827	117	2634012	127	2940096	155	3356181	198	4610574	203	4710452	237
2632828	117	2634013	127	2940105	155	3356182	198	4610575	203	4710453	155
2632830	117	2634015	127	2940110	168	3356185	198	4610675	260	4710454	237
2632831	117	2634016	127	2940111	168	3356186	198	4610690	260	4710455	262
2632832	117	2634017	127	2940114	168	3356187	198	4610691	260	4710457	237
2632834	117	2634018	127	2940115	168	3356220	157	4610701	260	4710458	237
2632835	117	2634019	127	2940117	169	3645025	197	4610717	260	4710472	236
2632836	117	2645506	146	2940119	169	3645561	197	4610718	261	4710491	225
2632837	117	2645519	144	2940240	156	3645562	197	4610719	260	4710492	225
2632838	117	2645542	144	2940241	156	3645563	197	4610828	218	4710493	225
2632840	117	2645559	146	2940242	156	3645564	197	4610830	218	4710498	225
2632841	117	2645560	146	2940245	156	3645567	197	4610835	218	4710589	157
2632842	117	2645561	146	2940246	156	3645575	197	4610868	218	4710590	253
2632886	117	2647616	156	2940247	156	3645579	197	4611863	251	4710591	157
2632887	117	2690340	143	2940301	156	3645580	197	4611910	261	4710592	253
2632889	117	2690341	143	2940330	168	3645749	197	4612030	264	4710631	235
2632898	251	2690342	143	2940331	168	3721270	154	4615191	243	4710711	237
2632899	251	2690343	143	2940332	168			4615192	243	4710712	234
2632900	251	2690346	143	2940333	168			4615200	253	4710713	237
2632901	251	2691060	168	2940432	77			4615202	243	4710771	236
2632944	112	2691061	168	2940433	77			4615204	155	4710811	236
2632948	120	2691062	168	2940434	162			4615205	155	4710820	232
2632949	120	2691063	168	2940436	77			4615220	196	4710821	232
2632950	120	2691064	168	2940455	155			4615221	196	4710822	232
2632951	120	2691065	168	2940460	155			4615222	196	4710823	232
2632952	120	2691066	168					4615226	252	4710824	232
2632953	120	2691067	168					4615295	154	4710825	232
2632954	120	2691068	168					4615296	253	4710826	232
2632955	120	2691074	162					4615297	154	4710827	232
2632956	120	2691208	142					4615298	253	4710860	229
2632957	120	2691209	142					4615305	252	4710861	229
2632958	120	2691211	142					4615306	252	4710862	229
2632959	120	2691212	142					4615307	252	4710863	229
2632960	120	2691213	142					4615308	252	4710880	264
2633102	116	2691214	168					4615309	252	4710894	236
2633103	116	2691215	168					4615312	243	4710896	236
2633104	116	2691216	168					4615313	243	4710897	236
2633106	116	2691217	168					4615326	252	4710914	236
2633109	116	2691259	142					4615332	253	4710932	232
2633110	116	2691260	142					4615340	154	4710933	232
2633123	113	2691261	142					4615341	154	4710934	232
2633124	113	2691262	142					4615342	154	4710935	232
2633128	113	2691263	142					4615344	253	4710936	232
2633130	113	2691270	168					4615345	154	4710937	234
2633250	117	2691271	168					4615346	253	4710938	232
2633251	117	2691275	162					4615347	252	4710939	232
2633252	117	2691306	144					4615348	252	4710970	224
2633253	117	2691309	143					4615349	252	4710971	224
2633263	117	2691310	143					4615450	196	4710972	224
2633264	117	2691312	144					4615451	196	4710973	224
2633265	117	2691330	242					4615452	196	4710978	236
2633266	117	2691331	242					4615453	252	4710979	236
2633269	117	2691410	168					4615455	196	4710980	224
2633300	112	2691411	168					4710001	223	4711359	236
2633301	112	2691415	168					4710002	223	4711810	232
2633302	112	2691416	168					4710003	223	4711811	232
2633303	112	2691420	168					4710004	223	4711812	232
2633305	113	2691490	143					4710020	262	4711813	232
2633306	113	2695001	147					4710039	236	4711814	234
2633307	113	2695002	147					4710088	223	4711815	232
2633309	113	2695003	147					4710089	236	4711816	232
2633310	113	2695004	147					4710090	236	4711817	232
2633312	113	2695005	147					4710091	236	4711819	232
2633318	115	2695007	147					4710092	223	4711820	232
2633319	115	2695014	147					4710093	223	4711821	232
2633320	115	2695015	147								

4712016	233	4735452	230	4835990	236	5040978	250	6020745	200	6021074	199
4712017	233	4735453	230			5040984	250	6020746	201	6021075	199
4712018	233	4735454	230			5040986	250	6020747	201	6021100	186
4712019	233	4735456	230			5040987	250	6020748	201	6021101	186
4712020	233	4735530	228			5041021	257	6020749	200	6021102	186
4712023	233	4735531	228			5041043	264	6020751	201	6021103	186
4712024	236	4735532	228			5041046	166	6020752	200	6021104	186
4712025	236	4735533	228			5025982	235	6020753	201	6021990	196
4712026	236	4735534	228			5025987	261	6020754	201	6021991	196
4712027	233	4735535	228			5039038	209	6020755	200	6021992	196
4712035	234	4735536	228			5039040	209	6020756	201	6025001	217
4712036	229	4735541	222			5039075	242	6020757	200	6025002	217
4712037	229	4735542	222			5039080	210	6020758	200	6025003	217
4712038	229	4735543	222			5039081	210	6020761	200	6025004	217
4712039	229	4735544	222			5039082	210	6020773	201	6025006	217
4712040	229	4735570	229			5039083	210	6020774	201	6025007	217
4712043	229	4735571	229			5039084	210	6020783	199	6025025	216
4712044	229	4735572	229			5039085	210	6020784	199	6025050	219
4712045	236	4735573	234			5039086	210	6020785	199	6025051	219
4712046	236	4735574	229			5039087	210	6020786	199	6025052	219
4712047	236	4735575	229			5039088	210	6020787	199	6025055	219
4712060	234	4735576	229			5039089	210	6020788	199	6211016	265
4712061	233	4735578	226			5040025	242	6020789	199	6317045	258
4712062	233	4735579	226			5040027	242	6020800	188	6317046	258
4712063	233	4735580	226			5040090	247	6020801	188	6317047	258
4712064	233	4735581	226			5040091	247	6020802	188	6317055	259
4712065	233	4735588	260			5040094	247	6020803	188	6317072	259
4712066	236	4735589	260			5040096	247	6020804	188	6317076	259
4712067	236	4735590	260			5040099	247	6020805	188	6317077	259
4712070	234	4735591	260			5040103	216	6020806	189	6317078	259
4712071	231	4735614	231			5040104	237	6020807	189	6317095	259
4712072	231	4735662	226			5040137	247	6020808	188	6317096	259
4712073	231	4735663	226			5040138	247	6020809	188	6317097	259
4712074	231	4735664	226			5040139	247	6020810	189	6317105	259
4712075	231	4735665	226			5040180	263	6020811	189	6317106	259
4712076	231	4735666	234			5040181	263	6020815	188	6317107	259
4712077	231	4735667	226			5040182	263	6020816	188	6317140	258
4712078	231	4735668	226			5040183	263	6020817	188	6317147	259
4712079	231	4735669	226			5040184	263	6020818	188	6317148	259
4712080	236	4735670	226			5040185	263	6020819	188	6317149	259
4712081	236	4735676	226			5040186	263	6020820	188	6317275	251
4712082	236	4735677	226			5040187	263	6020038	190	6317276	251
4712085	231	4735678	226			5040188	263	6020039	190	6317277	251
4712086	231	4735679	226			5040189	263	6020040	190	6317278	251
4712087	231	4735680	226			5040235	244	6020041	195	6317279	251
4712088	231	4735681	226			5040236	245	6020042	195	6317280	251
4725008	235	4735682	226			5040237	245	6020046	195	6317281	251
4725009	235	4735751	235			5040238	244	6020047	195	6317282	251
4725275	227	4735753	234			5040239	244	6020063	190	6317283	251
4725297	227	4735820	236			5040240	244	6020064	190	6317284	251
4725330	227	4735822	235			5040241	245	6020065	190	6317575	258
4725331	227	4735823	235			5040242	245	6020080	194	6317576	258
4725332	227	4735828	235			5040243	244	6020101	194	6317577	258
4725333	227	4735832	234			5040244	245	6020102	194	6317590	258
4725339	227	4735836	235			5040245	244	6020103	194	6317591	258
4725344	227	4737010	166			5040246	244	6020105	194	6317592	258
4725349	227	4737011	166			5040248	248	6020145	178	6317595	258
4725380	227	4737012	166			5040249	248	6020146	178	6317596	258
4725381	227	4737020	252			5040253	246	6020147	178	6317597	258
4725382	227	4737035	262			5040254	246	6020148	178	6317598	258
4725383	227	4737036	262			5040255	242	6020149	178	6317705	154
4725384	227	4737037	262			5040256	242	6020151	178	6317706	154
4735007	235	4737038	262			5040257	242	6020152	178	6317707	154
4735009	235	4737039	262			5040258	242	6020240	185	6317710	259
4735013	234	4737040	262			5040259	242	6020241	185	6317740	259
4735016	261	4737041	262			5040262	242	6020242	185	6317799	154
4735017	261	4737042	262			5040265	248	6020243	185	6317800	154
4735018	234	4737043	262			5040266	248	6020244	185	6317803	154
4735019	235	4737045	262			5040268	248	6020246	185	6317806	154
4735022	261	4737047	262			5040397	246	6020247	185	6317835	154
4735023	236	4737100	253			5040400	246	6020248	185	6317837	154
4735026	235	4737101	253			5040452	243	6020252	185	6340642	266
4735040	228	4737111	154			5040465	246	6020255	185	6340644	266
4735041	228	4737112	154			5040466	248	6020256	185	6340645	266
4735042	228	4737114	154			5040467	246	6020260	180	6340646	266
4735043	234	4737121	154			5040468	246	6020360	197	6340652	263
4735045	228	4737122	154			5040485	211	6020485	177	6340653	263
4735046	228	4737124	154			5040486	211	6020486	177	6340657	266
4735047	228	4737130	253			5040487	211	6020487	177	6340658	266
4735050	231	4737131	253			5040488	211	6020488	177	6340659	266
4735051	231	4738125	230			5040489	211	6020489	177	6340660	266
4735052	231	4738126	230			5040490	211	6020490	177	6340662	266
4735053	231	4738127	230			5040491	211	6020491	177	6340665	266
4735060	231	4738128	230			5040492	211	6020492	177	6340666	266
4735094	261	4738131	230			5040493	211	6020518	177	6340670	266
4735110	222	4738132	230			5040494	211	6020519	177	6340673	266
4735111	222	4738133	230			5040503	211	6020529	177	6341989	267
4735112	222	4738134	230			5040521	246	6020534	177	6341995	247
4735113	222	4740095	236			5040522	246	6020570	191	6515008	266
4735174	235	4740098	234			5040523	246	6020571	191	6515031	262
4735180	230	4740124	260			5040539	261	6020572	191	6515032	262
4735181	230	4740151	236			5040541	262	6020573	191	6515033	262
4735182	230	4740152	224			5040542	262	6020574	191	6515034	262
4735183	230	4740153	224			5040543	262	6020575	191	6515038	266
4735185	230	4740154	224			5040575	246	6020576	191	6515061	266
4735186	230	4740155	224			5040577	246	6020577	191	6515062	266
4735261	261	4740156	224			5040578	246	6020578	191	6515088	248
4735262	261	4835028	235			5040589	248	6020579	191	6515090	266
4735263	261	4835680	242			5040960	250	6020580	191	6515093	266
4735264	261	4835681	242			5040961	250	6020581	191	6515105	266
4735265	261	4835682	242			5040962	250	6020611	187	6515111	266
4735266	261	4835718	235			5040963	250	6020612	187	6515112	266
4735268	261	4835743	242			5040964	250	6020613	187	6515128	266
4735269	261	4835980	222			5040965	250	6020635	187	6515165	251
4735370	224	4835981	222			5040966	250	6020636	187	6515167	251
4735371	224	4835982	222			5040967	250	6020637	187	6515181	266
4735372	224	4835983	222			5040968	251	6020638	187	6515183	266
4735373	224	4835984	222			5040969	251	6020639	187	6515184	266
4735380	226	4835985	222			5040971	250	6020646	187	6515187	266
4735381	2										

6515318	266	7506148	8	7507510	63	7510946	35	7516009	157	7534106	69
6515322	266	7506150	8	7507511	63	7510947	35	7516010	153	7534107	38
6515324	267	7506151	8	7507512	63	7510948	35	7516011	153	7534161	62
6515326	267	7506152	8	7507513	63	7510961	30	7516012	153	7534162	62
6515438	267	7506153	8	7507514	63	7510962	30	7516013	153	7534163	62
6515443	267	7506225	70	7507515	63	7511002	54	7516014	153	7534200	39
6515454	263	7506238	10	7508008	55	7511003	54	7516015	153	7534201	39
6515455	263	7506239	10	7508009	55	7511005	54	7516016	153	7534204	39
		7506240	10	7508010	55	7511024	32	7516017	153	7534205	39
		7506242	10	7508011	55	7511028	32	7516018	153	7534206	69
		7506283	70	7508027	55	7511029	32	7516019	153	7534208	39
		7506310	54	7508100	55	7511082	82	7516020	153	7534283	37
		7506400	70	7510012	32	7511188	9	7516066	153	7534286	37
		7506401	70	7510013	32	7511213	31	7516068	153	7534287	37
		7506420	54	7510028	32	7511228	55	7516070	153	7534288	37
		7506422	6	7510031	32	7511229	55	7516072	153	7534289	37
		7506423	6	7510032	32	7511230	55	7516218	209	7534290	37
		7506430	30	7510033	32	7511231	55	7516219	209	7534293	37
		7506432	70	7510034	32	7511258	33	7516231	209	7534320	71
		7506476	31	7510035	33	7511260	33	7516233	209	7534330	73
		7506477	31	7510036	33	7511262	33	7516235	209	7534337	73
		7506482	70	7510037	33	7511263	33	7516236	209	7534340	74
		7506483	70	7510040	33	7511264	33	7516243	209	7534341	74
		7506488	72	7510043	32	7511266	33	7516245	158	7534342	74
		7506489	72	7510059	33	7511267	58	7516249	158	7534343	74
		7506490	72	7510065	33	7511269	33	7516250	158	7534382	38
		7506493	161	7510074	56	7511270	33	7516256	209	7534383	38
		7506494	72	7510312	11	7511280	8	7516257	209	7534384	38
		7506495	72	7510313	30	7511281	8	7516329	157	7534386	38
		7506496	72	7510314	82	7511282	8	7516330	248	7534387	38
		7506497	72	7510346	57	7511283	59	7516345	264	7534388	76
		7506498	72	7510347	57	7511290	7	7516380	161	7534389	38
		7506499	72	7510355	30	7511291	7	7520001	180	7534400	36
		7506500	72	7510356	30	7511292	7	7520002	180	7534401	36
		7506501	72	7510357	30	7511293	7	7520003	180	7534402	36
		7506502	72	7510358	30	7511294	7	7520004	180	7534404	36
		7506510	29	7510380	32	7511295	59	7520005	180	7534406	36
		7506511	29	7510381	32	7511296	7	7520016	180	7534420	69
		7506512	29	7510403	82	7511315	9	7520038	180	7534430	36
		7507020	65	7510410	59	7511316	9	7520060	180	7534433	36
		7507021	65	7510411	59	7511317	9	7520061	180	7534437	38
		7507022	65	7510413	57	7511318	59	7520062	180	7534438	38
		7507068	72	7510415	11	7511325	33	7520063	180	7534457	36
		7507075	65	7510416	11	7511326	33	7520065	180	7534462	69
		7507076	65	7510417	11	7511327	33	7520018	67	7534480	36
		7507077	65	7510418	11	7511328	33	7520019	67	7534481	36
		7507079	65	7510420	11	7511329	33	7520020	66	7534482	36
		7507082	65	7510421	11	7511335	8	7520025	160	7534491	54
		7507083	65	7510422	11	7511336	8	7520026	66	7534500	62
		7507084	65	7510423	11	7511337	8	7520027	66	7534501	62
		7507085	65	7510424	11	7511338	8	7520050	66	7534502	160
		7507087	65	7510437	56	7511345	29	7520051	66	7534510	67
		7507088	65	7510440	11	7511346	9	7520052	67	7534511	67
		7507089	65	7510445	10	7511347	56	7520053	67	7534512	67
		7507092	65	7510446	10	7511353	5	7520058	67	7534519	67
		7507093	161	7510447	10	7511354	5	7520060	160	7534522	67
		7507094	65	7510500	34	7511355	5	7520061	66	7534524	67
		7507147	34	7510501	34	7511356	5	7520063	66	7534532	160
		7507152	65	7510504	34	7511362	4	7520064	66	7534590	67
		7507154	158	7510535	34	7511363	4	7520068	66	7534594	67
		7507161	9	7510536	34	7511364	4	7520070	67	7534598	67
		7507162	9	7510537	34	7511365	4	7520072	160	7534612	39
		7507163	9	7510550	54	7511500	54	7520073	66	7534613	39
		7507239	161	7510605	35	7511510	31	7520074	66	7534614	39
		7507240	63	7510606	35	7511511	31	7520081	67	7534615	39
		7507241	63	7510607	35	7511512	31	7520085	67	7534621	39
		7507242	63	7510610	35	7511513	31	7520086	67	7534622	39
		7507243	63	7510614	34	7512009	158	7520087	67	7534623	67
		7507244	63	7510615	34	7512010	158	7525130	66	7534635	36
		7507245	63	7510617	34	7512045	158	7525132	66	7534636	36
		7507246	63	7510620	55	7512055	159	7525134	66	7534641	37
		7507290	63	7510621	55	7512070	159	7525220	66	7534643	37
		7507303	31	7510669	10	7512071	159	7526008	66	7534644	37
		7507304	31	7510670	10	7512080	159	7526009	66	7534645	37
		7507306	31	7510671	10	7512082	159	7526105	66	7534646	37
		7507328	31	7510672	10	7512097	158	7527035	157	7534663	38
		7507329	31	7510673	59	7512128	159	7527037	157	7534664	55
		7507330	64	7510701	33	7512129	159	7528001	152	7534665	38
		7507331	64	7510702	33	7512145	159	7528004	152	7534670	37
		7507332	64	7510750	35	7512153	54	7528080	66	7534671	37
		7507338	161	7510751	35	7512154	159	7528081	66	7534672	37
		7507340	64	7510752	35	7512160	159	7528082	66	7534851	60
		7321528	163	7510800	34	7513025	242	7528099	157	7534852	60
		7321629	163	7510801	34	7514201	243	7528115	157	7534853	60
		7505004	72	7510804	34	7514203	243	7528120	157	7534854	60
		7505006	161	7510806	32	7515001	77	7528121	157	7534855	60
		7505010	72	7510813	31	7515002	77	7528125	67	7534856	60
		7505020	161	7510814	31	7515003	77	7528200	152	7534860	62
		7505024	161	7510825	8	7515019	77	7528201	152	7534861	62
		7505027	72	7510826	59	7515020	77	7529070	39	7534862	62
		7505037	161	7510829	32	7515077	78	7529071	39	7534863	62
		7505065	161	7510830	32	7515085	77	7530005	72	7534864	62
		7505066	161	7510831	32	7515086	77	7530006	160	7534865	62
		7506017	54	7510865	59	7515087	77	7530007	160	7535130	158
		7506032	32	7510866	9	7515100	75	7530032	39	7535186	158
		7506033	70	7510867	9	7515101	75	7530033	39	7535238	158
		7506068	161	7510868	9	7515102	75	7530035	160	7535240	158
		7506069	161	7510892	58	7515110	75	7530090	69	7535244	158
		7506070	63	7510900	57	7515111	75	7530091	69	7536009	18
		7506071	63	7510901	57	7515112	75	7530092	69	7536010	18
		7506072	63	7510902	57	7515286	65	7531015	60	7536011	18
		7506073	63	7510910	7	7515287	161	7531022	242	7536014	59
		7506074	63	7510911	7	7515288	161	7534004	69	7536015	56
		7506085	70	7510912	7	7515290	75	7534039	160	7536041	18
		7506086	70	7510913	7	7515291	75	7534040	160	7536042	18
		7506108	161	7510914	59	7515292	75	7534079	71	7536105	58
		7506110	70	7510920	6	7515296	75	7534084	57	7536125	18
		7506111	70	7510926	6	7515299	75	7534085	63	7536127	19
		7506114	70	7510929	6	7515310	78	7534086	63	7536247	19
		7506115	70	7510932	6	7515325	75	7534087	63	7536248	57
		7506134	55	7510938	6	7515326	75	7534088	63	7536249	19
		7506146	161	7510941	6	7515327	75	7534094	158	7536250	19

7536251	19	7541448	204	7543404	15	7550887	148	7912015	162	7932200	169
7536253	68	7541450	204	7543409	15	7550890	148	7912017	166	7932205	91
7536255	19	7541452	204	7543410	15	7550891	148	7912018	166	7932206	169
7536256	21	7541456	204	7543412	15	7550892	148	7912019	162	7932207	91
7536257	21	7541457	204	7543429	15	7550900	148	7912030	162	7932208	94
7536258	21	7541458	204	7543433	15	7550901	148	7912032	162	7932209	94
7536259	21	7541460	204	7543437	15	7551225	149	7912034	162	7932210	94
7536260	57	7541462	204	7543470	14	7551226	149	7912045	162	7932211	94
7536261	21	7541465	205	7543471	14	7551227	149	7912047	166	7932212	94
7536262	21	7541466	205	7543472	14	7551228	149	7912048	166	7932213	94
7536263	21	7541469	205	7543474	14	7551230	149	7912050	164	7932214	94
7536264	59	7541470	204	7543475	14	7551231	149	7912052	78	7932215	94
7536265	19	7541472	204	7543477	14	7551232	149	7912053	78	7932216	94
7536266	19	7541473	204	7543479	14	7551233	149	7912055	166	7932217	94
7536267	19	7541479	82	7543481	14	7551234	149	7912060	166	7932218	94
7536268	19	7541552	43	7543487	14	7551235	149	7912099	164	7932219	94
7536269	19	7541553	43	7543490	17	7551236	149	7912102	164	7932240	98
7536287	23	7541554	43	7543491	17	7551237	149	7912103	164	7932242	98
7536288	23	7541555	43	7543492	17	7551238	149	7912104	164	7932243	169
7536289	23	7541573	45	7543493	17	7551239	149	7912107	162	7932244	98
7536290	23	7541574	45	7543496	17	7551240	149	7912106	164	7932252	99
7536291	23	7541579	45	7543549	17	7551241	149	7912165	162	7932253	169
7536292	23	7541580	45	7543551	17	7551242	149	7912166	162	7932254	99
7536342	74	7541581	45	7545930	150	7551243	149	7912167	162	7932255	97
7536343	242	7541583	45	7545931	150	7551244	149	7912168	162	7932256	97
7536380	74	7541587	45	7545932	150	7551245	149	7912169	162	7932257	97
7536381	74	7541588	45	7545933	150	7551246	149	7912170	162	7932258	97
7536385	74	7541589	45	7550002	149	7551247	149	7912171	162	7932259	97
7536392	74	7541592	45	7550003	149	7551248	149	7912175	163	7932263	100
7536393	74	7541593	45	7550004	149	7551250	149	7912176	163	7932264	100
7536394	242	7541595	45	7550005	149	7551251	149	7912177	163	7932295	95
7536395	74	7541615	46	7550008	149	7551252	149	7912178	163	7932296	95
7536406	167	7541616	46	7550010	149	7551254	149	7912179	163	7932297	95
7536407	167	7541618	46	7550013	149	7551255	149	7912180	163	7932298	95
7536408	167	7541619	46	7550023	151	7551256	149	7912181	163	7932299	95
7536431	76	7541630	46	7550025	149	7551257	149	7912182	163	7932300	95
7536432	76	7541631	46	7550026	149	7551258	149	7912183	163	7932305	103
7536440	74	7541632	46	7550027	149	7551352	167	7912184	163	7932306	103
7536441	74	7541859	57	7550028	149	7551353	167	7912185	165	7932307	103
7536458	21	7541942	50	7550029	149	7551359	167	7912186	165	7932308	103
7536459	21	7541948	56	7550030	149	7551360	167	7912187	165	7932309	103
7536460	21	7542032	52	7550031	149	7551521	149	7912190	165	7932310	103
7536461	59	7542036	52	7550032	149	7551522	149	7912191	165	7932311	103
7536462	21	7542037	52	7550033	149	7551523	149	7912192	165	7932312	103
7536463	21	7542038	52	7550038	151	7551524	149	7912195	165	7932313	103
7536467	20	7542050	52	7550040	151	7551525	149	7912196	165	7932314	103
7536468	20	7542055	52	7550041	151	7551526	149	7912198	165	7932315	102
7536469	59	7542056	52	7550042	151	7551527	149	7912199	165	7932316	102
7536470	20	7542072	52	7550043	151	7551528	149	7912200	165	7932317	102
7536471	20	7542073	52	7550044	151	7551529	149	7912201	165	7932318	102
7536472	68	7542074	52	7550050	151	7551531	149	7912202	165	7932319	102
7536473	20	7542075	52	7550051	151	7551541	149	7912205	165	7932320	102
7536476	20	7542120	52	7550052	151	7551542	149	7912206	165	7932321	102
7536477	20	7542121	52	7550053	148	7551543	149	7912207	165	7932322	102
7536525	68	7542122	52	7550057	148	7551544	149	7912208	164	7932355	92
7536526	68	7542168	53	7550062	149	7551545	149	7912215	164	7932356	92
7536527	68	7542169	53	7550064	149	7551546	149	7912216	164	7932357	92
7536531	68	7542170	53	7550067	149	7551547	149	7912217	164	7932358	92
7536532	68	7542171	53	7550069	149	7551548	149	7912220	165	7932359	92
7536534	68	7542172	53	7550088	149	7551549	149	7912225	164	7932360	92
7536550	23	7542173	53	7550098	149	7551550	149	7912226	164	7932361	169
7536551	23	7542184	53	7550302	148	7552122	167	7912227	164	7932362	92
7536554	23	7542185	53	7550350	150	7552123	167	7912230	164	7932365	93
7536555	23	7542187	53	7550351	150	7552124	167	7912231	164	7932366	93
7536556	23	7542189	53	7550352	150	7552125	167	7912232	164	7932367	93
7536559	23	7542201	53	7550353	150	7552126	167	7912233	164	7932368	93
7536564	23	7542202	53	7550354	150	7553011	209	7930082	184	7932369	93
7536566	23	7542203	53	7550368	148	7553012	209	7930083	184	7932370	93
7541033	47	7542204	53	7550369	148	7553026	209	7930084	184	7932371	93
7541036	160	7542205	53	7550370	150	7553027	209	7930100	184	7932372	93
7541037	160	7542209	53	7550371	150	7911101	240	7930101	184	7932373	97
7541038	160	7542220	158	7550372	150	7911105	240	7930103	184	7932376	97
7541055	55	7542240	53	7550373	150	7911115	240	7930104	184	7932377	97
7541056	55	7542241	53	7550374	150	7911124	240	7932070	99	7932378	97
7541065	47	7542242	53	7550375	150	7911132	240	7932071	99	7932379	97
7541066	47	7542258	60	7550376	150	7911135	239	7932072	99	7932380	97
7541072	47	7542270	53	7550377	150	7911136	239	7932073	99	7932385	96
7541073	47	7542271	53	7550378	150	7911145	240	7932075	98	7932386	96
7541074	47	7542284	60	7550384	148	7911146	240	7932076	98	7932387	96
7541077	47	7542285	60	7550385	148	7911150	166	7932077	98	7932388	96
7541092	46	7542286	60	7550386	148	7911151	166	7932078	98	7932389	96
7541093	71	7542296	53	7550512	151	7911155	240	7932079	98	7932390	96
7541105	167	7542297	53	7550514	151	7911156	240	7932084	169	7935015	12
7541115	46	7542298	53	7550515	151	7911158	240	7932115	100	7935016	12
7541120	44	7542344	52	7550516	151	7911160	166	7932116	100	7935017	12
7541132	54	7542345	52	7550517	151	7911161	166	7932117	100	7935018	59
7541141	71	7542346	52	7550524	167	7911162	239	7932120	100	7935020	12
7541160	61	7542347	52	7550525	151	7911163	239	7932121	100	7935021	12
7541161	61	7543055	54	7550527	151	7911164	239	7932122	100	7935022	12
7541162	61	7543076	17	7550528	151	7911170	240	7932160	98	7935025	13
7541180	46	7543077	17	7550529	151	7911225	254	7932161	98	7935026	13
7541191	160	7543078	17	7550554	151	7911226	257	7932166	99	7935027	13
7541192	61	7543080	17	7550555	151	7911227	257	7932175	90	7935028	59
7541193	61	7543081	17	7550556	151	7911228	254	7932176	90	7935045	12
7541194	61	7543171	17	7550557	151	7911229	257	7932177	90	7935046	12
7541195	61	7543172	17	7550558	151	7911230	254	7932178	90	7935047	12
7541196	61	7543174	17	7550559	151	7911231	256	7932179	91	7935048	59
7541197	61	7543320	15	7550560	151	7911232	254	7932180	169	7935050	13
7541198	61	7543321	15	7550561	151	7911233	257	7932181	91	7935051	13
7541222	44	7543322	15	7550563	151	7911234	256	7932182	169	7935052	13
7541229	243	7543323	15	7550564	151	7911235	257	7932183	91		
7541250	46	75433									



Service Clients : 06.24.33.12.09

lbonnevie@lesartsdemarius.fr

Du Lundi au Samedi

Les Arts de Marius - 13008 Marseille
N°Siren : 919 141 531 - TVA : FR76919141531